

User Manual



TDS5000 Series Digital Phosphor Oscilloscopes

071-0876-01

This document applies to firmware version 1.00
and above.

www.tektronix.com

Copyright © Tektronix, Inc. All rights reserved.

Tektronix products are covered by U.S. and foreign patents, issued and pending. Information in this publication supercedes that in all previously published material. Specifications and price change privileges reserved.

Tektronix, Inc., P.O. Box 500, Beaverton, OR 97077

TEKTRONIX, TEKPROBE, and TEK are registered trademarks of Tektronix, Inc.

Microsoft, Windows, and Windows ME are registered trademarks of Microsoft Corporation.

WARRANTY

Tektronix warrants that the products that it manufactures and sells will be free from defects in materials and workmanship for a period of one (1) year from the date of shipment. If a product proves defective during this warranty period, Tektronix, at its option, either will repair the defective product without charge for parts and labor, or will provide a replacement in exchange for the defective product.

In order to obtain service under this warranty, Customer must notify Tektronix of the defect before the expiration of the warranty period and make suitable arrangements for the performance of service. Customer shall be responsible for packaging and shipping the defective product to the service center designated by Tektronix, with shipping charges prepaid. Tektronix shall pay for the return of the product to Customer if the shipment is to a location within the country in which the Tektronix service center is located. Customer shall be responsible for paying all shipping charges, duties, taxes, and any other charges for products returned to any other locations.

This warranty shall not apply to any defect, failure or damage caused by improper use or improper or inadequate maintenance and care. Tektronix shall not be obligated to furnish service under this warranty a) to repair damage resulting from attempts by personnel other than Tektronix representatives to install, repair or service the product; b) to repair damage resulting from improper use or connection to incompatible equipment; c) to repair any damage or malfunction caused by the use of non-Tektronix supplies; or d) to service a product that has been modified or integrated with other products when the effect of such modification or integration increases the time or difficulty of servicing the product.

THIS WARRANTY IS GIVEN BY TEKTRONIX IN LIEU OF ANY OTHER WARRANTIES, EXPRESS OR IMPLIED. TEKTRONIX AND ITS VENDORS DISCLAIM ANY IMPLIED WARRANTIES OF MERCHANTABILITY OR FITNESS FOR A PARTICULAR PURPOSE. TEKTRONIX' RESPONSIBILITY TO REPAIR OR REPLACE DEFECTIVE PRODUCTS IS THE SOLE AND EXCLUSIVE REMEDY PROVIDED TO THE CUSTOMER FOR BREACH OF THIS WARRANTY. TEKTRONIX AND ITS VENDORS WILL NOT BE LIABLE FOR ANY INDIRECT, SPECIAL, INCIDENTAL, OR CONSEQUENTIAL DAMAGES IRRESPECTIVE OF WHETHER TEKTRONIX OR THE VENDOR HAS ADVANCE NOTICE OF THE POSSIBILITY OF SUCH DAMAGES.

Table of Contents

General Safety Summary	xi
Preface	xiii
About This Manual	xiii
Related Manuals and Online Documents	xiv
Contacting Tektronix	xv

Getting Started

Product Description	1-1
Models	1-1
Key Features	1-1
Product Software	1-2
Firmware Upgrade	1-3
Probes Supported	1-4
Installation	1-5
Unpacking	1-5
Checking the Environment Requirements	1-6
Connecting Peripherals	1-6
Powering On the Oscilloscope	1-8
Shutting Down the Oscilloscope	1-9
Creating an Emergency Startup Disk	1-9
Backing Up User Files	1-10
Installing Software	1-10
Connecting to a Network	1-12
Setting up a Dual Display	1-13
Adjusting Display Contrast	1-17
Incoming Inspection	1-19
Assemble Equipment	1-19
Self Tests	1-20
Functional Tests	1-21
Perform the Extended Diagnostics	1-30
Accessories and Options	1-31
Options	1-31
Accessories	1-33

Operating Basics

Operational Maps	2-1
Documentation Map	2-2
Front Panel I/O Map	2-3
Control Panel Map: Quick Access to Most Often Used Features ...	2-4
User Interface Map - Complete Control and Display	2-5
Display Map - Single Graticule	2-6
Side and Rear Panel I/O & Connectors Map	2-7
Left Side	2-7

Rear	2-7
System Overview Maps	2-8
Functional Model Map	2-8
Process Overview Map	2-10

Reference

Overview	3-1
Acquiring Waveforms	3-3
Signal Connection and Conditioning	3-4
Connecting and Conditioning Your Signals	3-5
Setting Up Signal Input	3-8
Autosetting the Oscilloscope	3-12
Resetting the Oscilloscope	3-13
Input Conditioning Background	3-14
Setting Acquisition Controls	3-21
Acquisition Modes	3-21
Controlling Acquisitions	3-22
Roll Mode	3-22
Preventing Aliasing	3-23
Incompatible Modes	3-24
Setting Acquisition Modes	3-25
Starting and Stopping Acquisition	3-26
Using Roll Mode	3-28
Acquisition Control Background	3-29
Acquisition Hardware	3-30
Sampling Process	3-30
Sampling Modes	3-31
Waveform Record	3-31
Real-time Sampling	3-32
Equivalent-time Sampling	3-33
Interpolation	3-34
Interleaving	3-35
Using Fast Acquisitions Mode	3-35
Using Fast Acquisitions	3-36
Turning Fast Acquisitions On and Off	3-39
Setting the Display Format	3-41
Using FastFrame	3-42
Using FastFrame Acquisitions	3-43
To Set FastFrame Mode	3-44
Time Stamping Frames	3-45
Triggering	3-49
Triggering Concepts	3-50
Trigger Event	3-50
Trigger Sources	3-50
Trigger Types	3-51
Trigger Modes	3-51
Trigger Holdoff	3-52
Trigger Coupling	3-52
Horizontal Position	3-53
Slope and Level	3-53
Delayed Trigger System	3-53

Triggering from the Front Panel	3-54
Setting up Triggers	3-54
Checking Trigger Status	3-57
Additional Trigger Parameters	3-59
Advanced Triggering	3-62
Triggering on a Glitch	3-68
Triggering on a Runt Pulse	3-70
Triggering on the Pulse Width	3-73
Triggering on Transition Time	3-75
Triggering on Pulse Timeout	3-77
Triggering on a Pattern	3-79
Triggering on Logic State	3-82
Triggering on Setup/Hold Time Violations	3-84
Triggering on Window Threshold Violations	3-87
Triggering on a Video Signal	3-89
Sequential Triggering	3-91
Using Sequential Triggering	3-91
Triggering on a Sequence	3-95
Displaying Waveforms	3-99
Using the Waveform Display	3-100
Display Elements	3-100
Acquisition Preview	3-101
Display Methods	3-101
Displaying Waveforms in the Main Graticule	3-104
Customizing the Waveform Display	3-106
Using Display Controls	3-106
Using the Zoom Feature	3-110
Using Zoom with Waveforms	3-110
Measuring Waveforms	3-115
Taking Automatic Measurements	3-115
Using Automatic Measurements	3-116
Taking Automatic Measurements	3-119
Localizing a Measurement	3-122
Taking Cursor Measurements	3-124
Cursor Types	3-124
Using Cursors	3-125
Setting Cursor Sources	3-128
Using Histograms (Optional)	3-130
Starting and Resetting Histogram Counting	3-132
Histogram Measurements	3-133
Creating and Using Math Waveforms	3-135
About Math Waveforms	3-136
Purpose	3-136
Standard Math versus Advanced Math	3-137
Other Uses for Math Waveforms	3-138
Using Math	3-138
Creating a Math Waveform	3-144
Operations on Math Waveforms	3-147
Displaying and Measuring Math Waveforms	3-148
Defining Spectral Math Waveforms	3-151

Using Spectral Math Controls	3-152
Recognizing Aliasing	3-172
Selecting a Predefined Spectral Math Function (Optional)	3-174
Defining a Spectral Math Waveform	3-175
Defining a Spectral Math Waveform (Optional)	3-176
Data Input/Output	3-183
Saving and Recalling Setups	3-183
Saving A Setup	3-185
Recalling a Setup	3-187
Saving and Recalling Waveforms	3-189
Saving a Waveform	3-190
Recalling A Waveform	3-192
Clearing References	3-194
Exporting and Copying Waveform Data	3-196
Exporting Waveform Data	3-197
Using an Exported Waveform	3-200
Copying Waveform Data	3-202
Printing Waveforms	3-205
Printing from the Front Panel	3-205
Printing from the Menu Bar	3-205
Setting Up the Page	3-205
Previewing the Page	3-205
Printing Banners	3-206
Using Print Screen	3-207
Using the Date/Time Stamp	3-207
Remote Communication	3-207
GPIB	3-207
Other Communication	3-208
Accessing Online Help	3-209
Using Online Help	3-209

Appendices

Appendix A: Specifications	A-1
Product and Feature Description	A-1
Acquisition Features	A-2
Signal Processing Features	A-2
Display Features	A-3
Measurement Features	A-3
Trigger Features	A-3
Convenience Features	A-3
Specification Tables	A-5
Appendix B: Automatic Measurements Supported	B-1
Appendix C: Cleaning	C-1
Exterior Cleaning	C-1
Flat Panel Display Cleaning	C-1
Appendix D: Menu Bar Commands	D-1
File Commands	D-1
Edit Commands	D-2
Vertical Commands	D-3
Horizontal and Acquisition Commands	D-4

Trigger Commands	D-5
Display Commands	D-6
Cursors Commands	D-7
Measure Commands	D-7
Standard Math Commands	D-8
Advanced Math Commands (Optional)	D-9
Utilities Commands	D-10
Help Commands	D-10
Appendix E: Optimizing Measurement Accuracy	E-1
Compensating the Oscilloscope	E-1
Connecting Probes for Calibration	E-3
Calibrating Probes	E-3
Compensating Low Frequency Probes	E-5
Deskewing Channels	E-6

Glossary

Index

List of Figures

Figure 1-1: Locations of connectors on side and rear panels	1-7
Figure 1-2: On/Standby switch location	1-8
Figure 1-3: Drag area for Windows task bar	1-16
Figure 1-4: Universal test hookup for functional tests, CH 1 shown	1-22
Figure 1-5: Channel button location	1-22
Figure 1-6: Location of vertical and horizontal scale readouts	1-23
Figure 1-7: Setup for time base test	1-25
Figure 1-8: Setup for trigger test	1-27
Figure 1-9: Setup for the file system test	1-29
Figure 3-1: Oscilloscope System Overview: Signal Acquisition	3-3
Figure 3-2: Input and Acquisition Systems and Controls	3-4
Figure 3-3: Setting vertical range and position of input channels ..	3-16
Figure 3-4: Varying offset moves the vertical acquisition window on the waveform	3-17
Figure 3-5: Horizontal acquisition window definition	3-18
Figure 3-6: Common trigger, record length, and acquisition rate for all channels	3-20
Figure 3-7: Roll modes	3-23
Figure 3-8: Aliasing	3-24
Figure 3-9: Digitizer configuration	3-30
Figure 3-10: Digital acquisition — sampling and digitizing	3-30
Figure 3-11: The waveform record and its defining parameters (horizontal delay on)	3-32
Figure 3-12: Real-time sampling	3-32
Figure 3-13: Equivalent-time sampling	3-33
Figure 3-14: Normal DSO and Fast Acquisitions displays	3-36
Figure 3-15: Normal DSO Acquisition and Display mode versus Fast Acquisitions mode	3-38
Figure 3-16: Fast Acquisitions XY display	3-41
Figure 3-17: FastFrame	3-42
Figure 3-18: FastFrame time stamp	3-48
Figure 3-19: Oscilloscope System Overview: Triggering	3-49
Figure 3-20: Triggered versus untriggered displays	3-50
Figure 3-21: Holdoff adjustment can prevent unwanted triggers ..	3-52

Figure 3-22: Slope and level controls help define the trigger	3-53
Figure 3-23: Example advanced trigger readout	3-62
Figure 3-24: Violation zones for Setup/Hold triggering	3-66
Figure 3-25: Triggering on a Setup/Hold time violation	3-86
Figure 3-26: Triggering with Horizontal Delay off	3-92
Figure 3-27: Triggering with Horizontal Delay on	3-93
Figure 3-28: Trigger and Horizontal Delay summary	3-94
Figure 3-29: Oscilloscope System Overview: Customizable Display	3-99
Figure 3-30: Display elements	3-100
Figure 3-31: Horizontal position includes time to horizontal reference point	3-103
Figure 3-32: Annotated display	3-115
Figure 3-33: High/Low tracking methods	3-117
Figure 3-34: Reference level calculation methods	3-118
Figure 3-35: Components determining Time cursor readout values	3-126
Figure 3-36: Horizontal histogram view and measurement data ...	3-131
Figure 3-37: Math waveform created from source waveform	3-135
Figure 3-38: Spectral analysis of an impulse	3-136
Figure 3-39: Functional transformation of an acquired waveform .	3-136
Figure 3-40: Derivative math waveform	3-141
Figure 3-41: Peak-peak amplitude measurement of a derivative waveform	3-142
Figure 3-42: Duration and resolution control effects	3-153
Figure 3-43: Definition of gate parameters	3-154
Figure 3-44: Effects of frequency domain control adjustments	3-156
Figure 3-45: Effects of adjusting the reference level	3-157
Figure 3-46: Effects of adjusting the reference level offset control .	3-158
Figure 3-47: Example of the effects of setting the phase suppression threshold	3-159
Figure 3-48: Windowing the time domain record	3-161
Figure 3-49: Example of scallop loss for a Hanning window without zero fill	3-163
Figure 3-50: Time and frequency graphs for the Gaussian window	3-164
Figure 3-51: Time and frequency domain graphs for the Rectangular window	3-165
Figure 3-52: Time and frequency graphs of the Hamming window	3-166

Figure 3-53: Time and frequency graphs for the Hanning window	3-167
Figure 3-54: Time and frequency graphs for the Kaiser-Bessel window	3-168
Figure 3-55: Time and frequency graphs of the Blackman-Harris window	3-169
Figure 3-56: Time and frequency domain graphs for the Flattop2 window	3-170
Figure 3-57: Tek Exponential window in the time and the frequency domains	3-171
Figure 3-58: How aliased frequencies appear in a spectral waveform	3-173
Figure 3-59: Auto-increment file name feature	3-184
Figure 3-60: Print preview dialog box	3-206
Figure B-1: Levels used to determine measurements	B-3

List of Tables

Table 1-1: Recommended probe cross reference	1-4
Table 1-2: Additional accessory connection information	1-7
Table 1-3: Instrument options	1-31
Table 1-4: Instrument upgrades	1-32
Table 1-5: Standard accessories	1-33
Table 1-6: Optional accessories	1-34
Table 3-1: Additional resolution bits	3-21
Table 3-2: Sampling mode selection	3-34
Table 3-3: How interleaving affects sample rate	3-35
Table 3-4: XY format pairs	3-42
Table 3-5: Pattern and state logic	3-64
Table 3-6: Defining and displaying waveforms	3-101
Table 3-7: Customizable display elements	3-106
Table 3-8: Cursor types	3-124
Table 3-9: Cursor units	3-126
Table 3-10: Functions available in Standard Math and Advanced Math	3-137
Table 3-11: Math expressions and the math waveforms produced	3-138
Table 3-12: Spectral analyzer controls	3-152
Table 3-13: Window characteristics	3-161
Table A-1: TDS5000 models	A-1
Table A-2: Channel input and vertical specifications	A-5
Table A-3: Horizontal and acquisition system specifications	A-11
Table A-4: Trigger specifications	A-13
Table A-5: Display specifications	A-16
Table A-6: Input/output port specifications	A-17
Table A-7: Data storage specifications	A-18
Table A-8: Power source specifications	A-19
Table A-9: Mechanical specifications	A-19
Table A-10: Environmental specifications	A-20
Table A-11: Certifications and compliances	A-21
Table B-1: Supported measurements and their definitions	B-1

Table D-1: File menu commands	D-1
Table D-2: Edit menu commands	D-2
Table D-3: Vertical menu commands	D-3
Table D-4: Horiz/Acq menu commands	D-4
Table D-5: Trig menu commands	D-5
Table D-6: Display menu commands	D-6
Table D-7: Cursors menu commands	D-7
Table D-8: Measure menu commands	D-7
Table D-9: Standard Math menu commands	D-8
Table D-10: Advanced Math menu commands	D-9
Table D-11: Utilities menu commands	D-10
Table D-12: Help menu commands	D-10

General Safety Summary

Review the following safety precautions to avoid injury and prevent damage to this product or any products connected to it. To avoid potential hazards, use this product only as specified.

Only qualified personnel should perform service procedures.

While using this product, you may need to access other parts of the system. Read the *General Safety Summary* in other system manuals for warnings and cautions related to operating the system.

To Avoid Fire or Personal Injury

Use Proper Power Cord. Use only the power cord specified for this product and certified for the country of use.

Connect and Disconnect Properly. Do not connect or disconnect probes or test leads while they are connected to a voltage source.

Ground the Product. This product is grounded through the grounding conductor of the power cord. To avoid electric shock, the grounding conductor must be connected to earth ground. Before making connections to the input or output terminals of the product, ensure that the product is properly grounded.

Observe All Terminal Ratings. To avoid fire or shock hazard, observe all ratings and markings on the product. Consult the product manual for further ratings information before making connections to the product.

Do Not Operate Without Covers. Do not operate this product with *metal* covers or panels removed.

Avoid Exposed Circuitry. Do not touch exposed connections and components when power is present.

Do Not Operate With Suspected Failures. If you suspect there is damage to this product, have it inspected by qualified service personnel.

Do Not Operate in Wet/Damp Conditions.

Do Not Operate in an Explosive Atmosphere.

Keep Product Surfaces Clean and Dry.

Provide Proper Ventilation. Refer to the manual's installation instructions for details on installing the product so it has proper ventilation.

Symbols and Terms

Terms in this Manual. These terms may appear in this manual:



WARNING. *Warning statements identify conditions or practices that could result in injury or loss of life.*



CAUTION. *Caution statements identify conditions or practices that could result in damage to this product or other property.*

Terms on the Product. These terms may appear on the product:

DANGER indicates an injury hazard immediately accessible as you read the marking.

WARNING indicates an injury hazard not immediately accessible as you read the marking.

CAUTION indicates a hazard to property including the product.

Symbols on the Product. The following symbols may appear on the product:



CAUTION
Refer to Manual



WARNING
High Voltage



Protective Ground
(Earth) Terminal

Preface

This is the user manual for the TDS5000 Series oscilloscope. It covers the following information:

- Describes the capabilities of the oscilloscope and how to get started using the instrument
- Explains how to operate the oscilloscope: how to control acquisition of, processing of, and input/output of data and information
- Lists specifications and accessories of the oscilloscope

About This Manual

This manual is composed of the following chapters:

- *Getting Started* shows you how to configure and install your oscilloscope and provides an incoming inspection procedure.
- *Operating Basics* uses maps to describe the various interfaces for controlling the oscilloscope, including the front panel and the software user interface. These maps provide overviews of the product and its functions from several viewpoints.
- *Reference* comprises an encyclopedia of topics (see *Overview* on page 3-1) that describe the oscilloscope interface and features, and gives background and basic information on how to use them. (The online help onboard the oscilloscope application describes the interface, features, and their usage; detailed descriptions of all programming commands are found in the *TDS5000 Series Oscilloscope Online Programmer Guide*.)
- *Appendices* provides additional information including instrument specifications, measurement and menu descriptions, cleaning information, and calibration instructions.

Related Manuals and Online Documents

This manual is part of a document set of standard-accessory manuals and online documentation; this manual mainly focuses on installation, background, and user information needed to use the product features. See the following list for other documents supporting oscilloscope operation and service. (Manual part numbers are listed in *Accessories & Options* on page 1-31.)

Manual name	Description
<i>TDS5000 Series Digital Phosphor Oscilloscopes Online Help</i>	An online help system, integrated with the User Interface application that ships with this product. The help is preinstalled in the oscilloscope.
<i>TDS5000 Series Digital Phosphor Oscilloscopes Reference Manual</i>	A quick reference to major features of the oscilloscope and how they operate.
<i>TDS5000 Series OscilloscopeOnline Programmer Guide</i>	A listing of the programming commands and other information related to controlling the oscilloscope over GPIB ¹ .
<i>TDS5000 Series Digital Phosphor Oscilloscopes Service Manual</i>	A description of how to service the oscilloscope to the module level. This optional manual must be ordered separately.

1 Located on the TDS5000 Series Product Software CD. See CD instructions for installation instructions.

For more information on how the product documentation relates to the oscilloscope operating interfaces and features, see *Documentation Map* on page 2-2.

Contacting Tektronix

Phone	1-800-833-9200*
Address	Tektronix, Inc. Department or name (if known) 14200 SW Karl Braun Drive P.O. Box 500 Beaverton, OR 97077 USA
Web site	www.tektronix.com
Sales support	1-800-833-9200, select option 1*
Service support	1-800-833-9200, select option 2*
Technical support	Email: techsupport@tektronix.com 1-800-833-9200, select option 3* 6:00 a.m. - 5:00 p.m. Pacific time

- * **This phone number is toll free in North America. After office hours, please leave a voice mail message. Outside North America, contact a Tektronix sales office or distributor; see the Tektronix web site for a list of offices.**

Product Description

This chapter describes the TDS5000 Series Digital Phosphor Oscilloscopes and their options. Following this description are three sections:

- *Installation* shows you how to configure and install the oscilloscope, as well as how to reinstall the system software included with the product.
- *Incoming Inspection* provides a procedure for verifying basic operation and functionality.
- *Accessories* lists the standard and optional accessories for this product.

Models

This manual supports three very similar oscilloscopes:

- TDS5052 Digital Phosphor Oscilloscope
- TDS5054 Digital Phosphor Oscilloscope
- TDS5104 Digital Phosphor Oscilloscope

This user manual applies to all of the above oscilloscopes: differences between the oscilloscopes are noted when necessary.

Key Features

TDS5000 Series oscilloscopes are high-performance solutions for verification, debugging, and characterization of sophisticated electronic designs. The series features exceptional signal acquisition performance, operational simplicity, and open connectivity to the design environment. Classic analog-style controls, a large display with an optional touch-sensitive screen, and graphical menus provide intuitive control. Open access to the Windows operating system enables unprecedented customization and extensibility. Key features include:

- Up to 1 GHz bandwidth and 5 GS/s real time sampling rate, depending on the model
- Record lengths up to 8,000,000 samples, depending on memory option
- Fast acquisition at up to 100,000 acquisitions per second for analog oscilloscope emulation and isolation of data-dependent failures during conformance/performance testing
- 1.5% DC vertical gain accuracy

- Two or four input channels (each with 8-bit resolution), Channel 3 signal output (depending on model), and auxiliary trigger input and output
- Sample, envelope, peak-detect, high-resolution, and average acquisition modes
- Full programmability, with an extensive GPIB command set and a message-based interface
- Extensive suite of advanced triggers including edge, logic, pulse, video, and sequence at up to 1 GHz bandwidth
- Powerful built-in measurement capability, including optional histograms, automatic measurements, and measurement statistics
- A large 10.4 inch (264.2 mm) color display that supports color grading of waveform data to show sample density
- An intuitive graphical user interface (UI) with online help
- Internal disk storage
- Wide array of probing solutions
- Optional integrated thermal printer
- Optional touch screen
- Optional CD-RW drive

Product Software

The oscilloscope includes the following software:

- **System Software.** The product software runs on a specially configured version of Windows 2000. Windows 2000 is preinstalled and enables you to install other compatible applications. To reinstall Windows 2000, use the Operating System Restore CD-ROM, a standard accessory with your oscilloscope. Do not attempt to substitute any version of Windows that is not specifically provided by Tektronix for use with your oscilloscope. (Note that older versions of the instrument may use Windows ME; contact Tektronix sales support for information about upgrading an older instrument to Windows 2000.)
- **TDS5000 Product Software.** This preinstalled software is the oscilloscope application and runs on Windows 2000. It provides the user interface (UI) and all other oscilloscope control functions. You can minimize or even exit/restart the oscilloscope application as your needs dictate. However, it is recommended that you exit the oscilloscope application only when installing new software.

- Support Software. The *TDS5000 Series Product Software* CD-ROM, included with the oscilloscope, contains additional software and files that may be useful to you.
 - Readme file. This text file contains release notes and updates that are not included in other product documentation.
 - GPIB Programmer Online Help software. This software is available as WinHelp or as a PDF file. It contains the information you need to program the oscilloscope through its GPIB interface.
 - Performance Verification Procedures. The product CD-ROM contains instructions to perform a manual performance verification.

See the instructions for the *TDS5000 Series Product Software* CD-ROM for information about installing the support software.

Occasionally new versions of software for your oscilloscope may become available at our web site. See *Contacting Tektronix* on page xv in the Preface.

Firmware Upgrade

Tektronix may offer firmware upgrade kits for the oscilloscope. Contact your Tektronix service representative for more information (see *Contacting Tektronix* on page xv).

Probes Supported

Table 1-1 lists the recommended probes for each oscilloscope. Descriptions of each probe follow the table.

Table 1-1: Recommended probe cross reference

Probe	TDS5052	TDS5054	TDS5104
Passive, 10X	P5050	P5050	P5050
Passive, 100X	P5100	P5100	P5100
Passive, 1000K	P6015A	P6015A	P6015A
Active CMOS/TTL	P6243	P6243	P6245
All Technology	P6245	P6245	P6245
Differential Digital	P6246, P6247, P6248	P6246, P6247, P6248	P6246, P6247, P6248
High Voltage Differential	P5205, P5210	P5205, P5210	P5205, P5210
Current, AC Only	CT-6	CT-6	CT-6
Current, AC/DC	TCP202	TCP202	TCP202
Low Capacitance	P6158	P6158	P6158

- P5050 10X, 500 MHz passive probe
- P5100 100X, 250 MHz passive high voltage probe
- P6015A 1000X, 100 MHz passive high voltage probe
- P6243 Active, high speed digital voltage probe, FET, DC to 1.0 GHz
- P6245 Active, high speed digital voltage probe, FET, DC to 1.5 GHz
- P6246 Active, high bandwidth differential probe, FET, DC to 400 MHz
- P6247 Active, high bandwidth differential probe, FET, DC to 1 GHz
- P6248 Active, high bandwidth differential probe, FET, DC to 1.7 GHz
- P5205 Active 100 MHz differential probe
- P5210 Active, 50 MHz differential probe
- TCP202 Current Probe, DC to 50 MHz, 15 A DC
- CT-6 Current probe, designed for temporary in-circuit installation, 250 kHz to 2 GHz, 50 Ω input
- P6158 20X, 3 GHz low capacitance probe

Installation

This section addresses oscilloscope installation:

- *Unpacking* on page 1-5
- *Checking the Environment Requirements* on page 1-6
- *Connecting Peripherals* on page 1-6
- *Powering On the Oscilloscope* on page 1-8
- *Shutting Down the Oscilloscope* on page 1-9
- *Creating an Emergency Startup Disk* on page 1-9
- *Backing Up User Files* on page 1-10
- *Installing Software* on page 1-10
- *Connecting to a Network* on page 1-12
- *Setting Up a Dual Display* on page 1-13
- *Adjusting Display Contrast* on page 1-17



CAUTION. Be sure to create your emergency startup disk as described on page 1-9. You may need that disk if you ever need to reinstall Windows 2000 on the oscilloscope hard drive.

Unpacking

The graphical packing list shows the standard accessories that you should find in the shipping carton. The number of probes depends on the model you ordered. You should verify that you have:

- The correct power cord for your geographical area.
- Four compact discs that include copies of the software installed on the oscilloscope and additional support software that may be useful to you: *TDS5000 Series Operating System Restore* (two CDs), *TDS5000 Series Product Software*, and *Optional Applications Software for Tektronix Windows-Based TDS Instruments*. Store the product software in a safe location.
- All the standard and optional accessories that you ordered.

Remember to fill out and send in the customer registration card. The registration card is packaged with this manual.

Checking the Environment Requirements

Read this section before attempting any installation procedures. This section describes site considerations, power requirements, and ground connections for your oscilloscope.

Site Considerations

The oscilloscope is designed to operate on a bench or on a cart in the normal position (on the bottom feet). For proper cooling, at least three inches (7.62 cm) of clearance is required on the left side of the oscilloscope. The bottom and rear require the clearance provided by the oscilloscope feet.



CAUTION. *To ensure proper cooling, keep the bottom and left side of the oscilloscope clear of obstructions.*

Operating Requirements

The Specifications in Appendix A list the power source, temperature, humidity, and altitude operating requirements for the oscilloscope.

Connecting Peripherals

The peripheral connections are the same as those on a personal computer. The connection points are shown in Figure 1-1. See Table 1-2 on page 1-7 for additional connection information.

NOTE. *We recommend that you plug USB devices directly into the USB connectors on the oscilloscope chassis for improved reliability rather than connecting the devices serially. If your USB mouse locks up, disconnect and reconnect the USB connector to restore normal operation. If the oscilloscope front panel and/or touch screen do not respond, press the On/Standby switch for at least 5 seconds to cycle power.*



CAUTION. To avoid product damage, shut down the oscilloscope and disconnect the power cord from the power source before connecting any accessories. A USB mouse, keyboard, or other USB device can be connected or disconnected with the power on. See Shutting Down the Oscilloscope on page 1-9.

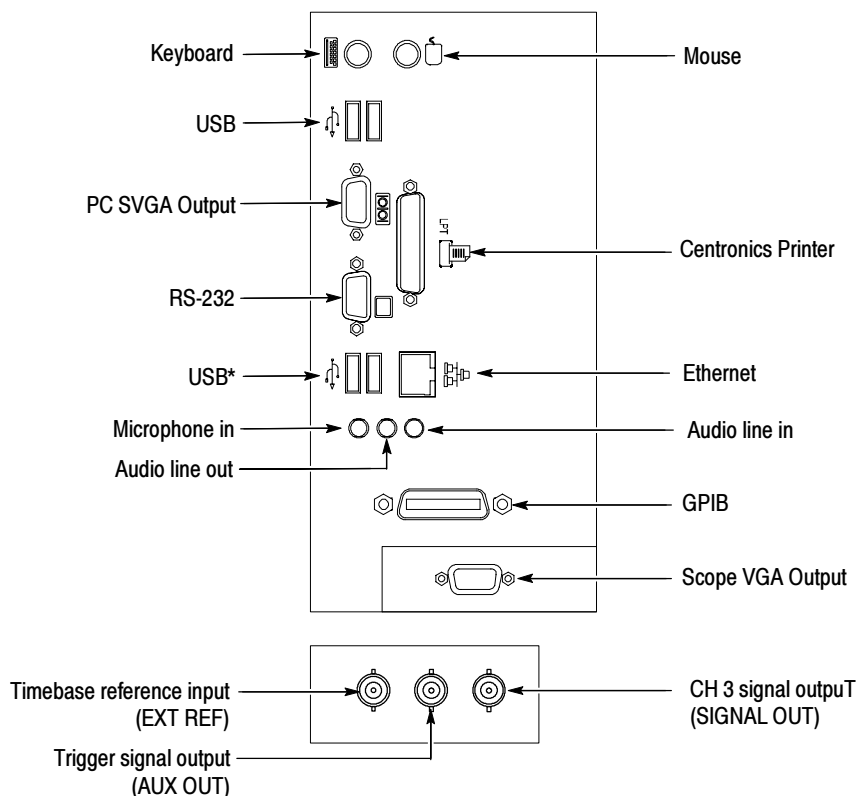

*These connectors are on later model instruments only.

Figure 1-1: Locations of connectors on side and rear panels

Table 1-2: Additional accessory connection information

Item	Description
Monitor	If you use a nonstandard monitor, you may need to change the Windows 2000 display settings to achieve the proper resolution for your monitor.
Printer	Connect an external printer to the Centronics parallel port connector directly. If your printer has a DB-25 connector, use the adapter cable that came with your printer. For information on printer usage, see <i>Printing Waveforms</i> on page 3-205.

Table 1-2: Additional accessory connection information (Cont.)

Item	Description
Rackmount	For installation information, refer to the instructions that came with your rackmount kit.
Other	Refer to the Readme file on the <i>TDS5000 Series Product Software</i> CD for possible additional accessory installation information not covered in this manual.

Powering On the Oscilloscope

Follow these steps to power on the oscilloscope for the first time.



CAUTION. To ensure proper operation, connect the keyboard, mouse, and other accessories before applying power to the product the first time.

1. Connect the one end of the oscilloscope power cord to the oscilloscope, and the other end to a power source.
2. If you have connected an external monitor, connect the monitor power cord to a power source and power on the monitor.
3. Push the On/Standby switch to power on the oscilloscope (see Figure 1-2 for the switch location).

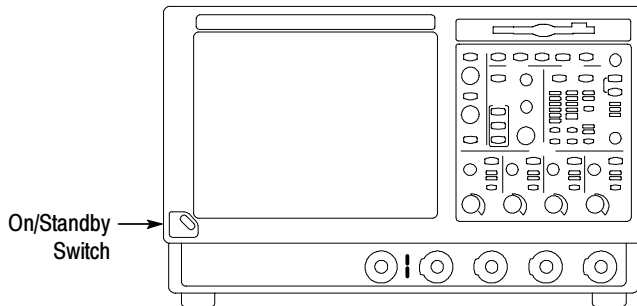

Figure 1-2: On/Standby switch location

Shutting Down the Oscilloscope

When you push the front-panel On/Standby switch, the oscilloscope starts a shutdown process (including a Windows shutdown) to preserve settings and then go into standby mode. Avoid disconnecting the power cord to shut down the oscilloscope.

NOTE. *If you remove power instead of using the On/Standby switch to shut down the oscilloscope, the oscilloscope will be in the factory Default Setup when powered up the next time.*

It may be necessary to hold the On/Standby switch for up to 20 seconds for the shutdown process to initiate.

To completely remove power to the oscilloscope, perform the shutdown process just described and disconnect the power cord from the power source.

Creating an Emergency Startup Disk

Now that you have completed the basic installation process, you should create an emergency startup disk that you can use to restart your oscilloscope in case of a major hardware or software failure. Store this disk in a safe place.



CAUTION. *Create this disk and store it in a safe place. It may allow you to recover your Windows 2000 installation without rebuilding the entire oscilloscope hard disk.*

The emergency startup disk contains basic files to restart your oscilloscope. The disk also contains files to check and format the hard disk.

Windows ME

Follow these steps to create the emergency startup disk for an instrument using Windows ME:

1. Minimize the oscilloscope application by selecting **Minimize** in the File menu.
2. Click the Windows **Start** button, point to **Settings**, and click **Control Panel**.
3. In the Control Panel window, double-click **Add/Remove Programs**.
4. Click the **Startup Disk** tab.
5. Insert a floppy disk into the disk drive, and follow the on-screen instructions to create the startup disk.

Windows 2000

Follow these steps to create the emergency startup disk for an instrument using Windows 2000:

1. Minimize the oscilloscope application by selecting **Minimize** in the File menu.
2. From the Windows taskbar, select **Start, Programs, Accessories, System Tools, Backup**.
3. In the Welcome display, click **Emergency Repair Disk**.
4. Insert a floppy disk into the disk drive, and follow the on-screen instructions to create the startup disk.

Backing Up User Files

Always back up your user files on a regular basis. Use the Windows Backup tool to back up files stored on the hard disk. The BackUp tool is located in the System Tools folder in the Accessories folder.

Use these steps to back up your files:

1. Exit the oscilloscope application by selecting the File menu **Exit** command.
2. Click the Windows **Start** button.
3. Select **Programs, Accessories, System Tools, Backup**.
4. Use the Backup Wizard to select the items you want to back up and the destination. You can back up to the floppy drive, or to a third-party storage device over one of the side-panel ports.

Installing Software

The oscilloscope system and application software is preinstalled at the factory. If you have to reinstall the software for any reason, refer to the instructions that accompany the CD-ROMs shipped with the oscilloscope.

Software Release Notes

Read the software release notes (README.TXT) on the product software CD-ROM before performing installation procedures. This file contains additional information that supercedes other product documentation.

To view README.TXT, start the Windows Notepad accessory and open the file from the *TDS5000 Series Product Software* CD-ROM.

Accessory Software

The *TDS5000 Series Product Software* CD-ROM contains accessory software and files that you can install on the oscilloscope or another PC. Refer to the instructions that accompany the CD-ROM for installation information.

TDS5000 Series Programmer Online Guide. The GPIB programmer information is available as a separate WinHelp file that you can install and access from the Help menu GPIB Online command. For your convenience, you can also install it on the GPIB system controller PC.

From the system controller PC, you can copy and paste commands from the online help file directly into your test programs. The programmer information contains:

- GPIB configuration information for the oscilloscope
- Lists of the command groups and the commands they contain
- Detailed command descriptions including syntax and examples
- Status and error messages
- Programming examples

The programmer information is also available as a PDF file on the *TDS5000 Series Product Software* CD-ROM.

Manual Performance Verification Procedure. This is a printable PDF file that describes a manual method to verify the oscilloscope performance using generic test equipment.

Optional Application Trial Versions

The *Optional Applications Software for Tektronix Windows-Based TDS Instruments* CD-ROM contains trial versions of useful programs that you can install and run five times per application. You can then purchase an upgrade from Tektronix if you decide that you want to continue to use the application. Refer to the instructions that accompany the CD-ROM for installation information.

Desktop Applications

You can install desktop application software on the oscilloscope. The oscilloscope has been tested with the following software products installed:

- Microsoft Office 98 (Word, Excel, PowerPoint, etc.)
- MathCad
- MATLAB

Other software products may be compatible but have not been tested by Tektronix. If the oscilloscope malfunctions after you install software, uninstall the software and then reinstall the oscilloscope application to restore proper operation.

Exiting the Oscilloscope Application. Before installing other desktop applications, exit the oscilloscope application. To do this, select the File menu **Exit** command.

TDS5000 Options and Upgrades

Some TDS5000 options and upgrades contain software that needs to be installed and/or enabled. Follow the specific instructions that come with the option.

Tektronix provides a key that you must enter (one time) to enable all options or upgrades that you have purchased. To enter the key, select the Option Installation command from the Utility menu of the oscilloscope application, and follow the on-screen instructions.

Connecting to a Network

You can connect the oscilloscope to a network to enable printing, file sharing, internet access, and other communications functions. Before you make the connection, do the following steps to enable network access to the oscilloscope:

1. Begin with the oscilloscope power off.
2. Attach a keyboard and mouse to the oscilloscope.
3. Power on the oscilloscope.
4. As the oscilloscope begins to boot, press the keyboard **F2** key repeatedly until the message “Loading SETUP” appears.
5. In the BIOS Setup Utility, use the keyboard right-arrow key to highlight the **Advanced** menu at the top of the screen.
6. Use the arrow down key to highlight **Peripheral Configuration** in the Advanced screen, and then press **Enter**.
7. Use the arrow down key to highlight **LAN Device** in the Peripheral Configuration screen, and then press **Enter**.
8. Use the arrow up or down key to highlight **Enabled**, and then press **Enter**.
9. Press the **F10** key to save and exit. Confirm the Save of Configuration changes when you are prompted on screen.

10. Use the Windows network setup utility to define the oscilloscope as a network client, and configure it for your network. You can find the network setup utility in the Windows **Start** menu if you select **Settings > Control Panel** and then double click **Network**. You should consult your network administrator for specific instructions to make these settings.

NOTE. *If you want to disable network access for the oscilloscope, perform the above procedure, except substitute Disabled for the command listed in step 8. The oscilloscope will boot faster with network access disabled.*

Setting up a Dual Display

Dual display lets you view Windows and other applications on an external monitor while running the oscilloscope. You can also drag up to five dockable control windows from the TekScope application onto the display of the second monitor. For example, this feature allows you to have the Horizontal/Acquisition, the Horizontal Zoom, and the Display Setup Control Windows (half screen) open on the second monitor at the same time.

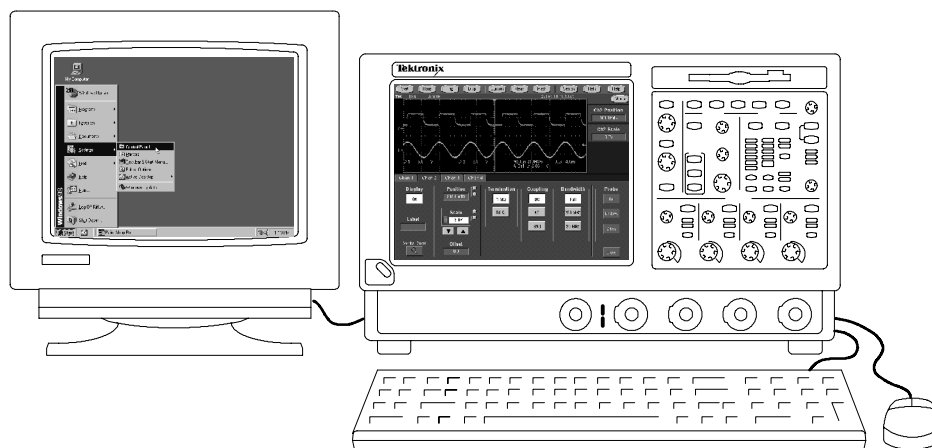

Windows ME

If your instrument is using Windows ME, use the following steps to set up the oscilloscope for dual display operation:

1. Disconnect the oscilloscope power cord from the power source so that you can connect an external monitor.
2. Connect a keyboard and mouse to the oscilloscope.

3. Connect an external monitor to the upper SVGA port on the side panel of the oscilloscope.
4. Connect the oscilloscope power cord to the power source, and power on the oscilloscope and the external monitor.
5. The oscilloscope should detect that the new monitor is connected. Follow the instructions on the oscilloscope screen to install new drivers for the monitor.
6. Type **Ctrl+M** or select **Minimize** from the File menu to minimize the oscilloscope application.
7. On the Windows desktop, right click the mouse and select **Properties** to open the Display Properties dialog box.
8. Select the **Settings** tab and click the disabled monitor in the display box.
9. Click **Yes** when you are prompted to enable the new monitor.
10. Set the resolution that you want to use on the external monitor (16 bit or better).
11. Click on the external monitor in the display box, and drag the external monitor to the correct orientation.



CAUTION. Do not change the resolution settings for the internal LCD monitor. The internal resolution must be 640 x 480. The colors must be set to High Color (16 bit). If you use other settings, the video port may not work properly.

12. Click **OK** to apply the settings.
13. Reboot your instrument. The new monitor will display additional desktop area.

Windows 2000

If your instrument is using Windows 2000, use the following steps to set up the oscilloscope for dual display operation:

1. Disconnect the oscilloscope power cord from the power source so that you can connect an external monitor.
2. Connect a keyboard and mouse to the oscilloscope.
3. Connect an external monitor to the upper SVGA port on the side panel of the oscilloscope.
4. Connect the oscilloscope power cord to the power source, and power on the oscilloscope and the external monitor.

5. The oscilloscope should detect that the new monitor is connected. Follow the instructions on the oscilloscope screen to install new drivers for the monitor.
6. Type **Ctrl+M** or select **Minimize** from the File menu to minimize the oscilloscope application.
7. On the Windows desktop, right click the mouse, and select **Properties** to open the Display Properties dialog box.
8. Select the **Settings** tab.
9. Right click on the disabled monitor in the display box, and select **Attached**. (Monitor 2 is attached to the instrument display; Monitor 1 is the disabled monitor.)
10. Set the resolution that you want to use on the external monitor (24 bit or better).
11. Click on the external monitor in the display box, and drag the external monitor to the correct orientation.



CAUTION. Do not change the resolution settings for the internal LCD monitor. The internal resolution must be 640 x 480. The colors should be set to either High Color (16 bit) or True Color (24 bit) with 24 bit color the preferred setting. (The external monitor should be set equal or better). If you use other settings, the video port may not work properly.

12. Select **Apply**.
13. Select **Yes** to restart your computer. The new monitor will display additional desktop area.

Using Dual Display

To make the best use of the new display area, do these additional steps to move the Windows controls to the external monitor:

1. Click (and hold) on the Windows task bar in the area shown in Figure 1-3, and then drag it upwards and toward the external monitor. The task bar will first go to the side of the internal monitor, then to the side of the external monitor, and finally to the bottom of the external monitor.

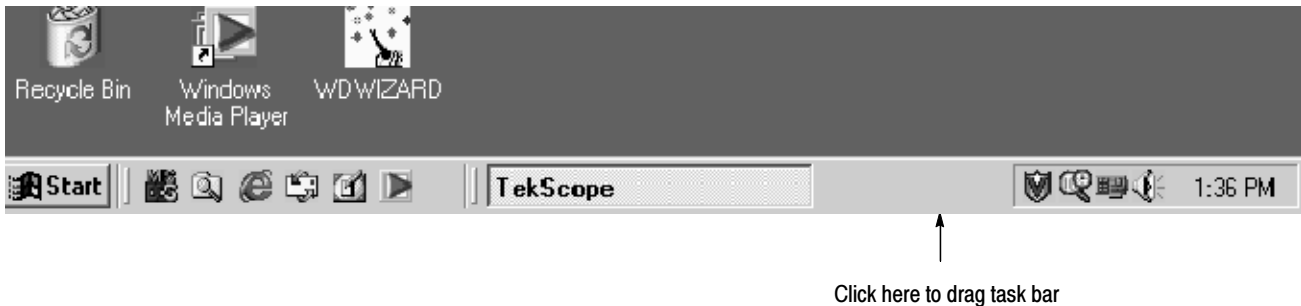

Figure 1-3: Drag area for Windows task bar

2. Release the mouse when the task bar is where you want it to be.
3. Select all the Windows desktop icons on the internal monitor, and drag the icons to a position on the external monitor.
4. If you use the oscilloscope online help system, you can drag the help windows to the external monitor so that you can read them while you operate the oscilloscope.
5. When you open any Windows application, drag the windows from the application to the external monitor.

Disabling an External Monitor

To disable the external monitor, do these steps:

1. Right click on the Windows desktop, and select **Properties** to open the Display Properties dialog box.
2. Click the **Settings** tab in the Display Properties dialog box.
3. Right click the external monitor
4. Deselect Attached (or Enabled) in the pop-up menu. You can also deselect *Extend my Windows desktop onto this monitor* at the bottom of the dialog box on the external monitor.

Adjusting Display Contrast

If you find that the oscilloscope screen is too bright or too dark, use these steps to adjust the LCD display contrast to your preference. You need to have a mouse attached to perform this procedure.

Windows ME If your instrument is using Windows ME, do the following steps:

1. Right click with the mouse on the Windows desktop.
2. Select **Properties**.
3. Select the **Settings** tab.
4. Click **Advanced**.
5. Select the **Chips** tab.
6. Click **Gamma**.
7. Adjust slider control for desired contrast.
8. Right click on the slider, and select **Exit**.

Windows 2000 If your instrument is using Windows 2000, do the following steps:

1. Right click with the mouse on the Windows desktop.
2. Select **Properties**.
3. Select the **Settings** tab.
4. Click **Advanced**.
5. Select the **Color** tab.
6. Adjust slider control for desired gamma setting.
7. Click **Apply**.
8. Click **OK**.

Incoming Inspection

This section contains instructions for performing the incoming inspection procedure. This procedure verifies that the oscilloscope is operating correctly after shipment, but does not check product specifications. This procedure contains the following parts:

- *Self Tests* on page 1-20 provides instructions for performing the internal self tests.
- *Functional Tests* on page 1-21 measures the time- and amplitude-reference signals at the PROBE COMPENSATION connector.
- *Perform the Extended Diagnostics* on page 1-30 provides instructions for performing internal self calibration and the extended diagnostics.

If the oscilloscope fails any test within this section, it may need service. To contact Tektronix for service, see *Contacting Tektronix* on page xv of *Preface*.

Make sure you have put the oscilloscope into service as detailed in *Installation* starting on page 1-5. Then assemble the following test equipment before proceeding with the tests.

Assemble Equipment

Self tests do not require any test equipment. The functional tests require:

- One passive 10X oscilloscope probe (P5050 or equivalent)
- One 1.44 MB, 3.5 inch, formatted floppy disk

Self Tests

This procedure uses internal routines to verify that the oscilloscope functions and was adjusted properly. No test equipment or hookups are required.

Equipment required	None
Prerequisites	Power on the oscilloscope and allow a 20 minute warm-up.

1. *Internal Diagnostics:* Perform these substeps to verify internal diagnostics.
 - a. *Display the system diagnostics menu:*
 - If the oscilloscope is in toolbar mode, click **Menu** (far right toolbar button) to switch to menu bar mode.
 - From the Utilities menu, select **Instrument Diagnostics** to open the Instrument Diagnostics control window.
 - Ensure that ALL is selected from each drop-down list.
 - b. *Run the system diagnostics:*
 - Disconnect any input signals from all four channels.
 - Click **Run** in the Instrument Diagnostics control window.
 - c. *Wait:* The internal diagnostics do an exhaustive verification of proper oscilloscope function, taking five to fifteen minutes. When complete, the resulting status appears in the diagnostics control window.
 - d. *Verify that no failures are found and reported:* All tests should pass. If any failures occur, record the failure information and contact your local Tektronix service personnel for more information.
 - e. *Run the signal path compensation routine:*
 - From the Utilities menu, select **Instrument Calibration** to open the Instrument Calibration control window.
 - Click **Calibrate** to start the routine.
 - f. *Wait:* Signal path compensation may take up to ten minutes to run.
 - g. *Confirm signal path compensation returns passed status:* Verify that the word **Pass** appears in the Status text box.
2. *Return:* Click **Close** to exit the Instrument Calibration control window.

Functional Tests

The purpose of these procedures is to confirm that the oscilloscope functions properly. The following equipment is required:

- One passive 10X oscilloscope probe (P5050 or equivalent)
- A 3.5 inch, 1.44 MB, formatted floppy disk to check the file system

STOP. *These procedures verify that the oscilloscope features operate. They do not verify that they operate within limits. Therefore, when the instructions in these functional tests call for you to verify that a signal appears on screen “that is about five divisions in amplitude” or “has a period of about six horizontal divisions,” and so on, do not interpret the quantities given as limits.*

Do not make changes to the front-panel settings unless directed to by these procedures. Each verification procedure requires you to set the oscilloscope to certain default settings before verifying functions. If you make additional changes to these settings you may obtain invalid results. In this case, redo the procedure from step 1.

When you are instructed to push a front-panel button or screen button, the button may already be selected (its label is lighted). If this is the case, it is not necessary to push the button.

Equipment required	One passive 10X oscilloscope probe (P5050 or equivalent)
Prerequisites	None

1. *Initialize the oscilloscope:* Push the front-panel **DEFAULT SETUP** button.
2. *Hook up the signal source:* Connect the oscilloscope probe from the probe compensation terminal to the channel input that you want to test (beginning with CH 1) as shown in Figure 1-4.

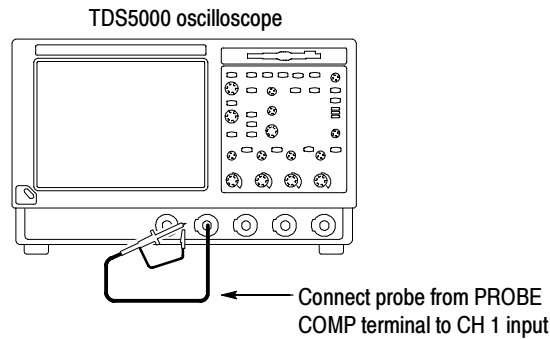

Figure 1-4: Universal test hookup for functional tests, CH 1 shown

3. *Turn off all channels:* If any of the front-panel channel buttons are lit, push those buttons to turn off the displayed channels. See Figure 1-5.

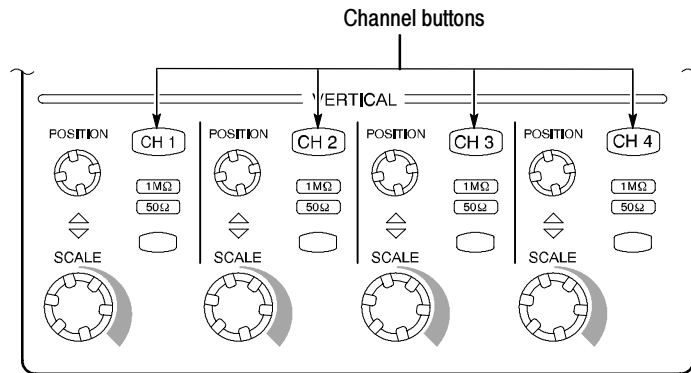

Figure 1-5: Channel button location

4. *Select the channel to test:* Push the channel button for the channel that you are currently testing. The button lights, and the channel display appears on the screen.

5. *Set up the oscilloscope:* Push the front-panel **AUTOSET** button. This sets the horizontal and vertical scale for a usable display and sets the trigger source to the channel you are testing.
6. *Verify that the channel is operational:* Confirm that the following statements are true.
 - The vertical scale readout (see Figure 1-6) for the channel under test shows a setting of 500 mV, and a square-wave probe compensation signal about 2 divisions in amplitude is on the screen.

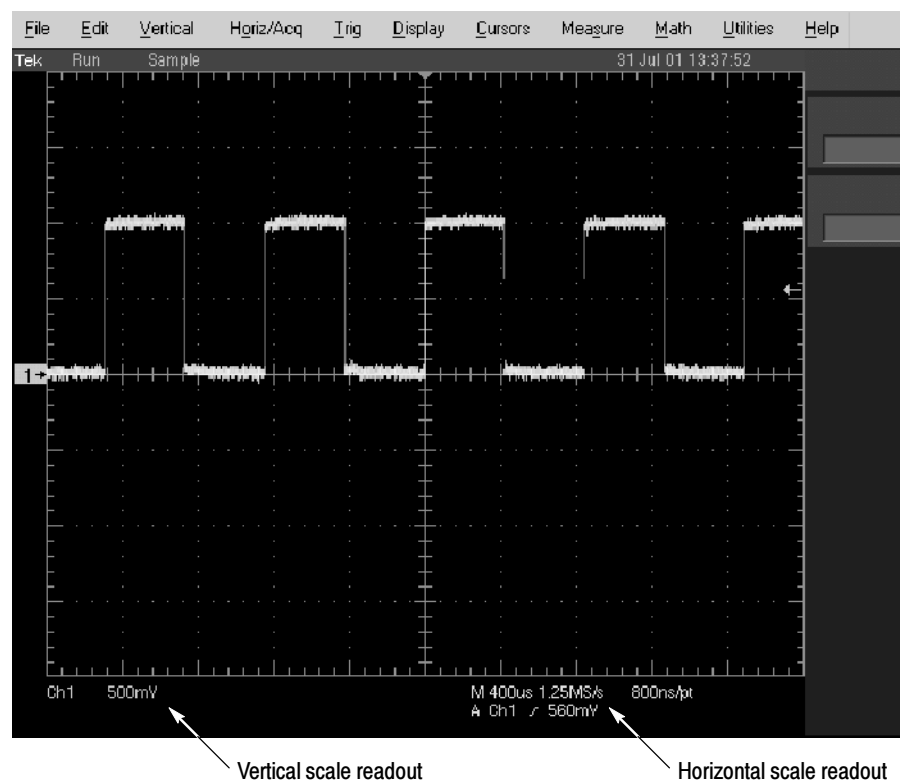

Figure 1-6: Location of vertical and horizontal scale readouts

- The front-panel **VERTICAL POSITION** knob for the channel that you are testing moves the signal up and down on the screen when rotated.
 - Turning the **VERTICAL SCALE** knob counterclockwise for the channel that you are testing decreases the amplitude of the waveform on the screen. Turning the knob clockwise increases the amplitude. Returning the knob to **500 mV** returns the amplitude to about 2 divisions.
7. *Verify that the channel acquires in all acquisition modes:* From the Horiz/Acq menu, select **Horizontal/Acquisition Setup** to open the

Horizontal/Acquisition Setup control window. Click the **Acquisition** tab. Click each of the five acquisition modes and confirm that the following statements are true:

- **Sample** mode displays an actively acquiring waveform on the screen. (Note that there is a small amount of noise present on the square wave).
 - **Peak Detect** mode displays an actively acquiring waveform with the high and low values (peaks) of consecutive sample intervals displayed. Therefore, the noise seen in Sample mode is visible here as well.
 - **Hi Res** mode displays an actively acquiring waveform with the noise that was seen in Sample mode reduced.
 - **Average** mode displays an actively acquiring waveform with the noise reduced using a multiple acquisition averaging technique.
 - **Envelope** mode displays an accumulation of multiple acquisitions using Peak Detect mode.
8. *Test all channels:* Repeat steps 2 through 7 until all four input channels are verified.
 9. *Remove the test hookup:* Disconnect the oscilloscope probe from the channel input and the probe compensation terminal.

Time Base Test

Equipment required	One passive 10X oscilloscope probe (P5050 or equivalent)
Prerequisites	None

1. *Initialize the oscilloscope:* Push the front-panel **DEFAULT SETUP** button.
2. *Hook up the signal source:* Connect the oscilloscope probe from the probe compensation terminal to the CH 1 input as shown in Figure 1-7.

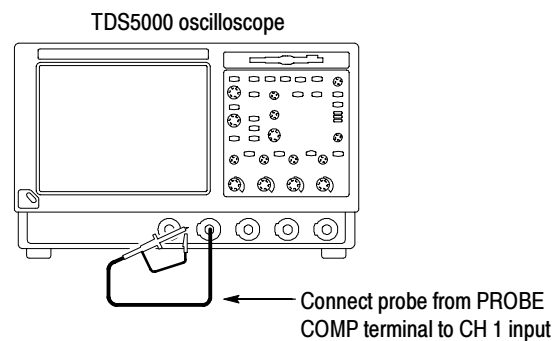

Figure 1-7: Setup for time base test

3. *Set up the oscilloscope:* Push the front-panel **AUTOSET** button.
4. *Set the time base:* Use the front-panel **HORIZONTAL SCALE** knob to set the horizontal scale to **200 $\mu\text{s}/\text{div}$** . The time-base readout is displayed at the bottom of the graticule (see Figure 1-6).
5. *Verify that the time base operates:* Confirm the following statements:
 - One period of the square-wave probe-compensation signal is about five horizontal divisions on the screen for the 200 $\mu\text{s}/\text{div}$ horizontal scale setting.
 - Rotating the **SCALE** knob clockwise expands the waveform (more horizontal divisions per waveform period), counterclockwise rotation contracts it, and returning to **200 $\mu\text{s}/\text{div}$** returns the period to about five divisions.
 - The **HORIZONTAL POSITION** knob positions the signal left and right on the screen when rotated.

6. *Verify horizontal delay:*
 - a. *Center a rising edge on screen:*
 - Turn the **HORIZONTAL POSITION** knob so that the rising edge where the waveform is triggered is lined up with the center horizontal graticule.
 - Change the **HORIZONTAL SCALE** to **20 $\mu\text{s}/\text{div}$** . The rising edge of the waveform should remain near the center graticule, and the falling edge should be off screen.
 - b. *Turn on and set horizontal delay:*
 - From the Horiz/Acq menu, select **Horizontal/Acquisition Setup** to open the Horizontal/Acquisition Setup control window.
 - Click the **Horizontal** tab in the control window that displays.
 - On the Horizontal tab, click **Delay Mode** to toggle delay mode On.
 - Click on the **Horiz Delay** control text box to display the pop-up keypad. Click the keypad icon to open the keypad. Use the keypad to set the horizontal delay to **500 μs** , and click **ENTER**.
 - c. *Verify the waveform:* Verify that a falling edge of the waveform is within a few divisions of the center graticule.
 - d. *Adjust the horizontal delay:* Rotate the upper multipurpose knob to change the horizontal delay setting. Verify that the falling edge shifts horizontally. Rotate the front-panel **HORIZONTAL POSITION** knob. Verify that this knob has the same effect (it also adjusts delay, but only when delay mode is on).
 - e. *Verify the delay toggle function:*
 - Rotate the front-panel **HORIZONTAL POSITION** knob to center the falling edge horizontally on the screen.
 - Change the **HORIZONTAL SCALE** to **40 ns/div** . The falling edge of the waveform should remain near the center graticule. If not, readjust the delay setting to center the falling edge.
 - Push the front-panel **DELAY** button several times to toggle the delay off and on and back off again. Verify that the display switches quickly between two different points in time (the rising and falling edges of the signal).
7. *Remove the test hookup:* Disconnect the probe from the channel input and the probe compensation terminal.

Trigger Test

Equipment required	One passive 10X oscilloscope probe (P5050 or equivalent)
Prerequisites	None

1. *Initialize the oscilloscope:* Push the front-panel **DEFAULT SETUP** button.
2. *Hook up the signal source:* Connect the oscilloscope probe from the probe compensation terminal to the CH 1 input as shown in Figure 1-8.

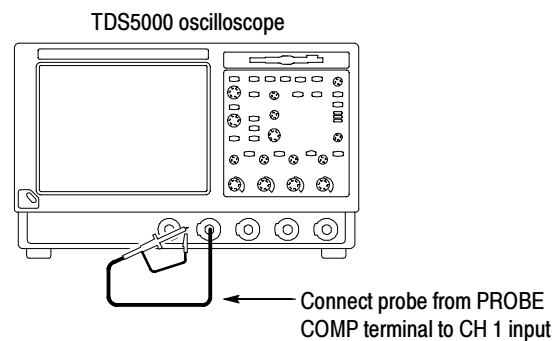

Figure 1-8: Setup for trigger test

3. *Set up the oscilloscope:* Push the front-panel **AUTOSET** button.
4. *Verify that the main trigger system operates:* Confirm that the following statements are true.
 - The trigger level readout for the A (main) trigger system changes with the front-panel **TRIGGER LEVEL** knob.
 - The front-panel **TRIGGER LEVEL** knob can trigger and untrigger the square-wave signal as you rotate it. (Leave the signal untriggered).
 - Pushing the front-panel **TRIGGER LEVEL** knob sets the trigger level to the 50% amplitude point of the signal and triggers the signal that you just left untriggered. (Leave the signal triggered.)

5. *Verify that the delayed trigger system operates:*
 - a. *Set up the delayed trigger:*
 - From the Trig menu, select **A-B Trigger Seq** to open the Trigger Setup control window. The window opens to the A→B Seq tab.
 - Click **Trig After Time** under A Then B.
 - Click in the **B Trig Level** text box on the far right of the control window.
 - b. *Confirm that the following statements are true:*
 - The readout in B Trig Level changes as you turn the lower multipurpose knob.
 - As you rotate the lower multipurpose knob, the square wave probe compensation signal can become triggered and untriggered. (Leave the signal triggered.)
 - c. *Verify the delayed trigger counter:*
 - Click on the **Trig Delay** control text box to display the pop-up keypad. Click the keypad icon to open the keypad.
 - Click on the keypad to enter a trigger delay time of 1 second, and click **Enter**.
 - Verify that the TRIGGER **READY** indicator on the front panel flashes about once every second as the waveform is updated on the screen.
6. *Remove the test hookup:* Disconnect the cable from the channel input and the probe compensation terminal.

File System Test

Equipment required	One passive 10X oscilloscope probe (P5050 or equivalent) One 3.5 inch, 1.44 MB, formatted floppy disk
Prerequisites	None

1. *Initialize the oscilloscope:* Push the front-panel **DEFAULT SETUP** button.
2. *Hook up the signal source:* Connect the oscilloscope probe from the probe compensation terminal to the CH 1 input as shown in Figure 1-9.

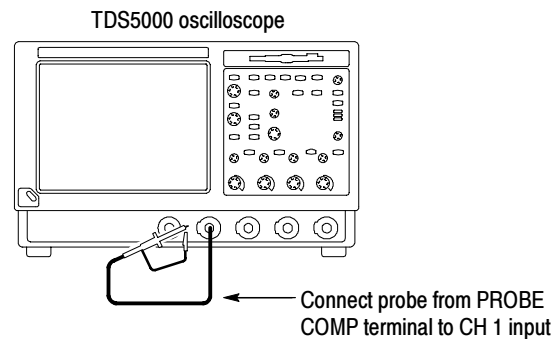

Figure 1-9: Setup for the file system test

3. *Insert the test disk:* Insert the floppy disk in the floppy disk drive at the top of the front panel.
4. *Set up the oscilloscope:* Push the front-panel **AUTOSET** button.
5. *Set the time base:* Set the **HORIZONTAL SCALE** to **1 ms/div**. The time base readout is displayed at the bottom of the graticule.
6. *Save the settings:*
 - a. Select the File menu **Instrument Setup** command. This opens the Instrument Setup control window.
 - b. Click the **Save** button under Save Settings to File. The Save Instrument Setup As dialog box opens.
 - c. From the Save in: drop-down list, select the **3¹/₂ Floppy (A:)** icon to set the save destination to the floppy disk.
 - d. Note the default file name, and click **Save** to save the setup to the default file name.
7. *Change the settings again:* Set the **HORIZONTAL SCALE** to **200 μs/div**.

8. *Verify the file system works:*
 - a. Click the **Recall Setups** tab in the control window.
 - b. Click **Recall** under Recall Settings from File. The Recall Instrument Setup dialog box opens.
 - c. From the Look in: drop-down list, select the **3¹/₂ Floppy (A:)** icon.
 - d. Locate and double-click on the setup file that you previously stored.
 - e. Verify that the oscilloscope retrieved the saved setup from the disk. Do this by noticing that the horizontal **SCALE** is again 1 ms and that the waveform shows ten cycles, just as it did when you saved the setup.

9. *Remove the test hookup:*
 - a. Disconnect the probe from the channel input and the probe compensation terminal.
 - b. Remove the floppy disk from the floppy disk drive.

Perform the Extended Diagnostics

Extended diagnostics and self calibration perform a more detailed functionality check than the incoming inspection and power-on diagnostics

NOTE. *Allow a 20 minute warm-up before running the self calibration.*

Disconnect any attached probes from the oscilloscope. Select the Utilities menu **Instrument Calibration** command to run the self-calibration and the **Instrument Diagnostics** command to run the extended diagnostics. Results of the tests display on the respective control windows.

Accessories and Options

This section lists the product options, product upgrades, standard accessories, and optional accessories that are available for the oscilloscope.

Options

You can order the options shown in Table 1-3 with the oscilloscope.

Table 1-3: Instrument options

Hardware options	
16	CD-RW drive (replaces CD-ROM drive)
17	Additional 256 MB of PC RAM
18	Touch-screen interface
1P	Built-in thermal printer
Acquisition memory options	
1M	2M/1M/500k on 1/2/4 channels (2M/1M on 1/2 channels on TDS5052)
2M	8M/4M/2M on 1/2/4 channels (8M/4M on 1/2 channels on TDS5052)
Mounting options	
1K	K420 oscilloscope cart with mouse accessory tray
1R	Rackmount kit
Software options	
2A	Advanced analysis—equation editor, spectral FFT, and histograms
DVD	TDSDVD—Optical storage analysis software
J1	TDSJIT2—Jitter & timing analysis software
J2	TDSDDM2—Disk drive measurements software
JT3	TDSJIT3—Jitter & timing analysis with Rj/Dj and BER estimation
PWR	TDSPWR2—Power analysis software
USB	TDSUSBS—USB2.0 compliance test software only
Probe options	
33	Add (1) P6158 3.0 GHz, 20x low capacitance probe
34	Add (1) P6247 1.0 GHz differential probe

Table 1-3: Instrument options (Cont.)

Probe options	
35	Add (1) P6243 1.0 GHz active probe
37	Add (1) P6245 1.5 GHz active probe
39	Add (1) P6248 1.7 GHz differential probe
53	Add (1) P5050 500 MHz, 10x passive probe
Power cord options	
A1	Universal European power cord (220 V, 50 Hz)
A2	UK power cord (240 V, 50 Hz)
A3	Australia power cord (240 V, 50 Hz)
A5	Switzerland power cord (220 V, 50 Hz)
AC	China power cord (240 V, 50 Hz)
A99	No power cord
Service options	
D1	Calibration data report
C3	Additional 2 years of calibration
D3	Calibration data report for Option C3
R3	Additional 2 years of repair
C5	Additional 4 years of calibration
D5	Calibration data report for Option C5
R6	Additional 4 years of repair

You can order the upgrade kits shown in Table 1-4 to extend the performance of your instrument after its initial purchase. Contact your local Tektronix representative for details and the most current information.

Table 1-4: Instrument upgrades

TDS5UP upgrade*	Description
Option 16	CD-RW drive (replaces CD-ROM drive)
Option 18	Touch-screen interface
Option MU	256 MB of PC RAM
Option M01	Upgrade acquisition memory depth from standard to option 1M
Option M02	Upgrade acquisition memory depth from standard to option 2M
Option M12	Upgrade acquisition memory depth from option 1M to option 2M
Option 1P	Built-in thermal printer

Table 1-4: Instrument upgrades (Cont.)

TDS5UP upgrade*	Description
Option W2K	Windows 2000 Professional Edition (contact your local Tektronix representative for details)
Option CPU	Upgrade to current motherboard and processor (contact your local Tektronix representative for details)
Option 2A	Advanced analysis—equation editor, spectral FFT, and histograms
Option DVD	TDSDVD—Optical storage analysis software
Option J1	TDSJIT2—Jitter & timing analysis software
Option J2	TDSDDM2—Disk drive measurements software
Option J23	TDSJIT2—TDSJIT3 upgrade
Option JT3	TDSJIT3—Jitter & timing analysis with Rj/Dj and BER estimation
Option PWR	TDSPWR2—Power analysis software
Option USB	TDSUSBS—USB2.0 compliance test software only
Option IF	Service installation of selected options

***When ordering a TDS5Up upgrade kit, you must order at least one option.**

Accessories

This section lists the standard and optional accessories available for this oscilloscope.

Standard The accessories shown in Table 1-5 are shipped with the oscilloscope.

Table 1-5: Standard accessories

Accessory	Part number
<i>TDS5000 Series Graphical Packing List</i>	071-1003-xx
<i>TDS5000 Series Digital Phosphor Oscilloscopes User Manual</i>	071-0876-xx

Table 1-5: Standard accessories (cont.)

Accessory	Part number
<i>TDS5000 Series Digital Phosphor Oscilloscopes Reference</i> English French German Italian Spanish Portuguese Japanese Korean Simplified Chinese Traditional Chinese	020-2398-xx
<i>Oscilloscope Analysis and Connectivity Made Easy</i> manual with software	020-2449-xx
<i>TDS5000 Series Product Software</i> CD-ROM (includes application, online help, <i>TDS5000 Series Online Programmer Guide</i> (GPIB online help and PDF), Performance Verification PDF, release notes, VISA information)	063-3508-xx
<i>TDS5000 Series Operating System Restore</i> CD-ROM	063-3509-xx
<i>Optional Applications Software for Tektronix Windows-Based TDS Instruments</i> CD-ROM and manuals	020-2450-xx
Calibration Certificate documenting NIST traceability, Z540-1 compliance, and ISO9001 registration	---
U.S. power cord	161-0230-xx
Mouse	119-6298-00
Front cover	200-4651-00
Two (TDS5052) or four (TDS5054) 500 MHz 10x passive probes	P5050

Optional

The accessories in Table 1-6 are orderable for use with the oscilloscope at the time this manual was published. Consult a current Tektronix catalog for additions, changes, and details.

Table 1-6: Optional accessories

Accessory	Part number
<i>TDS5000 Series Digital Phosphor Oscilloscopes Service Manual</i>	071-1004-xx
USB keyboard	119-6297-xx
K420 scope cart with mouse accessory Tray	K420, 436-0317-xx
Transit case	016-1522-xx

Table 1-6: Optional accessories (cont.)

Accessory	Part number
Thermal printer (including five rolls of paper)	655-4920-xx
Thermal printer paper (one roll)	016-1897-xx
TDS5000 Series rackmount Kit	016-1887-xx
Probe calibration, compensation, and deskew adapter (requires a separate pulse generator)	067-0405-00
Video display clamp	013-0278-00
P5050 500 MHz 10x passive probe	P5050
P6158 20x low-capacitance probe	P6158
P6247 1 GHz differential probe	P6247
P6243 1 GHz high speed active probe	P6243
P6245 1.5 GHz high speed active probe	P6245
P6248 1.7 GHz differential probe	P6248
P6246 400 MHz differential probe	P6246
TCP202 current probe	TCP202
CT-6 current probe	CT-6
AM503S DC/AC current measurement system	AM503S
AMT75 1 GHz 75 Ω adapter	AMT75
P5205 high voltage differential probe	P5205
P5210 high voltage differential probe	P5210
P5100 high voltage probe	P5100
P6105A high voltage probe	P6105A
AD400A differential preamplifier	AD400A
P6701B optical/electrical converter (multimode)	P6701B
P6703B optical/electrical converter (single mode)	P6703B
Stylus	016-1441-00
Click 'n Burn software (packaged with Option 16 CD-RW drive)	065-3575-xx
TDSJIT2 jitter and timing analysis software	TDSJIT2
TDSJIT3 jitter and timing analysis software with Rj/Dj and BER	TDSJIT3
TDSDDM2 disk drive measurement software	TDSDDM2
TDSUSB2 USB2.0 compliance test package	TDSUSB2
TDSUSBS USB2.0 compliance test software only	TDSUSBS
TDSUSBF USB2.0 compliance test fixture only	TDSUSBF

Table 1-6: Optional accessories (cont.)

Accessory	Part number
WSTRO WaveStar software; remote instrument control and waveform data acquisition	WSTRO
TDSPWR2 power measurement software	TDSPWR2
TDSDVD optical storage analysis software	TDSDVD
Wavewriter AWG and waveform creation software	S3FT400
Vocallink voice control software	VCLNKP
GPIB cable (3.3 ft, or 1 m)	012-0991-01
GPIB cable (6.6 ft, or 2 m)	012-0991-00
RS-232 cable	012-1298-00
Centronics cable	012-1250-00

Operational Maps

This chapter consists of several maps that describe the oscilloscope system, its operation, and documentation:





- *Documentation Map*, on page 2-2, lists the documentation that supports the oscilloscope.
- *Front Panel I/O Map*, on page 2-3, describes input/output ports and peripherals.
- *Front Panel Map*, on page 2-4, describes the elements of the oscilloscope front panel and cross references information relevant to each element.
- *User Interface Map*, on page 2-5, describes the elements of the User Interface (UI) application, which provides complete control of the oscilloscope.
- *Display Map*, on page 2-6, describes elements and operation of single-graticule and multiple-graticule displays.
- *System Overview Maps*, on page 2-8, describe the high-level operating blocks and operating cycle of the oscilloscope.

Tutorial procedures are available online, as part of the online help.

For information on configuring and installing your oscilloscope, refer to Chapter 1, *Getting Started*.

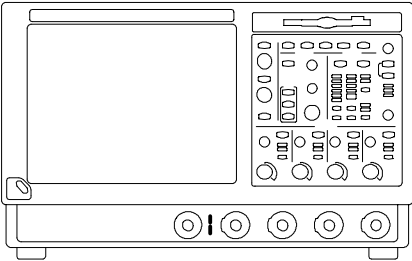
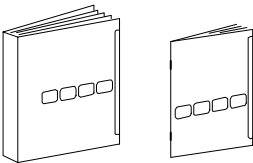
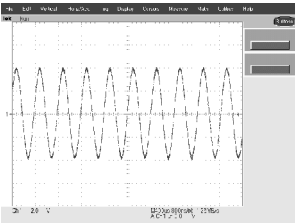
Documentation Map

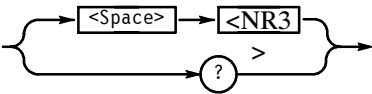
This oscilloscope ships with documents individually tailored to address specific parts of the product features and interface. The table below cross references each document to the oscilloscope features and interfaces it supports.

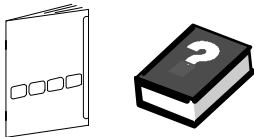
To read about...	Refer to these documents:	Description
<p>Installation, Specifications, & Operation (overviews)</p> 	<p>User Manual Reference</p> 	<p>Read the <i>Reference</i> for a quick overview of oscilloscope features and their usage.</p> <p>Read the <i>User Manual</i> for general information about your oscilloscope: procedures on how to put it into service, specifications of its performance, maps of its user interface controls, overviews and background on its features.</p> <p>For more usage information, see <i>Online Help System</i>, below.</p>
<p>In Depth Operation and UI Help</p> 	<p>Online Help System</p> 	<p>Access online help from the oscilloscope UI for information on virtually all controls and elements on screen.</p> <p>Online help includes instructions for using oscilloscope functions. See <i>Accessing Online Help</i> on page 3-209.</p>
<p>GPIB Commands</p> 	<p>Programmer Online Guide</p> 	<p>Quickly remind yourself of the syntax of a command, and copy the command if desired. Read about communication, error handling, and other information on GPIB usage. This guide is on the product software CD.</p>
<p>Analysis and Connectivity Tools</p>	<p>Oscilloscope Analysis and Connectivity Made Easy</p> <p>TekVISA Programming Manual</p> 	<p>TekVISA consists of various connectivity and analysis tools that you can install and configure for your oscilloscope. For more information, see the <i>Analysis and Connectivity Support</i> topic in the instrument online help.</p>

You may also want to obtain the optional service manual for this product if you do self-service or performance verifications on this oscilloscope. See *Accessories and Options* on page 1-31.

Front Panel I/O Map

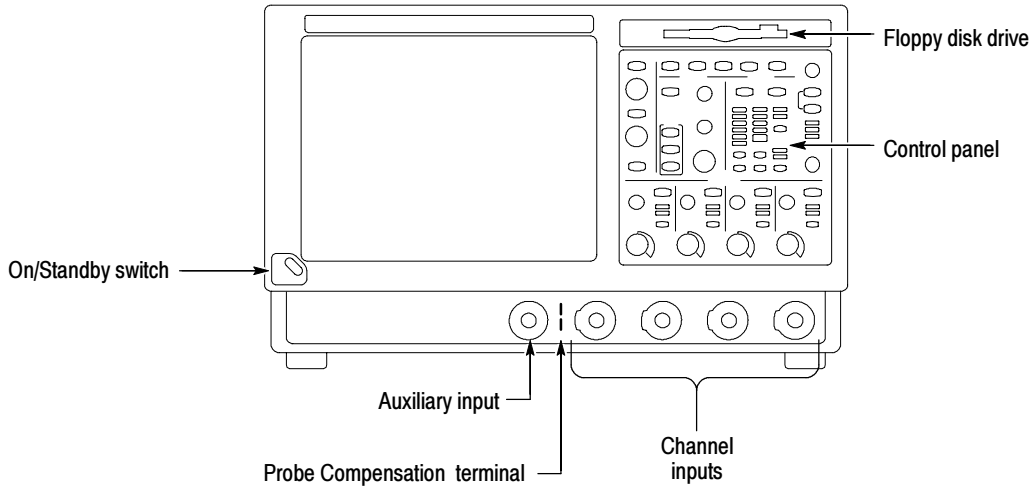

Control Panel Map: Quick Access to Most Often Used Features

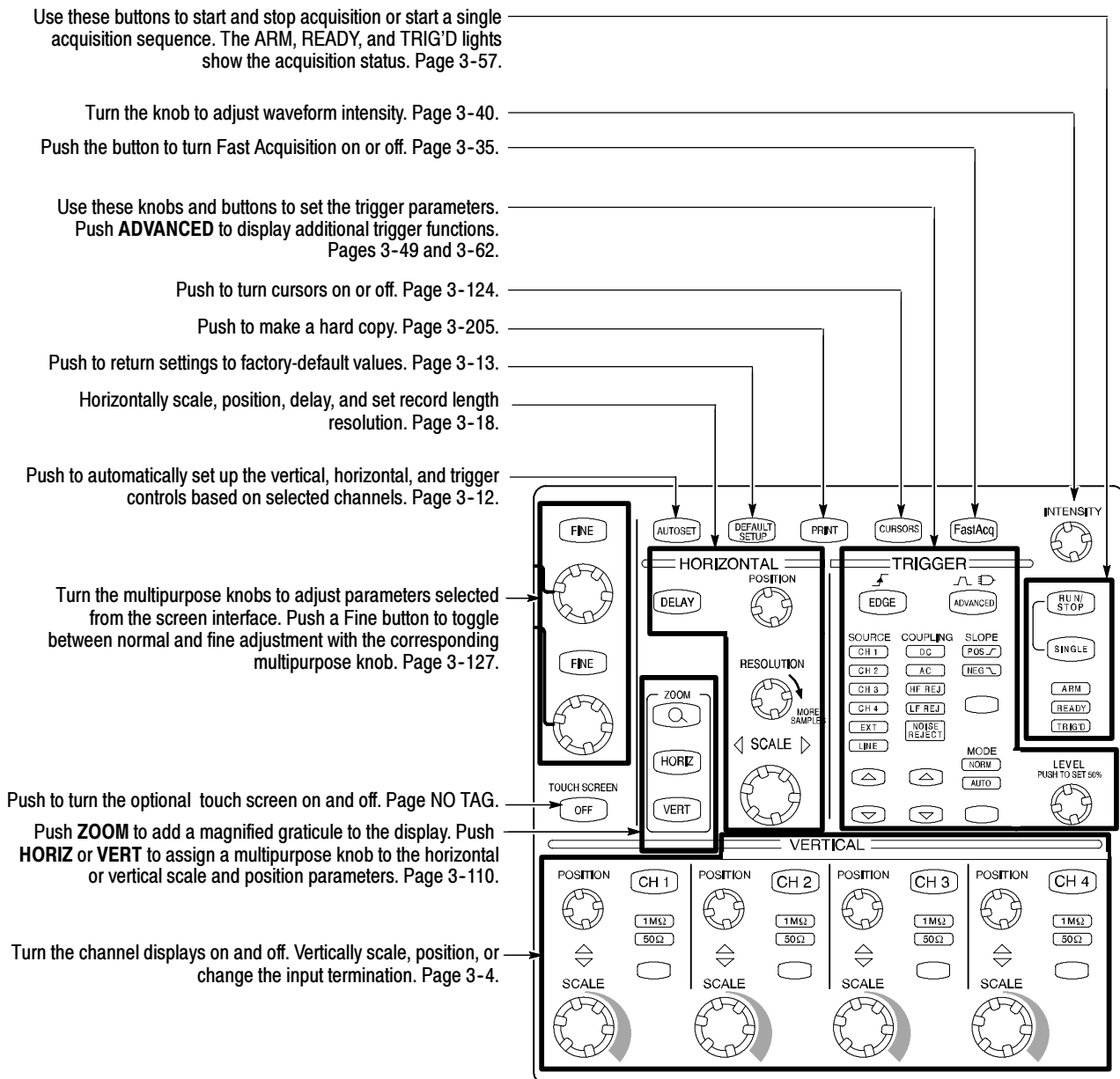

User Interface Map - Complete Control and Display

Menu Bar: Access to data I/O, printing, online help system, and oscilloscope functions

Status Bar: Display of acquisition status, mode, and number of acquisitions; trigger status; date; and time

Display: Live, reference, and math waveforms display here, along with cursors

Waveform Handle: Touch and drag to change vertical position of waveform. Touch the handle and change the position and scale using the multipurpose knobs

Controls Status: Quick reference to vertical, horizontal, and trigger selections, scale, and parameters

Buttons/Menu. Touch to toggle between toolbar and menu bar modes

Multipurpose Knob Readouts. Adjust parameters controlled by multipurpose knobs

Readouts: Display cursor readouts and measurement readouts in this area; selectable from the menu bar or tool bar

If a control menu is displayed, these readouts move to the graticule area

Display Map - Single Graticule

Drag icon to change the trigger level

Drag cursors to measure waveforms on screen

Drag the position icons to reposition a waveform

Click the icon to assign the multipurpose knobs to waveform vertical position and scale

Drag across the waveform area to create a box for zooming, enabling/disabling histograms, and gating measurements

Ch1 5.0V 1040.00s 12.5MS/s 0.0s 80.0ns A Ch1 -660m V

Menu

Curs1 Pos
-113.6us

Curs2 Pos
99.2us

T1: -113.6us
T2: 99.2us
ΔT: 212.8us
1/ΔT: 4.599KHz

Zoom
Histogram
Measurement Gating
Zoom Off
Histogram Off
Measurement Gating Off
Cancel

Side and Rear Panel I/O & Connectors Map

Left Side

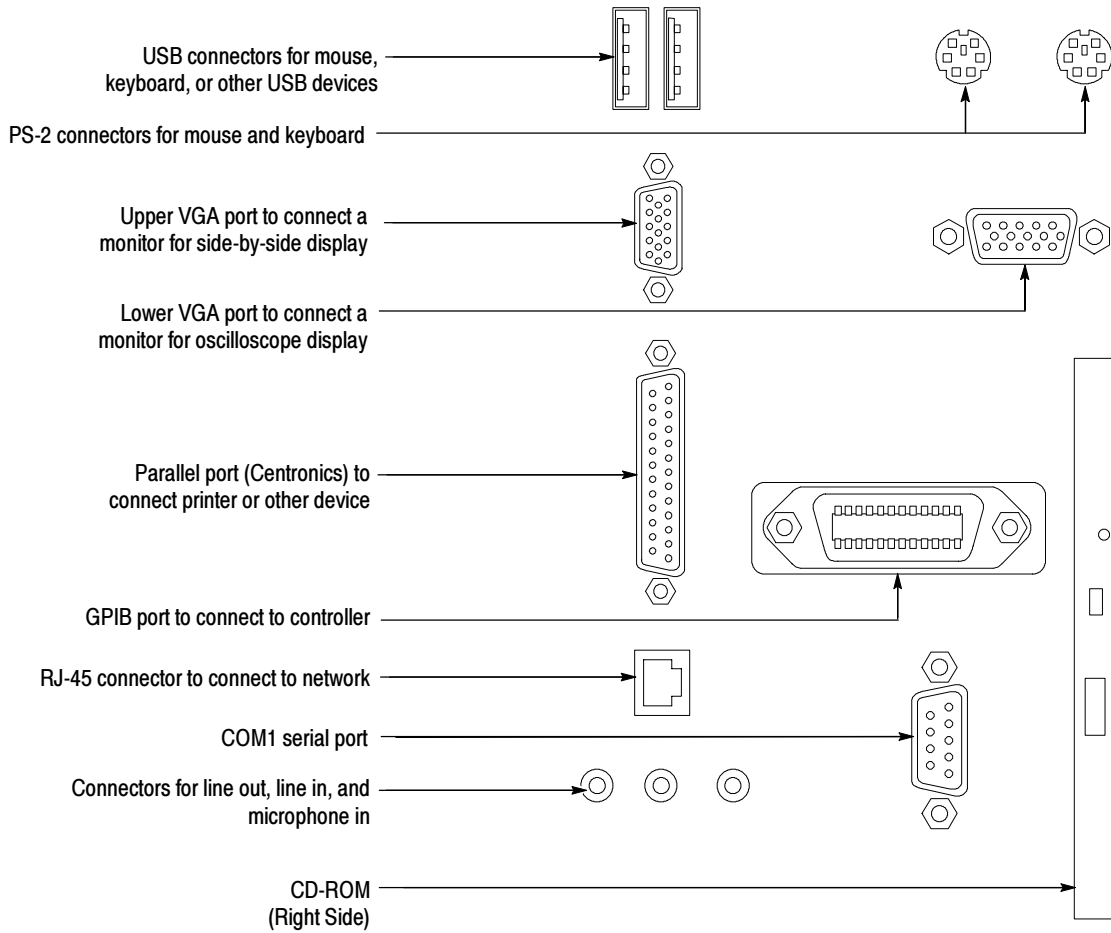

Rear

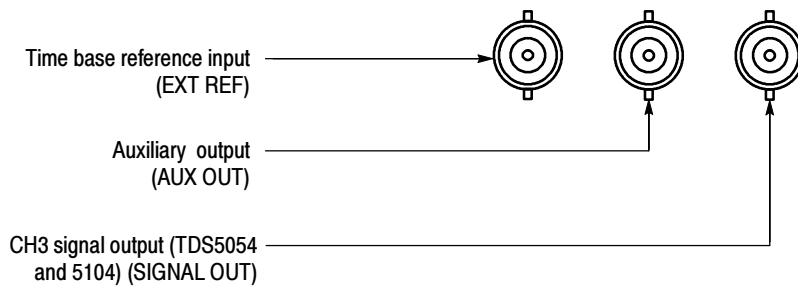

System Overview Maps

The following sections provide a high-level description of how the oscilloscope acquires, processes, and outputs signal information.

Functional Model Map

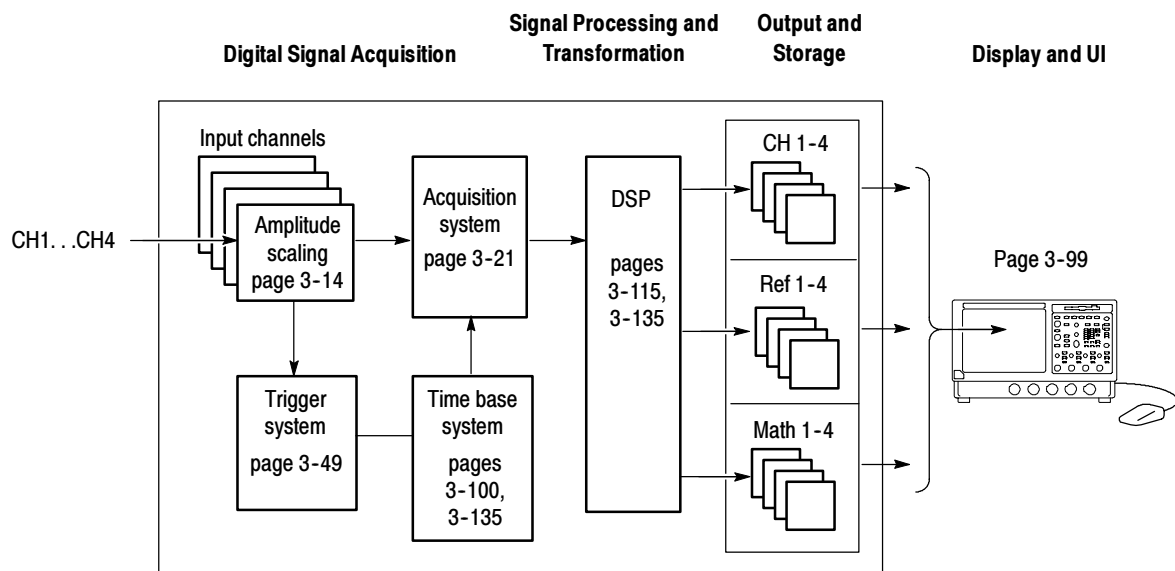

The oscilloscope has four high-level subsystems or processes (consisting of both hardware and software functions) and the “data” that connects them:

- **Digital Signal Acquisition System.** Acquires a waveform record from each signal you probe using the following subsystems:
 - **Input Channels.** Conditions the input signal, primarily through the use of analog hardware, before converting the signal to digital form.
 - **Trigger System.** Recognizes a specific event of interest on the input signal and informs the Time base system of the occurrence of the trigger event.

- **Time base System.** Triggers the Acquisition system to start an acquisition cycle. In more general terms, synchronizes the capturing of digital samples in the Acquisition system to the trigger events generated from the Trigger system.
- **Acquisition System.** Converts and stores the analog signal to a digital format.
- **Signal Processing and Transformation.** Performs transformations or operations on user-specified waveform data (channel, reference, and/or math waveforms). Automatic measurements, spectral waveforms, and histogram generation are examples of signal processing and transformation.
- **Display and UI.** Provides output (and sometimes input) of oscilloscope-data elements in a form suitable to the user and also provides user input control.

The process overview that follows describes each step in the top-level cycle of oscilloscope operation.

Process Overview Map

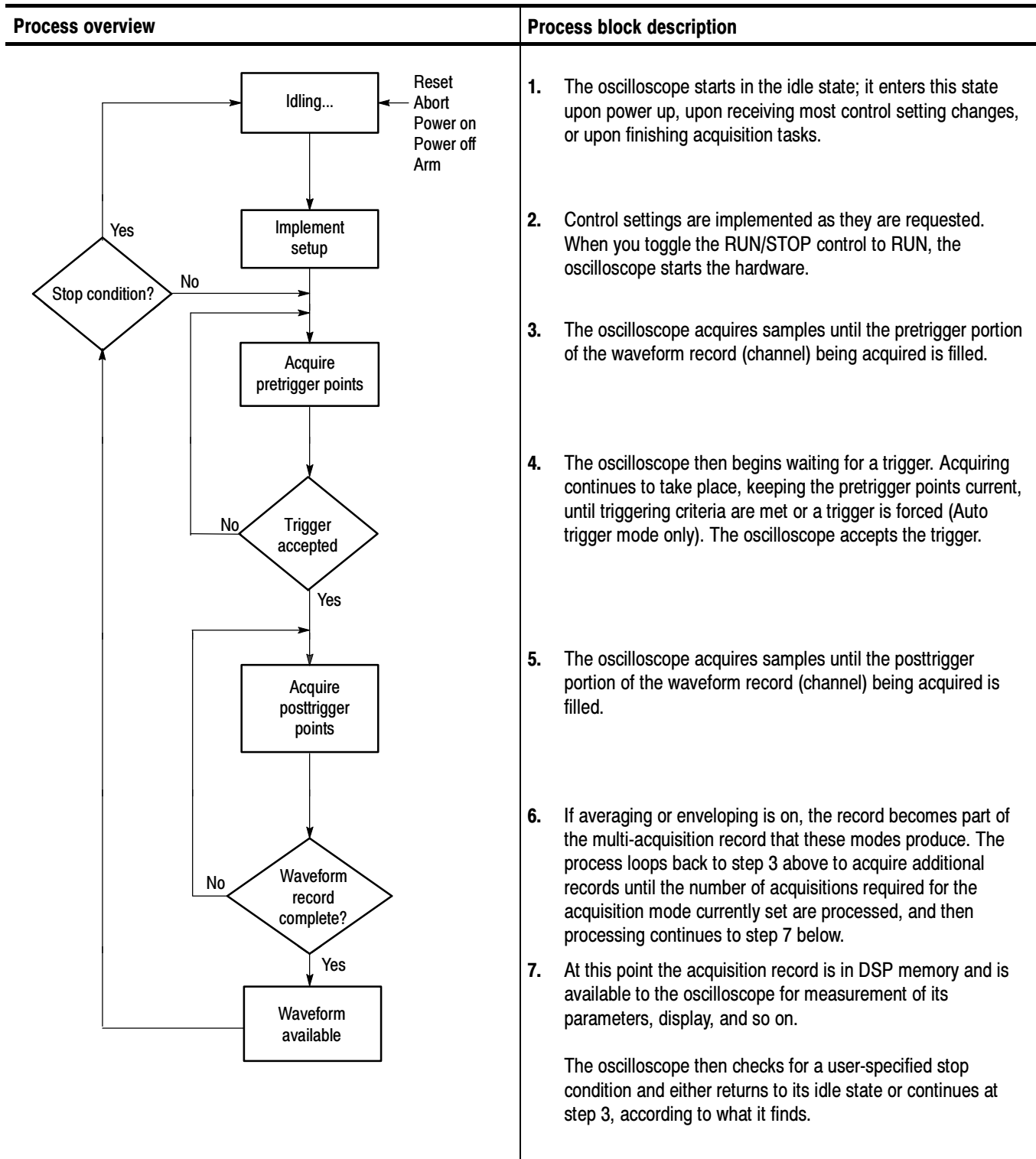

Overview

This chapter provides a detailed description of the TDS5000 Series Digital Phosphor Oscilloscopes features. Please note the following when using this chapter:

- Each section provides the background information needed to operate your oscilloscope effectively, as well as the higher-level procedures for accessing and using the features.
- These procedures emphasize using the front panel when possible.
- Lower-level, detailed usage procedures are in the online help system.

The following table lists operating tasks and the sections in this chapter that document those tasks.

Tasks or topics	Subtasks or subtopics	Section title	Contents	Page no.
Signal Input	Acquiring waveforms	<i>Acquiring Waveforms</i>	Overview of section contents	3-3
		<i>Signal Connection and Conditioning</i>	Overview of signal connection and conditioning techniques and setups	3-4
		<i>Autosetting the Oscilloscope</i>	Automatic setup of the acquisition, triggering systems, and input channels	3-12
		<i>Input Conditioning Background</i>	Background information on input signal conditioning	3-14
		<i>Setting Acquisition Controls</i>	Setup of acquisition controls and roll mode	3-21
		<i>Setting Acquisition Modes</i>	Set up of the acquisition system	3-25
		<i>Acquisition Control Background</i>	Background information on acquisition controls	3-29
		<i>Using Fast Acquisitions Mode</i>	Overview and setup of Fast Acquisitions mode	3-35
		<i>Using FastFrame</i>	Overview and set up of FastFrame	3-42
Signal Input	Triggering waveforms	<i>Triggering</i>	Background on basic trigger operation	3-49
		<i>Triggering From the Front Panel</i>	Using the front-panel edge trigger controls	3-54
		<i>Advanced Triggering</i>	Overview and setup for triggering on specific pulse and logic conditions	3-62
		<i>Sequential Triggering</i>	Overview and setup for triggering after time delay and triggering on events	3-91

Tasks or topics	Subtasks or subtopics	Section title	Contents	Page no.
Display Features	Using the Display	<i>Displaying Waveforms</i>	Using display features and customizing the display	3-99
		<i>Using the Waveform Display</i>	Overview of display features and setup of the display	3-100
		<i>Customizing the Waveform Display</i>	Customizing the display	3-106
		<i>Using the Zoom Feature</i>	Overview and use of Zoom	3-110
Data Processing (Calculation)	Taking Measurements	<i>Measuring Waveforms</i>	Setup to make measurements	3-115
		<i>Taking Automatic Measurements</i>	Overview and setup for taking automatic measurements	3-115
		<i>Taking Cursor Measurements</i>	Overview and setup for taking cursor measurements	3-124
		<i>Taking Histograms (Optional)</i>	Overview and setup for taking Histograms	3-130
	Math (+, -, /, *, Intg, Diff, Average, Invert, Sqrt, Log 10, Log e, Exp, Magnitude, Real, Phase, and Imag)	<i>Creating and Using Math Waveforms</i>	Functions for processing waveforms, extracting segments of waveforms, etc.	3-135
Spectral Math operations	<i>Defining Spectral Math Waveforms</i>	Functions for frequency domain analysis of your waveforms.	3-151	
Data Input and Output	All uploading and downloading of waveforms, calculation results, and other data	<i>Data Input/Output</i>	Primary reference for uploading and downloading of any data to or from the oscilloscope	3-183
		<i>Saving and Recalling Setups</i>	Background and setup for saving and recalling setups	3-183
		<i>Saving and Recalling Waveforms</i>	Background and setup for saving and recalling waveforms	3-189
		<i>Clearing References</i>	Setup to clear references	3-194
		<i>Exporting and Copying Waveform Data</i>	Background and setup for exporting waveforms and using exported waveforms	3-196
		<i>Printing Waveforms</i>	Background and setup for printing waveforms	3-205
		<i>Using the Date/Time Stamp</i>	Background and setup to display the date and time	3-207
Remote Communication	GPIB	<i>Remote Communication</i>	Information on programming the oscilloscope over the GPIB	3-207
Help	Using Online Help	<i>Accessing Online Help</i>	Information on accessing the information in the online help	3-209

Acquiring Waveforms

Before you can process a waveform, you must acquire the signal. This oscilloscope comes equipped with the features you need for capturing your waveforms before further processing them according to your requirements. The following sections cover capturing signals and digitizing them into waveform records:

- *Signal Connection and Conditioning:* Connecting waveforms to the oscilloscope channels; scaling and positioning the channels and time base for acquiring waveforms.
- *Setting Acquisition Controls:* Choosing the appropriate acquisition mode for acquiring waveforms; starting and stopping acquisition.
- *Acquisition Control Background:* Background information on the data sampling and acquisition process.
- *Using Fast Acquisition Mode:* Using Fast Acquisition mode to capture and display transient events, such as glitches or runt pulses, which are often missed during the long dead times that are a normal part of digital oscilloscope (DSO) operation.
- *Using FastFrame:* Using FastFrame to capture many records in a larger record, and then view and measure each record individually.

Figure 3-1 shows how this process fits into the overall oscilloscope operation.

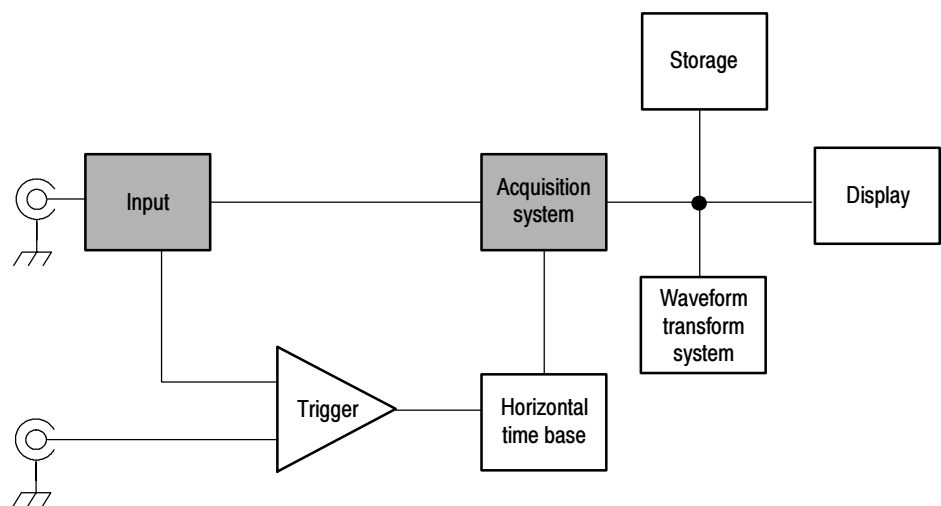

Figure 3-1: Oscilloscope System Overview: Signal Acquisition

NOTE. This section describes how the vertical and horizontal controls define the acquisition of live waveforms. These controls also define how live and derived waveforms (math waveforms, reference waveforms, and so on) are displayed. Information on waveform display is found in:

- Displaying Waveforms on page 3-99.
 - Creating and Using Math Waveforms on page 3-135.
-

Signal Connection and Conditioning

This section reviews the oscilloscope features related to setting up the input signal for digitizing and acquisition. It addresses:

- Turning on channels and adjusting vertical scale, position, and offset.
- Setting horizontal scale and position, and accessing record length and trigger position controls.
- Getting a basic trigger on your waveform.

NOTE. Terminology: This manual uses the terms vertical acquisition window and horizontal acquisition window. These terms refer to the vertical and horizontal range of the segment of the input signal that the acquisition system acquires. The terms do not refer to any display windows on screen.

Figure 3-2 shows the model for each input channel.

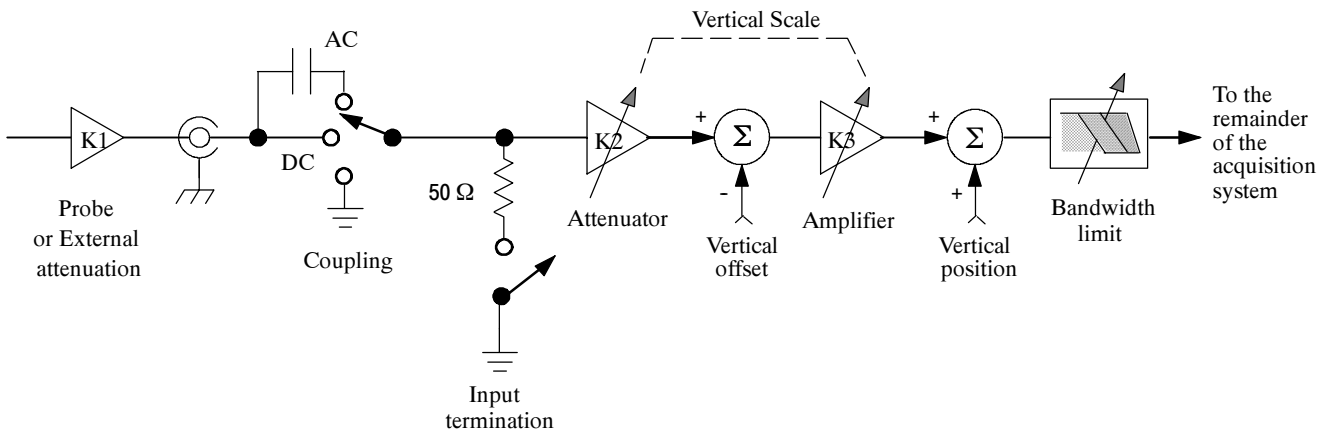

Figure 3-2: Input and Acquisition Systems and Controls

Use input conditioning to ensure that the oscilloscope acquires the best possible data for processing. To do this:

- Set the vertical scale to control the size of the vertical acquisition window for each channel to capture all or part of the input signal vertical amplitude. When vertical scaling is set to capture a fraction of the input signal (to increase detail), the vertical offset control determines which part of the input signal is captured by the vertical acquisition window.
- Set the horizontal scale to control the size of the horizontal acquisition window to capture as much as you want of the input signal(s). Set the horizontal position to delay the window relative to a trigger and to control where in the input signal (data stream) that the horizontal acquisition window acquires.

For more background on acquisition windows, refer to *Input Conditioning Background* on page 3-14.

The oscilloscope can automatically obtain and display a stable waveform of usable size. Push the AUTOSSET button to automatically set the oscilloscope controls based on the characteristics of the input signal. Autoset is much faster and easier than a manual control-by-control setup.

The oscilloscope can also be reset to its factory default settings by pushing the front-panel DEFAULT SETUP button.

Use of some input conditioning controls or features may be limited when other control settings are in effect. Voltage offset is incompatible with reference waveforms because offset is an acquisition control.

Connecting and Conditioning Your Signals

The following sections provide details that can make it easier to set up and acquire your waveforms.

Probes and Signal Connection. Select the probe or cable that brings the signal into the oscilloscope. Choose the probe or cable that best fits your acquisition task, whether it's connecting an active probe to test a digital circuit, or connecting to a test fixture through BNC cables to characterize a device. The connection to the oscilloscope depends on your application.

Tektronix provides a variety of probes and cables for this product. Refer to *Accessories and Options* on page 1-31 for a list of TDS5000-compatible probes. You can also check your Tektronix catalog for connection accessories to support your probing requirements. For more information about a particular probe, read the documentation that came with that probe.

Up to four acquisition channels are available. You can display each channel as a waveform and/or use the channel data to create other waveforms, such as math and reference waveforms.

Coupling. All oscilloscopes and probes specify a maximum signal level. (Exact limits for this instrument are provided in Appendix A, *Specifications*.) Do not exceed the limit, even momentarily, as the input channel may be damaged. Use external attenuators if necessary to prevent exceeding the limits.

Coupling determines whether an input signal is directly connected to the input channel (DC coupling), connected through a DC blocking capacitor (AC coupling), or not connected at all (GND coupling).

The input resistance of each input channel is 1 M Ω or 50 Ω . To properly terminate signals when using coaxial cables, or to support active probes designed for a 50 Ω environment, a 50 Ω termination resistance can be selected by pushing the front-panel termination button for a particular channel.

All probes expect a specific coupling and input termination. Both coupling and input termination resistance are displayed on the screen. If the oscilloscope determines the coupling and termination required by the probe, either implicitly because of the TEKPROBE interface or through performing a probe calibration, the oscilloscope sets the required coupling and input termination.

Consider the following when you use 50 Ω termination with any channel:

- The oscilloscope does not accurately display frequencies under 200 kHz if AC coupling is selected.
- The oscilloscope reduces the maximum volts per division setting for the channel to 1 V from 10 V (10 V from 100 V with a 10X probe attached), since input amplitudes appropriate for the higher settings would overload the 50 Ω input.
- The oscilloscope switches to 50 Ω termination and DC coupling if you connect an active probe. Active probes also reduce the maximum volts per division.

Scaling and Positioning. The scaling and positioning controls determine the portion of the input signal received by the acquisition system.

- Set vertical scaling, positioning, and DC offsets to display the features of interest on your waveform and to avoid clipping. (Refer to *Note* that follows.) *Vertical Acquisition Window Considerations* on page 3-14 describes the vertical acquisition window.

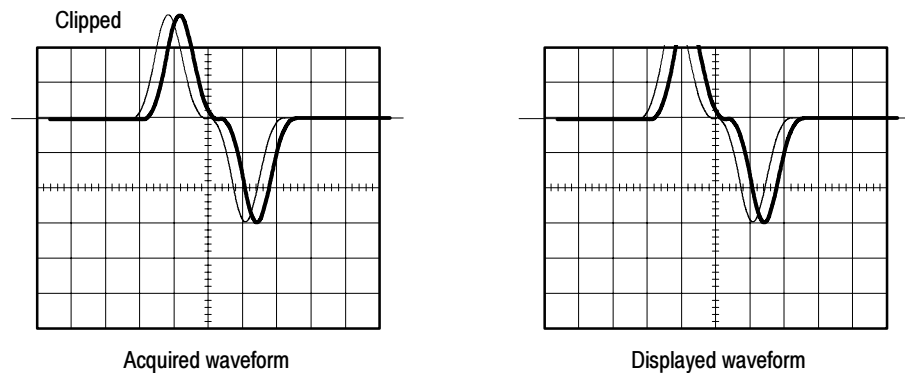

- Set horizontal scale, position, and resolution (record length) so that the acquired waveform record includes the waveform attributes of interest with good sampling density on the waveform. These settings define the horizontal acquisition window, described in *Horizontal Acquisition Window Considerations* on page 3-18.

NOTE. *Waveform data outside of the vertical acquisition window is clipped; that is, the data is limited to the minimum or maximum boundaries of the vertical acquisition window. This causes inaccuracies in amplitude-related measurements. Refer to Vertical Acquisition Window Considerations on page 3-14.*



Trigger and Display. Set basic trigger controls to gate waveform acquisition, and use the display to interactively scale, position, and offset waveforms. Refer to the sections *Triggering* on page 3-49 and *Displaying Waveforms* on page 3-99.

Flexible Control Access. This manual focuses on basic setup, first through the front panel, and then through use of the application user interface (UI).

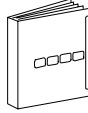
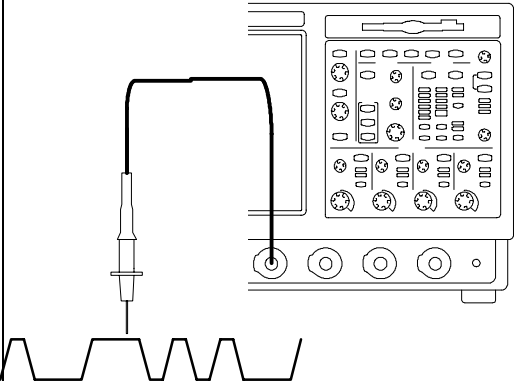
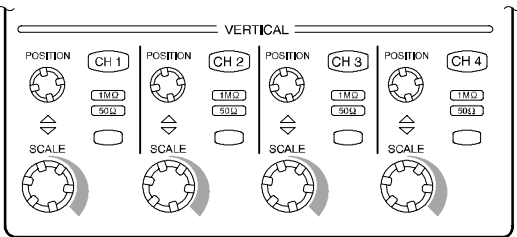
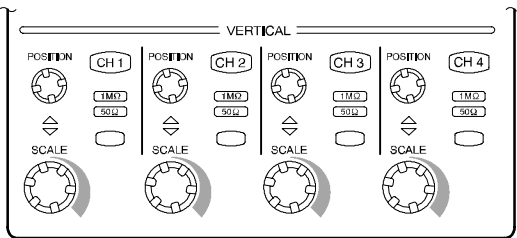

Setting Up Signal Input

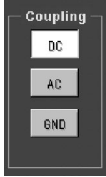
Use this procedure to set scale and position parameters for input signal acquisition. For more information, display online help while performing the procedure.

Overview	To set up signal input	Control elements and resources
<p>Prerequisites</p>	<p>1. The acquisition system should be set to run continuously.</p>	 <p>Refer to page 3-25 for acquisition setup and page 3-49 for trigger setup.</p>
<p>Connect input signal</p>	<p>2. Connect the probe to the input signal source using proper probing/connecting techniques.</p> <p>Note: For more details on input setup, access online help for the Vertical Setup control window.</p>	
<p>Select the input signal channel</p>	<p>3. Push a channel button (CH 1-CH 4) to select the input signal channel.</p> <p>A channel button lights when its channel is on.</p>	
<p>Select input termination</p>	<p>4. Push an input termination button to toggle between 1 MΩ and 50 Ω input termination.</p> <p>Hint: Some probes automatically set their termination value.</p>	

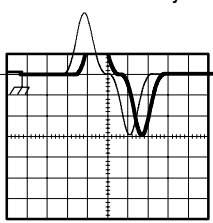
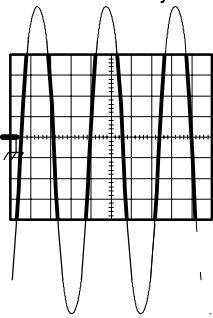
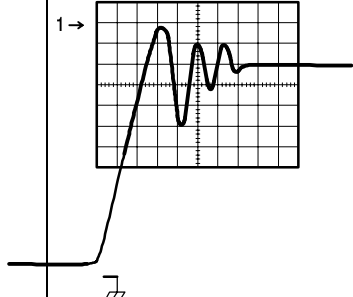
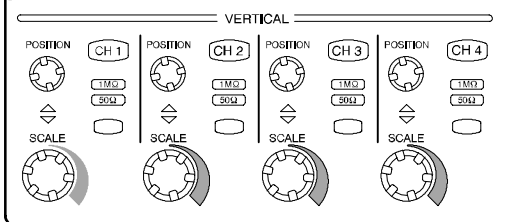
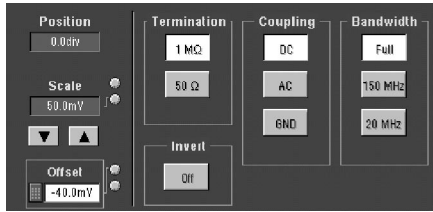
Overview	To set up signal input	Control elements and resources
<p>Select input coupling</p>	<p>5. Open the Vertical Setup control window by clicking Vert on the button bar or selecting the Vertical Setup command from the Vertical menu. To change the input coupling, select the appropriate channel tab and click:</p> <ul style="list-style-type: none"> ■ DC to couple both the AC and DC components of an input signal. ■ AC to couple only the AC components of an input signal. ■ GND to disconnect the input signal from the acquisition system. <p>Click Close to close the window.</p>	
<p>Invert the channel</p>	<p>6. Click Invert to toggle inversion of the selected waveform. When Invert is On, the selected waveform appears mathematically inverted (flipped) on the zero volt axis. No trace of the normal waveform is left on the screen.</p>	

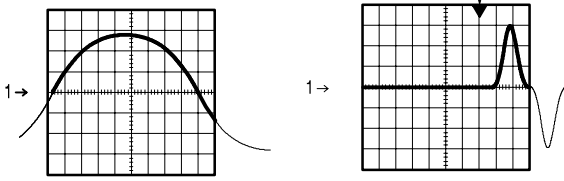
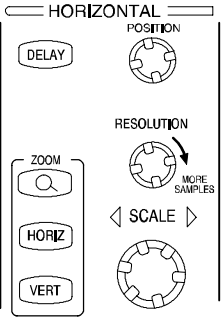

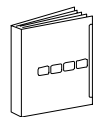
Overview	To set up signal input	Control elements and resources
<p>Set the vertical acquisition window</p>	<p>7. Use the vertical knobs to scale and position the waveform on screen.</p> <p>Positioned vertically</p>  <p>Scaled vertically</p>  <p>Dragging the waveform handle also positions the waveform.</p> <p>8. Open the Vertical Setup control window as described in Step 5. To change the offset, click the Offset control, and use the multipurpose knob to adjust the offset.</p> 	 

Overview	To set up signal input	Control elements and resources
<p>Set the horizontal acquisition window</p>	<p>9. Use horizontal knobs to scale and position the waveform on the screen and to set the record length.</p> <p>Dragging the reference icon also positions the waveform.</p>  <p>Scaled horizontally Positioned horizontally</p> <p>The Resolution knob sets the record length and sample interval. (Refer to the discussion on page 3-19.)</p> <p>If required to stabilize the display, push the trigger LEVEL control to set the trigger level to 50%.</p>	
<p>For help</p>	<p>10. For more information on the controls described in this procedure, access online help for the Vertical Setup and/or Horizontal/Acquisition Setup control window.</p>	
<p>Continue with acquisition setup</p>	<p>11. To finish acquisition setup, you must set the acquisition mode and start the acquisition.</p>	 <p>Refer to <i>Setting Acquisition Modes</i> on page 3-25.</p>

Autosetting the Oscilloscope

Autoset automatically sets up the oscilloscope controls (acquisition, display, horizontal, trigger, and vertical) based on the characteristics of the input signal. Autoset is much faster than manual control-by-control setup. When the input signal is connected, use Autoset to automatically set up the oscilloscope:

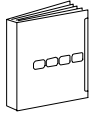
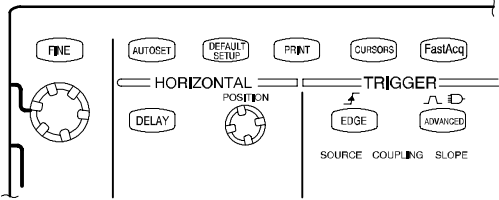
NOTE. Autoset may change vertical position to position the waveform appropriately. It always sets vertical offset to 0 V.

Overview	To Autoset the oscilloscope	Control elements and resources
<p>Prerequisites</p>	<p>1. Signals must be connected to channels. A triggering source must be provided.</p>	 <p>Refer to page 3-49 in this manual for trigger setup information.</p>
<p>Execute Autoset</p>	<p>2. Push the AUTOSSET button to execute an Autoset.</p> <p>If you use Autoset when one or more channels are displayed, the oscilloscope selects the lowest numbered channel for horizontal scaling and triggering. You can individually control the vertical scaling of each channel.</p> <p>If you use Autoset when no channels are displayed, the oscilloscope turns on channel one (CH 1) and scales it.</p>	
<p>Execute Autoset Undo</p>	<p>3. The Autoset Undo control window opens automatically after an Autoset operation. Click Undo if you want to undo the last Autoset.</p> <p>Only the parameters that were set by the last Autoset are undone. Parameters that you changed that are not controlled by Autoset retain their settings.</p>	

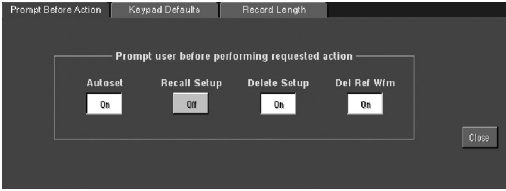
Overview	To Autoset the oscilloscope	Control elements and resources
<p>Display a prompt</p>	<p>4. Select User Preferences from the Utilities menu to display the Prompt Before Action window. Click Autoset to toggle between OFF and ON:</p> <ul style="list-style-type: none"> ■ OFF to immediately perform an Autoset when the AUTOSET button is pushed. ■ ON to display a prompt when the AUTOSET button is pushed. <p>Click Close to save your selection.</p>	

NOTE. The Autoset Undo control window remains on the screen until you open another control window. After Autoset Undo closes, you can still undo the last Autoset by selecting the Undo Last Autoset command from the Edit menu. Although the last Autoset is immediately undone, the Autoset Undo control window does not open again.

Resetting the Oscilloscope

Do the following to reset the oscilloscope to the factory default settings:

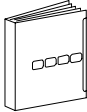
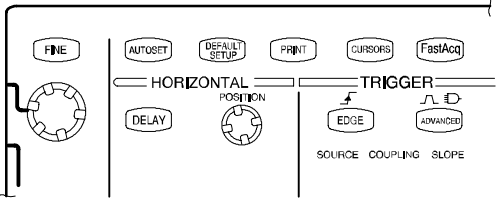
Overview	To reset the oscilloscope	Control elements & resources
<p>Prerequisites</p>	<p>1. The oscilloscope is powered up and running.</p>	 <p>Refer to <i>Powering On the Oscilloscope</i> on page 1-8.</p>
<p>Reset the oscilloscope</p>	<p>2. Push the DEFAULT SETUP button.</p>	

Input Conditioning Background

This section contains background information that can help you more effectively set up the acquisition window of each channel.

Input. Keep in mind that this oscilloscope samples in real time or random equivalent time; both sampling systems provide pretrigger information by using the trigger to stop an already running acquisition. Both sampling systems also sample the input after it is scaled, providing improved input protection and dynamic range.



CAUTION. *To prevent damage to the instrument, do not overdrive the inputs. Observe static-safe procedures.*

Autoset Considerations. Autoset acquires samples from the input signal and attempts to take the following actions based on the input data:

- Evaluate the amplitude range of the input signals and set the size and vertical offset of the vertical acquisition window to acquire the signal with good resolution, but without clipping.
- Set the trigger to the approximate midlevel of the signal being Autoset and switches to edge trigger mode.
- Evaluate the signal transitions and set the horizontal scale to produce a waveform display of 2 or 3 cycles of the input signal.

Sometimes Autoset cannot produce a correct display due to the nature of the input signal. If so, you may have to adjust the scale, trigger, and acquisition controls manually. Some conditions that can cause Autoset to fail are:

- No signal present
- Signals with extreme or variable duty cycles
- Signals with multiple or unstable signal periods
- Signals with too low amplitude
- No recognizable trigger signal
- Signals with a frequency < 20 Hz
- Signals with a frequency above the bandwidth of the oscilloscope

Vertical Acquisition Window Considerations. You can set the vertical size, position, and offset of each channel independently of other channels. Vertical scale and offset specify the vertical acquisition window for each channel. Parts of the signal amplitude that fall within the vertical window are acquired; parts outside (if any) are not.

The offset control subtracts a constant DC level from the input signal before the vertical scale factor is applied, and the vertical position control adds a constant number of divisions of signal after the scale factor is applied to the resulting difference.

The vertical scale and position controls have the following affects on the vertical acquisition window and the displayed waveform:

- The vertical volts per division you set determines the vertical size of the acquisition window, allowing you to scale it to contain all of a waveform amplitude or only part. Figure 3-3 on page 3-16 shows two vertical acquisition windows that contain the entire waveform, but only one window contains the entire waveform in the graticule on screen.

NOTE. *Amplitude-related automatic measurements (for example, peak-to-peak and RMS) will be accurate for vertical windows like those shown in Figures 3-3a and b because neither waveform is clipped (that is, both waveforms are acquired). But if signal amplitude were to extend outside the vertical acquisition window, the data acquired is clipped. Clipped data causes inaccurate results if used in amplitude-related automatic measurements. Clipping also causes inaccurate amplitude values in waveforms that are stored or exported for use in other programs.*

If the scale of a math waveform is changed so that the math waveform is clipped, it will not affect amplitude measurements on that math waveform.

- The vertical position adjusts the display of the graticule relative to the vertical acquisition window (position is a display control). Figure 3-3b shows how vertical position moves the waveform graticule vertically in the acquisition window to place the acquired waveform in the graticule display. That is all position does; it does not determine what data is acquired as do vertical scale and offset.

- a. **SCALE setting determines the vertical acquisition window size. This window is 100 mV/div x 20 divisions (10 graticule divisions and ± 5 divisions of position)**

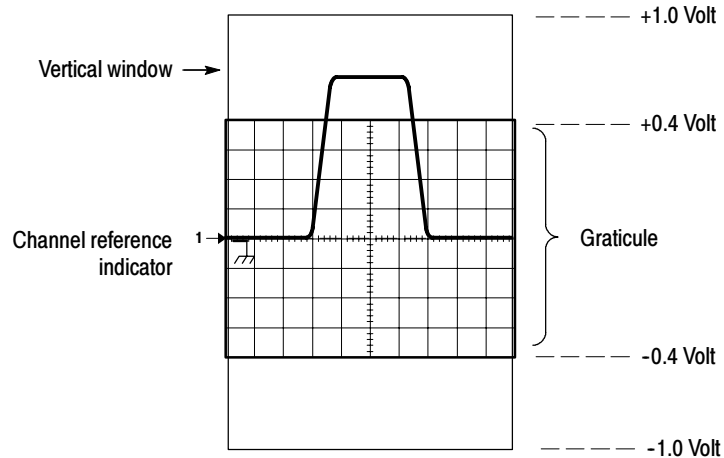

- b. **Vertical position can change the location of the display graticule within the acquisition window, repositioning it so that its waveform appears in the graticule**

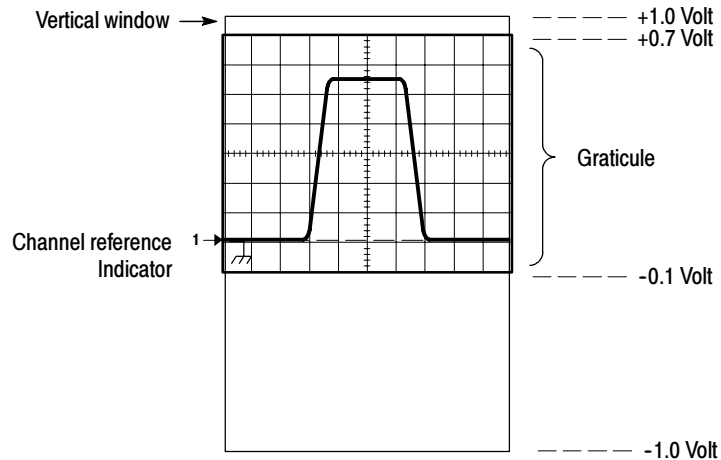

Figure 3-3: Setting vertical range and position of input channels

The vertical offset control affects the vertical acquisition window and the displayed waveform as follows:

- The vertical range (window) is always centered around the offset value. The range is the voltage level at the middle of the vertical acquisition window. With no (zero) offset, as shown in Figures 3-3 a and b, that voltage level is zero (ground).

- As you vary vertical offset, the middle voltage level moves relative to zero. This moves the vertical acquisition window up and down on the waveform. With input signals that are smaller than the window, it appears the waveform moves in the window. Actually, a larger signal shows what really happens: the offset moves the middle of the vertical acquisition window up and down on the input signal. Figure 3-4 shows how offset moves the acquisition window to control the portion of the waveform amplitude the window captures.
- Applying a negative offset set moves the vertical range down relative to the DC level of the input signal. Likewise, applying a positive offset moves the vertical range up. See Figure 3-4.

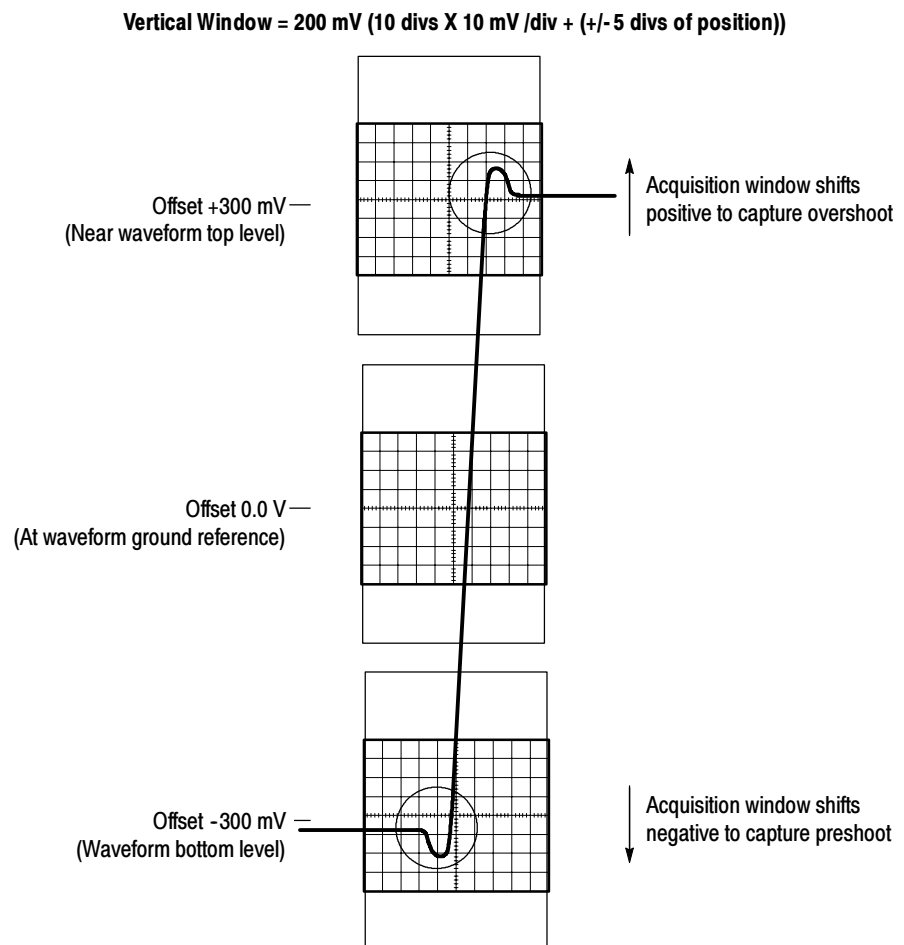

Figure 3-4: Varying offset moves the vertical acquisition window on the waveform

Horizontal Acquisition Window Considerations. The oscilloscope lets you define the horizontal acquisition window, that is, set several parameters that determine the segment of an incoming signal that becomes the waveform record when acquired. (For background, read *Waveform Record* on page 3-31.) These common parameters specify a horizontal acquisition window that is applied to all channels in parallel. (Refer to *Independent vs. Shared Window* on page 3-20.) These parameters, shown in Figure 3-5, are:

- *Trigger Condition:* Determines the point on the waveform that triggers the oscilloscope.
- *Horizontal Position:* Determines the number of pretrigger and posttrigger samples. samples before the trigger point are pretrigger samples and those after the trigger point are posttrigger samples.
- *Horizontal Delay:* Determines the time from the trigger point to the Horizontal Reference.
- *Horizontal Scale and Waveform Record Length (number of samples):* Determines the horizontal size of the window relative to any waveform, allowing you to scale it to contain a waveform edge, a cycle, or several cycles.

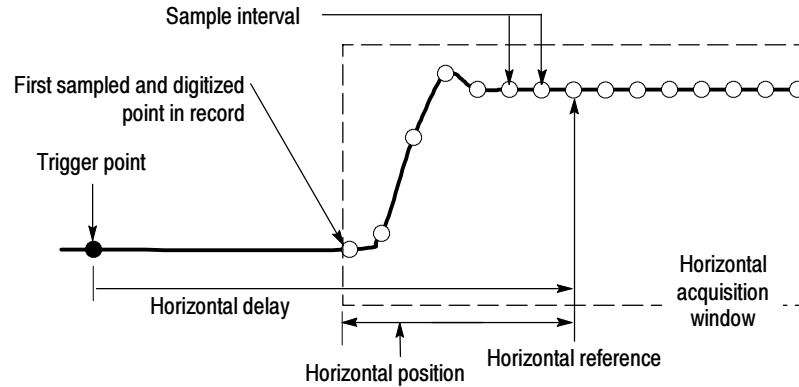

Figure 3-5: Horizontal acquisition window definition

Horizontal Scale vs. Record Length vs. Sample Interval vs. Resolution. These related parameters specify the horizontal acquisition window. Because the horizontal acquisition window must fit in the 10 horizontal division display, for most cases, you can set the Time Duration of the horizontal acquisition window (10 divs x the scale setting) as described below. By also setting a Record Length in samples, you indirectly set the Resolution, Sample Interval, and Sample Rate for the horizontal acquisition window (waveform record). The relationship between these horizontal elements is:

1. *Time Duration (seconds) = 10 divs (window size) x Horizontal Scale (sec/div)*
2. *Time Duration (seconds) = Sample Interval (seconds/sample) x Record Length (samples)*, where *Time Duration* is the horizontal acquisition window time duration, and

$$\text{Sample Interval (sec/sample)} = \text{Resolution (sec/sample)} = 1/\text{Sample Rate (samples/sec)}$$

Note that it is the Sample Interval that changes to accommodate the window Time Duration (and its scale setting) and the Record Length setting. These elements behave as follows:

- If the Record Length or Time Duration change, the Sample Interval will vary to accommodate the change. The Sample Interval can vary up to the highest Sample Rate, the lowest Sample Interval, and the highest Resolution.
- If the Sample Interval reaches its lower limit, the Record Length must decrease if the Time Duration decreases (you set faster scale settings), or Time Duration must increase (forcing slower scale settings) if Record Length increases (you set longer record lengths). The equation becomes:

$$\text{Maximum Record Length} = \text{Time Duration} \div \text{Min Sample Interval}$$

For example, at 200 ps/div and 10 divisions, the record length must be 500 points:

$$\text{Max Rec Length 500 samples} = (10 \text{ divs} \times 200 \text{ ps/div}) \div 4 \text{ ps/sample}$$

$$\text{Max Rec Length} = 500 \text{ samples}$$

NOTE. As implied from the operation just described, Resolution and the equivalent elements, Sample Interval and Sample Rate, are derived and cannot be set directly. You can, however, check the Resolution at anytime in the resolution readout. Also note that the front-panel RESOLUTION knob actually adjusts the Record Length to increase sample density.

The previous discussion also assumes that Horizontal Scale is held constant. You can hold the Sample Rate constant instead by clicking Hold Sample Rate constant on the Record Length tab of the User Preferences control window.

Independent vs. Shared Window. The oscilloscope applies the same horizontal acquisition window to all channels from which it acquires data. Unlike the vertical acquisition window that you size and offset independently for each channel, the same time/div, resolution (record length), and horizontal position (from the same trigger point) apply to all channels simultaneously. One trigger, from a single trigger source, will locate a common horizontal acquisition window for all active channels, which you can shift in parallel by setting the horizontal position control. See Figure 3-6.

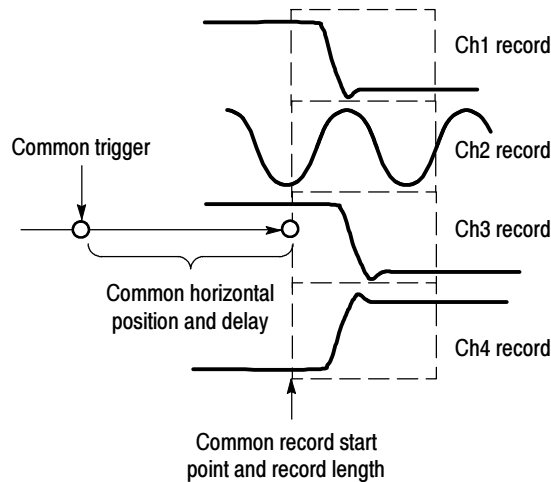

Figure 3-6: Common trigger, record length, and acquisition rate for all channels

Setting Acquisition Controls

This section reviews the features that start and stop data acquisitions and the features that control how the oscilloscope processes the data as it is acquired.

Acquisition Modes

The following acquisition modes are available:

- *Sample*: The oscilloscope does no postprocessing of acquired samples. The first sample from each *acquisition interval* is saved. An acquisition interval is the time covered by the waveform record divided by the record length. Sample mode is the default mode.
- *Peak Detect*: The oscilloscope alternates between saving the lowest sample in one acquisition interval and the highest sample in the next acquisition interval. This mode only works with real-time, noninterpolated sampling.
- *Hi Res*: The oscilloscope creates a record point by averaging all samples taken during an acquisition interval. Hi Res results in a higher-resolution, lower-bandwidth waveform. This mode only works with real-time, noninterpolated sampling.

A key advantage of Hi Res mode is its potential for increasing resolution regardless of the input signal. Table 3-1 indicates that you can obtain up to 15 significant bits with Hi Res mode. Note that the resolution improvements are limited to speeds slower than 40 ns/div.

Table 3-1: Additional resolution bits

Time base speed	Bits of resolution	Bandwidth
40 ns and faster	8 bits	> 550 MHz
80 ns to 200 ns	9 bits	> 110 MHz
400 ns to 1 μ s	10 bits	> 22 MHz
2 μ s to 4 μ s	11 bits	> 5.5 MHz
10 μ s to 20 μ s	12 bits	> 1.1 MHz
40 μ s	13 bits	> 550 kHz
100 μ s to 200 μ s	14 bits	> 110 kHz
1 μ s and slower	15 bits	< 55 kHz

- *Envelope*. As waveforms are acquired, the oscilloscope continually retains the running minimum (Min) and maximum (Max) values in adjacent sample intervals, creating an envelope of the number of waveforms you specify. Once the specified number of waveforms is reached, the data is cleared and the process starts over. This is similar to Peak Detect mode, except that Envelope mode gathers peaks over many trigger events.

- *Average*: The oscilloscope processes the number of waveforms you specify into the acquired waveform, creating a running average of the input signal. This mode reduces random noise.

Acquiring and displaying a noisy square wave signal illustrates the difference between the modes. Note how Average mode reduces the noise while Envelope mode captures its extremes:

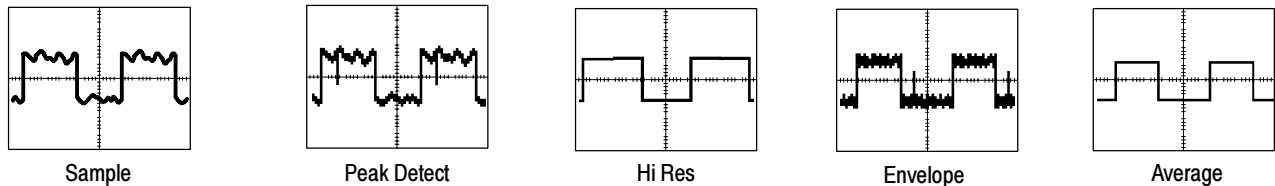

Controlling Acquisitions

You have two main options for controlling acquisitions. To access these options, use the front-panel buttons or select Run/Stop from the Horiz/Acq menu.

- *RUN/STOP button*: Click this button to set the oscilloscope to start and stop an acquisition only when you push the Run/Stop button in this window or RUN/STOP on the front panel. If toggled to Run, acquisition will start if a valid trigger occurs. If toggled to Stop, acquisition stops immediately. Single Sequence is not affected.
- *Single Sequence button*: Click this button (or press the SINGLE front-panel button) to set the oscilloscope to automatically stop acquisition when one complete acquisition sequence is completed. Refer to step 4, *Set the Stop mode*, on page 3-26 for more information.

Global Controls. Like the horizontal controls, the acquisition controls apply to all active channels; for example, channel 1 cannot acquire in Sample mode while channel 2 acquires in Envelope mode. You cannot stop channel 4 from acquiring (if turned on) while other channels continue to acquire.

Roll Mode

Roll mode gives a display similar to a strip chart recorder for low frequency signals. Roll mode lets you see acquired data points without waiting for the acquisition of a complete waveform record. For example, in normal acquisition mode, if the horizontal scale is 1 second per division, 10 seconds are required to fill the waveform record. Without roll mode you must wait 10 seconds before the waveform appears. With roll mode, you can see results almost immediately.

Untriggered Roll Mode. Untriggered roll mode displays newly acquired data points at the right edge of the waveform record while moving older waveform

data points to the left. To stop acquiring data, push the front-panel RUN/STOP button (see Figure 3-7).

Use untriggered roll mode to continuously observe a slow process. Apply math and measurement operations after you push RUN/STOP to stop the acquisition.

Untriggered Roll Mode with Single Sequence. Untriggered roll mode with single sequence displays newly acquired data points at the right edge of the waveform record while moving older waveform data points to the left. Acquisitions automatically stop after a complete waveform record is acquired (see Figure 3-7).

Use untriggered roll mode with single sequence to save data for later viewing. For example, at 20 seconds per division and 30 K record length, there are 12000 seconds of acquired data points.

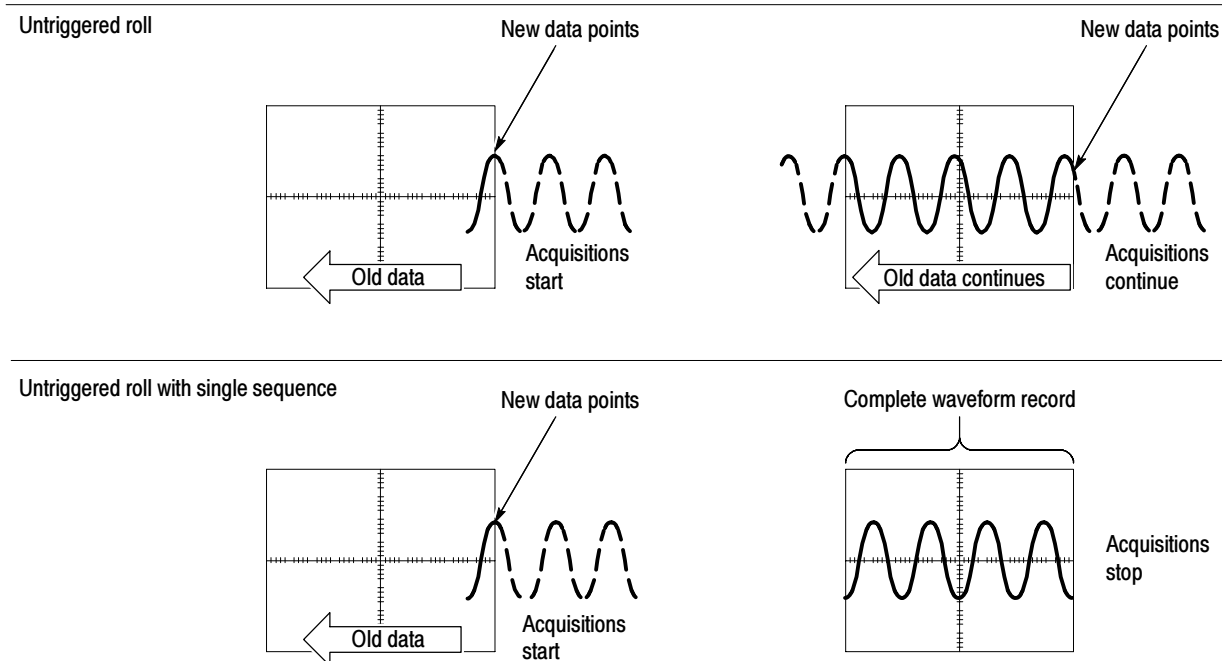

Figure 3-7: Roll modes

Preventing Aliasing

Under certain conditions, a waveform may be aliased. When a waveform is aliased, it appears on screen with a frequency lower than the actual waveform being input, or it appears unstable even though the TRIG'D control is lighted. Aliasing occurs because the oscilloscope is not sampling the signal often enough to construct an accurate waveform record. (See Figure 3-8.)

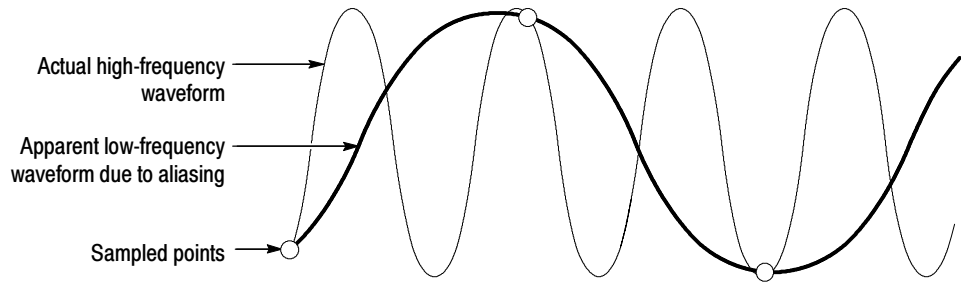

Figure 3-8: Aliasing

Eliminating Aliasing. To quickly check for aliasing, slowly increase the horizontal scale (time per division setting). If the shape of the displayed waveform changes drastically or becomes stable at a faster time base setting, your waveform was probably aliased.

To avoid aliasing, sample the input signal at a rate more than twice as fast as the highest frequency component. For example, a signal with frequency components of 500 MHz would need to be sampled at a rate faster than 1 Giga-samples/second to represent it accurately and to avoid aliasing. The following tips may help you eliminate aliasing on a signal:

- Adjust the horizontal scale.
- Push the AUTOSSET button.
- Switch the acquisition to Envelope mode. Envelope mode searches for samples with the highest and lowest values over multiple acquisitions and can detect faster signal components over time.

Incompatible Modes

The following table shows which acquisition features and modes are incompatible with other features or modes:



Incompatible with	Control/Feature	Explanation
Reference Waveforms (Ref1-Ref4)	Voltage Offset	Offset is an acquisition control not a display control
Single shot acquisition	Average	Acquisitions continue until the specified number of waveforms have been acquired and averaged

Incompatible with	Control/Feature	Explanation
Single shot acquisition	Envelope	Acquisitions continue until the specified number of waveforms have been acquired for the enveloped waveform
Measurements	Roll	Measurements are not available until you stop acquisitions

Setting Acquisition Modes

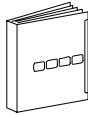
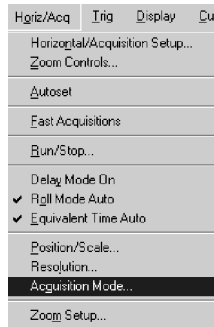
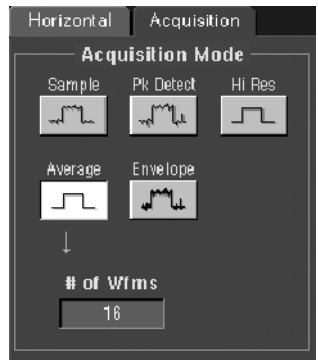
Use this procedure to set the data acquisition mode and specify acquisition start/stop methods. For more information, display online help when performing the procedure.

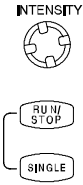

Overview	To set acquisition modes	Control elements and resources
Prerequisites	<ol style="list-style-type: none"> Oscilloscope must be powered on, with horizontal and vertical controls set up. Triggering should also be set up. 	 <p>Refer to page 3-49 for trigger setup.</p>
Access the acquisition modes	<ol style="list-style-type: none"> Select Acquisition Mode from the Horiz/Acq menu to open the Acquisition Mode control window. 	
<p>Select the acquisition mode</p> <p>Set waveform count (Average and Envelope modes only)</p>	<ol style="list-style-type: none"> Click an Acquisition Mode button: <ul style="list-style-type: none"> Sample Peak Detect Hi Res Envelope Average <p>For Average and Envelope modes only, select the number of acquisitions to average or envelope.</p> 	

Overview	To set acquisition modes	Control elements and resources
<p>Set the Stop mode</p>	<ol style="list-style-type: none"> 4. Push the RUN/STOP front-panel button to toggle between starting and stopping acquisitions. 5. Push the SINGLE button to acquire enough waveforms to satisfy the acquisition mode. 	
<p>Select real-time or equivalent-time sampling</p>	<p>To limit the oscilloscope to real-time sampling or let it choose between real-time or equivalent-time sampling:</p> <ol style="list-style-type: none"> 6. Click the Horiz toolbar button, or select the Horizontal/Acquisition Setup command from the Horiz/Acq menu to open the Horizontal/Acquisition Setup control window. Select the Acquisition tab. 7. Select Equivalent Time Auto or Off: <ul style="list-style-type: none"> ■ Auto uses both real-time and equivalent-time sampling as appropriate (see Table 3-2). ■ Off limits the oscilloscope to real-time sampling. 	

Starting and Stopping Acquisition

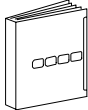
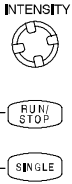

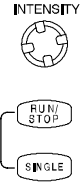
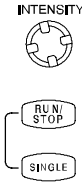
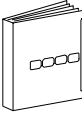
Use this procedure to start and stop data acquisition.

Overview	To start and stop acquisition	Control elements and resources
<p>Prerequisites</p>	<ol style="list-style-type: none"> 1. The horizontal and vertical controls must be set up. Triggering should also be set up. 	 <p>Refer to page 3-25 for control setup and page 3-49 for trigger setup.</p>
<p>Start acquiring</p>	<ol style="list-style-type: none"> 2. Make sure all of the channels to be acquired are turned on (use channel buttons; refer to page 3-8 if needed). Push the front-panel RUN/STOP button to start acquisition. 	

Overview	To start and stop acquisition	Control elements and resources
<p>Stop acquiring</p>	<p>3. Push the RUN/STOP button to stop acquisition. Acquisition will also stop if triggering ceases while in normal trigger mode.</p>	
<p>Take a single acquisition</p>	<p>4. Push the front-panel SINGLE button to start acquiring and acquire enough waveforms to satisfy the acquisition mode.</p>	
<p>For more help</p>	<p>5. Refer to references listed at right.</p>	 <p>Refer to <i>Setting Acquisition Modes</i> on page 3-25.</p>  <p>See page 3-209 for information on online help</p>

Using Roll Mode Use the procedure that follows to set up roll mode acquisitions.

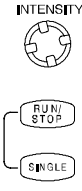
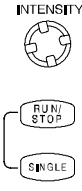
Overview	To set roll mode	Control elements and resources
<p>Prerequisites</p>	<p>1. The horizontal and vertical controls must be set up. Triggering should also be set up.</p>	<div data-bbox="1143 449 1230 562" data-label="Image"> </div> <p data-bbox="1005 579 1386 632">Refer to page 3-25 for acquisition setup and page 3-49 for trigger setup.</p>
<p>Enable roll mode</p>	<p>2. Click the Horiz button bar button to open the Horizontal/ Acquisition Setup control window. Select the Acquisition tab.</p> <p>3. Click Roll Mode Auto to enable roll mode.</p> <p>The resolution, record length, horizontal scale, and number of active channels on are dependent variables. Therefore, the fastest horizontal scale setting when Roll mode starts is 100 ms/div, the record length is 500 (resolution is 2 ms), the acquisition mode is either Sample or Peak Detect, and 1 or 2 channels must be on. As the record length or the number of on channels grows, the time per division required to enter Roll mode is slower.</p> <hr/> <p>Note: Envelope and Average acquisition modes inhibit roll mode. Hi Res roll mode starts when the resolution is 4 ms or greater.</p>	<div data-bbox="1143 701 1222 737" data-label="Image"> </div> <div data-bbox="1122 821 1252 1003" data-label="Image"> </div>

Overview	To set roll mode	Control elements and resources
<p>Enable single sequence roll mode</p>	<p>4. Push the SINGLE button to start and acquire enough waveforms to satisfy the acquisition mode. The acquisition mode must be either Sample or Peak Detect.</p>	
<p>Turn off roll mode acquisitions</p>	<p>5. To stop acquisitions in roll mode:</p> <ul style="list-style-type: none"> ■ If you are not in Single Sequence, push RUN/STOP to stop roll mode. ■ If you are in Single Sequence, roll mode acquisitions stop automatically when a complete record is acquired. 	
<p>Disable roll mode</p>	<p>6. Click the Horiz button bar button to open the Horizontal/Acquisition Setup control window. Select the Acquisition tab.</p> <p>7. Click Roll Mode Off to disable roll mode NEEDS PICTURE. Roll mode is also disabled when you set the horizontal scale to 200 ms per division or faster. At record lengths greater than 500 points, the time per division to turn off roll mode becomes slower.</p> <hr/> <p><i>Note: Switching to Envelope or Average acquisition mode will also turn off roll mode.</i></p> <hr/>	

Acquisition Control Background

This section contains background information on the data sampling and acquisition process that can help you more effectively set up the acquisition window of each channel. This section describes:

- The acquisition hardware.
- The sampling process, sampling modes, and the waveform record.
- Both the normal and Fast Acquisitions acquisition cycles.

Acquisition Hardware

Before a signal can be acquired, it must pass through the input channel where it is scaled and digitized. Each channel has a dedicated input amplifier and digitizer as shown in Figure 3-9; each channel can produce a stream of digital data from which the oscilloscope extracts waveform records. Refer to *Signal Connection and Conditioning* on page 3-4 for further description of scaling, positioning, and DC offsetting of channels.

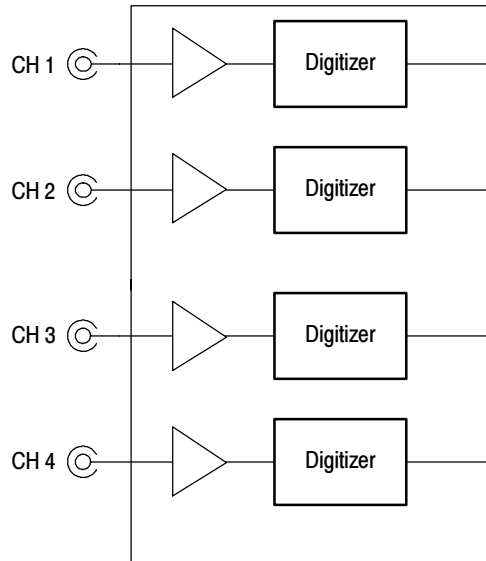

Figure 3-9: Digitizer configuration

Sampling Process

Acquisition is the process of sampling an analog signal, converting it into digital data, and assembling it into a waveform record, which is then stored in acquisition memory. Sampling, then, is the process that provides a waveform record per trigger event (see Figure 3-11 on page 3-32). The signal parts within the vertical range of the amplifier are digitized. See Figure 3-10.

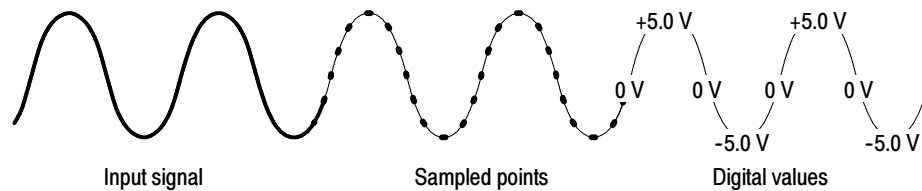

Figure 3-10: Digital acquisition — sampling and digitizing

Sampling Modes

The oscilloscope acquisition system can process the data as it is acquired, averaging or enveloping the waveform data to produce enhanced waveform records. Once the waveform record exists (enhanced or not), you can use the postprocessing capabilities of the oscilloscope to further process that record: perform measurements, waveform math, and so on. Refer to *Acquisition Modes* on page 3-21 for a description of the acquisition modes.

Waveform Record

While sampling on the input signal provides the data that makes up the waveform record for any given channel, the oscilloscope builds the waveform record through use of some common parameters (“common” means they affect the waveforms in all channels).

Figure 3-11 shows how these common parameters define the waveform record. They define how much data is taken and from where in the data stream. The parameters are:

- *Sample Interval*: The time between sample points taken during acquisition.
- *Record Length*: The number of samples required to fill a waveform record.
- *Trigger Point*: The trigger point marks the reference zero time in a waveform record. All waveform samples are located in time (minus and/or plus) with respect to the trigger point.
- *Horizontal Position*: When horizontal delay is off, the horizontal position is the time from the first sample taken (first point in the waveform record) to the trigger point (in percent of samples before the trigger). The trigger point and the horizontal reference are at the same time in the waveform record.

When horizontal delay is on, the HORIZONTAL POSITION knob controls the horizontal delay time. The horizontal delay is the time from the trigger point to the horizontal reference.

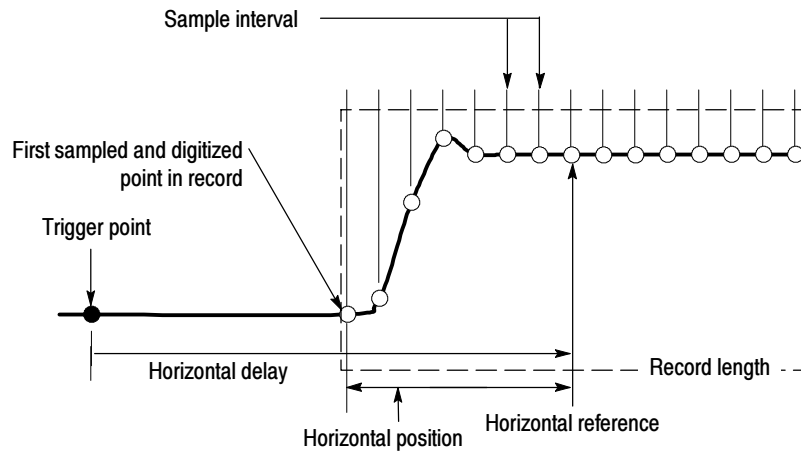

Figure 3-11: The waveform record and its defining parameters (horizontal delay on)

As Figure 3-11 shows, the oscilloscope acquires points in order from left to right.

When all of the points in the waveform record have been sampled and digitized, the waveform record is stored in acquisition memory and becomes available for display (or use in math waveforms, storage, and so on).

For a control-oriented discussion of the waveform record, refer to *Horizontal Acquisition Window Considerations* on page 3-18 and *Horizontal Scale vs. Record Length vs. Sample Interval vs. Resolution* on page 3-19.

Real-time Sampling

The two general methods of sampling are *real-time* and *equivalent-time*. This oscilloscope uses both equivalent- and real-time sampling.

In real-time sampling, the oscilloscope digitizes all of the points it acquires after *one* trigger event (see Figure 3-12). Always use real-time sampling to capture single-shot or transient events.

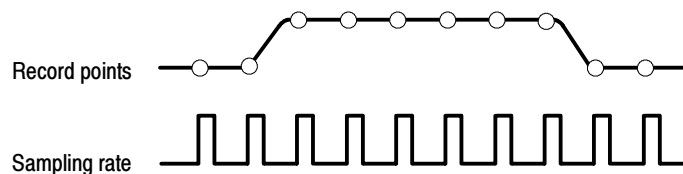

Figure 3-12: Real-time sampling

Equivalent-time Sampling

The oscilloscope uses equivalent-time sampling to extend its sample rate beyond its real-time maximum sampling rate, but only under two conditions:

- Equivalent Time Auto must be selected. (Acquisition tab of the Horizontal/Acquisition Setup control window).
- The time base of the oscilloscope is set to a sampling rate that is too fast to allow it to get enough samples with which to create a waveform record using real-time sampling.

If both conditions are met, the oscilloscope takes a few samples with each trigger event and eventually obtains enough samples to construct a waveform record. In short, the oscilloscope makes *multiple* acquisitions of a *repetitive* waveform to obtain the sample density required for one complete waveform record. (See Figure 3-13.) Equivalent-time sampling should only be used on repetitive signals.

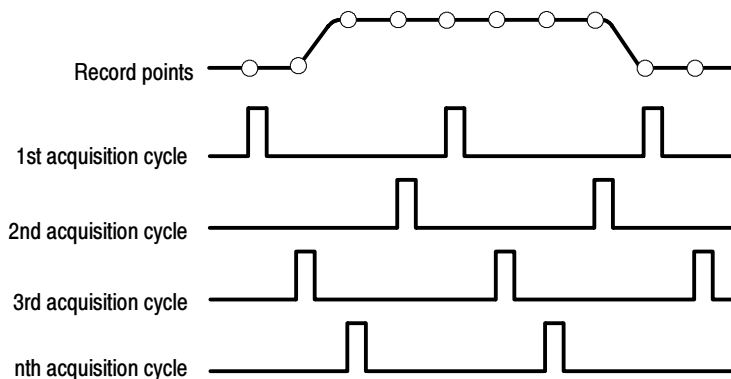

Figure 3-13: Equivalent-time sampling

The sampling speeds and the number of channels you choose affect the mode that the oscilloscope uses to sample waveforms:

- The oscilloscope always uses real-time sampling at slower time base settings. Faster time settings force the oscilloscope to switch from real-time sampling to equivalent-time sampling, if Equivalent Time Auto is enabled.
- The oscilloscope extends the limit at which it must switch from real-time sampling by using the digitizers of channels that are turned off to sample the channel or channels that are turned on.

Table 3-2 shows the time base setting(s) at which the switch from real-time sampling (**RT**) to equivalent-time sampling (**ET**) occurs for your oscilloscope. This information applies to all TDS5000 models.

Table 3-2: Sampling mode selection

Channels on	1	2	3 or 4
Time base			
≥ 800 ps/pt	RT	RT	RT
400 ps/pt	RT	RT	ET
200 ps/pt	RT	ET	ET
≤ 100 ps/pt	ET	ET	ET

The type of equivalent-time sampling the oscilloscope uses is called *random equivalent-time sampling*. Although it takes the samples sequentially in time, it takes them randomly with respect to the trigger. Random sampling occurs because the oscilloscope sample clock runs asynchronously with respect to the input signal and the signal trigger. The oscilloscope takes samples independently of the trigger position and displays them based on the time difference between the sample and the trigger.

Interpolation

Your oscilloscope can interpolate between the samples it acquires, and does so only when it does not have all of the actual samples it needs to fill its displayed waveform. For instance, if you set ZOOM to progressively larger amounts of expansion, the oscilloscope interpolates to create the intervening points in the displayed waveform. There are two options for interpolation: linear or $\sin(x)/x$. (The oscilloscope can also use equivalent-time sampling to acquire more samples; refer to *Equivalent-time Sampling* on page 3-33.)

- *Linear interpolation* computes record points between actual acquired samples by using a straight line fit. It assumes that all of the interpolated points fall in their appropriate point in time on that straight line. Linear interpolation is useful for waveforms with fast rise times, such as pulse trains.
- *Sin(x)/x interpolation* computes record points using a curve fit between the actual values acquired. It assumes that all of the interpolated points fall along that curve. This is particularly useful when acquiring more rounded waveforms such as sine waves. $\sin(x)/x$ interpolation is also appropriate for general use, although it may introduce some overshoot or undershoot in signals with fast rise times.

NOTE. When using either type of interpolation, you may want to set the display style so that the real samples are intensified and interpolated samples are dimmed. See Display Style on page 3-107.

Interleaving

The oscilloscope can interleave its channels to attain higher digitizing rates without equivalent-time sampling. The oscilloscope applies the digitizing resources of unused channels (that is, channels that are turned off) to sample those that are in use (turned on). Table 3-3 lists how interleaving more than one digitizer to sample a channel extends the maximum digitizing rate.

Once you set the horizontal scale to exceed the maximum digitizing rate for the number of channels in use (refer to Table 3-3), the oscilloscope will not be able to get enough samples to create a waveform record. At that point, the oscilloscope will switch from real- to equivalent-time sampling to obtain additional samples. (Refer to *Equivalent-time Sampling* on page 3-33.)

Table 3-3: How interleaving affects sample rate

Number of channels in use	Maximum digitizing rate when real-time sampling (all models)
One	5 GS/sec
Two	2.5 GS/sec
Three or Four	1.25 GS/sec

Using Fast Acquisitions Mode

Fast Acquisitions mode reduces the dead time between waveform acquisitions that normally occurs when digitizing storage oscilloscopes (DSOs) acquire waveforms. This enables Fast Acquisitions mode to capture and display transient events, such as glitches or runt pulses, often missed during longer dead times that are a part of normal DSO operation. Fast Acquisitions mode can also display waveform phenomena at an intensity that reflects their rate of occurrence.

Fast XY and XYZ modes also provide intensity information by accepting continuous, nontriggered data from the input channels.

Several modes/features are incompatible with Fast Acquisitions mode:

- FastFrame mode
- Zoom mode
- Peak Detect, Envelope, Average, and Single Sequence acquisition modes

- Interpolation (normal acquisition mode is used instead)
- Vectors in equivalent-time sampling mode (waveforms are displayed as dots instead)
- Saving nonactive waveforms
- Math waveforms
- Measurements

Using Fast Acquisitions

Consider the mode you want to use to acquire data:

Automatic Selection. Fast Acquisitions automatically selects record length and sample rate to optimize the displayed image by minimizing dead time. Fast Acquisitions selects sample rates up to 1.25 GS/s and record lengths up to 1,000,000 points, and compresses them to 500 pixels to produce the maximum display content.

Waveform Capture Rate. Figures 3-14 and 3-15 illustrate how Fast Acquisitions mode differs from the normal acquisition mode used by digital storage oscilloscopes. Note that normal mode follows a “capture waveform-digitize waveform-update waveform memory-display waveform” cycle. Normal mode misses events occurring during the long dead times. Typical waveform capture rates are 50 waveforms per second.

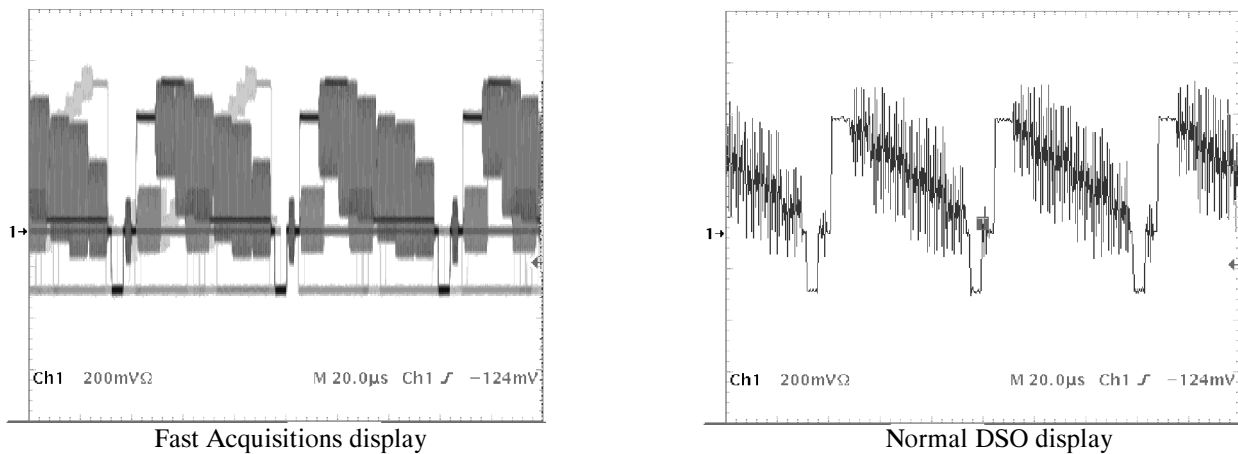
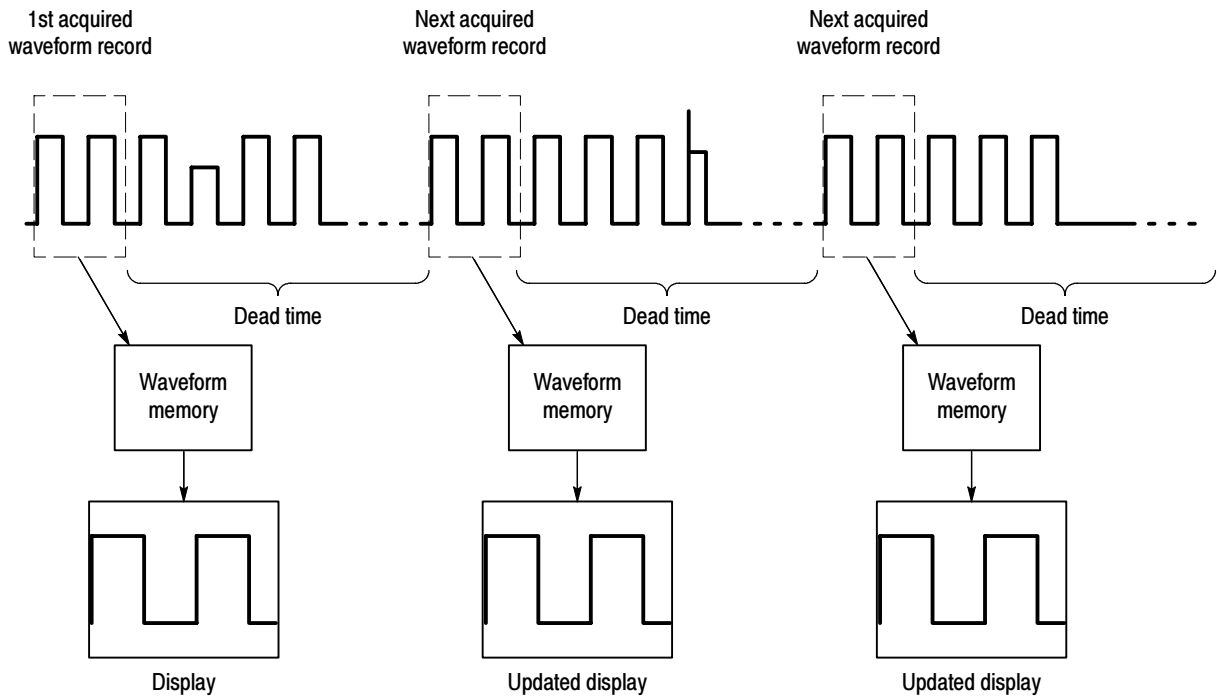

Figure 3-14: Normal DSO and Fast Acquisitions displays

Fast Acquisitions mode increases the waveform capture rate to up to 100,000 waveforms per second, updating the waveform array many times between displays. This very fast capture rate greatly increases the probability that runs, glitches, and other infrequent events will accumulate in waveform memory. The oscilloscope then updates the display at the normal display rate. You can control the waveform intensity using adjustable or automatic brightness (refer to page 3-40 for more information).

Fast Acquisitions mode adds intensity or gray scale information to each point in the waveform array like an analog oscilloscope. The waveform array is a two dimensional array of display pixels. Display pixel values are incremented each time they are written by a waveform acquisition.

Normal DSO Mode



Fast Acquisitions Mode

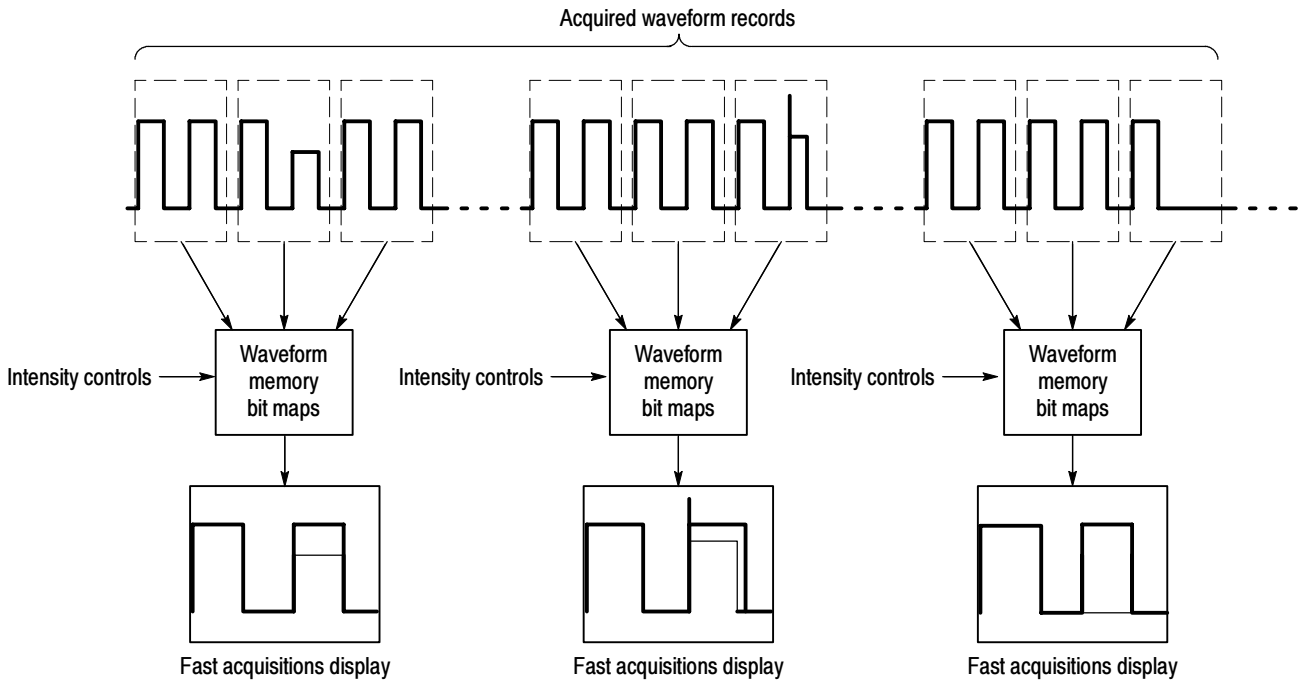
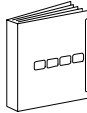
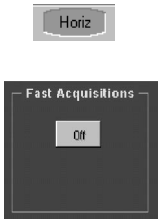
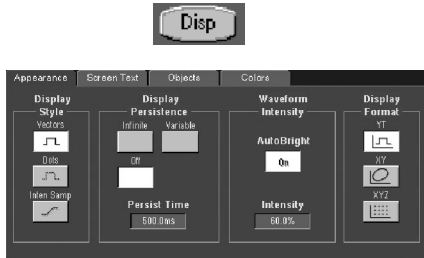
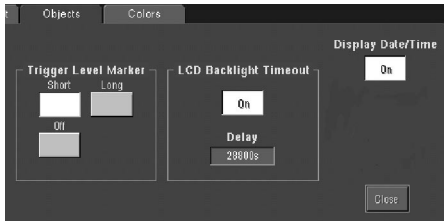
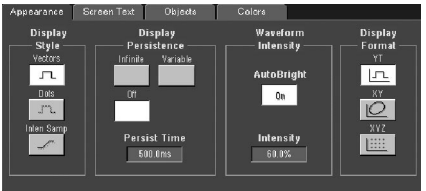
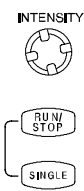
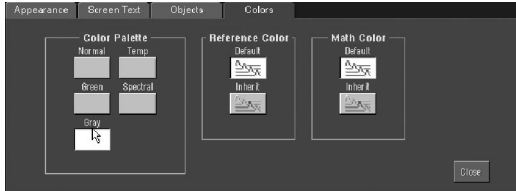



Figure 3- 15: Normal DSO Acquisition and Display mode versus Fast Acquisitions mode

Turning Fast Acquisitions On and Off Use this procedure to set up Fast Acquisitions mode.

Overview	To turn Fast Acquisitions on and off	Control elements and resources
<p>Prerequisites</p>	<p>1. The horizontal and vertical controls must be set up. Triggering should also be set up.</p>	 <p>Refer to page 3-25 for acquisition setup and page 3-49 for trigger setup.</p>
<p>Enable Fast Acquisitions mode</p>	<p>2. Click the Horiz toolbar button to open the Horizontal/Acquisition Setup control window. Select the Acquisition tab.</p> <p>3. Click Fast Acquisitions to toggle Fast Acquisitions, or push the front-panel FastAcq button.</p> <p>On is the default mode. Fast Acquisitions mode will stay on until you turn it off or until you select an incompatible mode that inhibits Fast Acquisitions.</p>	
<p>Set the display appearance</p>	<p>4. Click the DISP toolbar button, or select the Display Setup command from the Display menu. The Display Control window opens on the Appearance tab.</p> <p>5. Click a Display Style button, either Vectors, Dots, or Inten Samp. Dots is the default.</p> <p>6. For the Display Persistence, click either Off or Variable. Off is the default, and erases the screen each time a new waveform array is displayed. Variable persistence is explained on page 3-106.</p> <p>7. If you select Variable, click Persist Time and adjust the persistence time (decay rate).</p>	
<p>Set the display readout options</p>	<p>8. Select the Display Setup control window Objects tab.</p> <p>9. Click Display Date/Time to toggle the date/time display On and Off.</p>	

Overview	To turn Fast Acquisitions on and off	Control elements and resources
<p>Adjust the intensity</p>	<p>10. Select the Display Setup control window Appearance tab.</p> <p>11. Click the Waveform Intensity AutoBright button to toggle AutoBright On and Off.</p> <ul style="list-style-type: none"> ■ On automatically sets the maximum intensity to the value of the most frequent event. ■ Off creates a display like an analog oscilloscope. The displayed brightness depends on the trigger rate. <p>12. Rotate the front-panel INTENSITY knob to adjust the intensity of displayed waveforms, or click the Intensity control and enter the intensity value with the keypad or general purpose knob.</p>	 
<p>Select the color palette</p>	<p>13. Select the Display Setup control window Color tab.</p> <p>14. Click the a Color Palette button. In Fast Acquisitions mode, Temp and Spectral show more detail than the other color palettes.</p> <p>For a definition of each color palette, refer to <i>Color Palette</i> on page 3-107.</p>	 

Setting the Display Format The oscilloscope displays waveforms in one of three formats: YT, XY, or XYZ. Use the procedure that follows to set the display format.

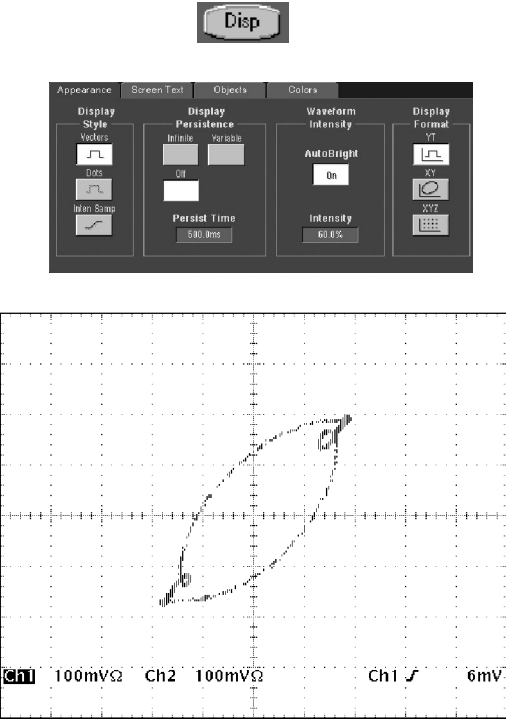
Overview	To set display format	Control elements and resources
<p>Select the format</p>	<ol style="list-style-type: none"> Click the DISP toolbar button. The Display Setup control window opens on the Appearance tab. Select between the YT, XY, and XYZ display formats: <ul style="list-style-type: none"> YT is the conventional oscilloscope display format. It shows a signal voltage (the vertical axis) as it varies over time (the horizontal axis). XY compares the voltage levels of two waveform records point by point (see Figure 3-16). That is, the oscilloscope displays a graph of the data of one channel versus another. The data is a continuous stream, and there are no waveform records. XY requires Fast Acquisitions mode, and is particularly useful for studying phase relationships. When you set the vertical position offset to center the display in YT mode, the XY display is at center screen, and each division of display in YT mode produces a division of display in XY mode. <p>In XY format, any channel displayed is assigned to the axis indicated in Table 3-4 and displayed as part of an XY pair. If only one source is displayed, the oscilloscope automatically turns on the other to complete the pair. Moreover, once XY is on, selecting either source turns the pair on; turning off either removes both sources from the display.</p> <p>XY format is a dot-only display, although it can have persistence. The Vector style selection has no effect when you select XY format.</p> XYZ format compares the voltage levels of the CH 1 (X) and CH 2 (Y) waveform records point-by-point as in XY format. XYZ requires Fast Acquisitions mode. The displayed waveform intensity is modulated by the CH 3 (Z) waveform record. XYZ format is not triggered. A -5 division signal (including position and offset) on CH 3 produces a blank screen; a +5 division signal produces full intensity. <p>If in XY or XYZ, histograms are allowed and horizontal controls are ignored. The XYZ format is only available on the TDS5054 and TDS5104 models.</p>	 <p>The figure shows two parts. The top part is a screenshot of the 'Disp' control window, which is divided into several tabs: Appearance, Screen Text, Objects, and Colors. The 'Appearance' tab is active, showing settings for Display Style (Waveform, Dots, Inten Samp), Persistence (Initial, Persist), Waveform Intensity (AutoBright, On, 60.8%), and Display Format (YT, XY, XYZ). The 'XY' format is selected. The bottom part is a screenshot of the oscilloscope screen showing an XY display. The screen is a grid with a central origin. Two waveforms are plotted as a continuous stream of dots, forming a closed, roughly elliptical shape. The axes are labeled 'Ch1' and 'Ch2'. At the bottom of the screen, there are labels for 'Ch1 100mVΩ', 'Ch2 100mVΩ', and 'Ch1 6mV'.</p> <p>Figure 3- 16: Fast Acquisitions XY display</p>

Overview	To set display format	Control elements and resources
For more help	3. Access the online help for more information on the controls described in this procedure.	

Table 3-4: XY format pairs

XY Pair	X-Axis source	Y-Axis source
Ch 1 and Ch 2	Ch 1	Ch 2
Ch 3 and Ch 4	Ch 3	Ch 4

Using FastFrame

FastFrame is an acquisition mode that lets you capture many records in a larger record, and then view and measure each record individually.

FastFrame lets you quickly capture multiple acquisitions in the acquisition memory of a single channel. Figure 3-17 shows how FastFrame combines the desired captured frames into one larger waveform. For example, FastFrame would let you store 4000 frames (depending on the record length option installed) of 500 samples each into one waveform.

FastFrame mode lets you jump to and view the desired frame. Time Stamps can display the absolute trigger time for a specific frame and the relative time between triggers of two specified frames. FastFrame lets you compare different waveforms. Math is done on each frame.

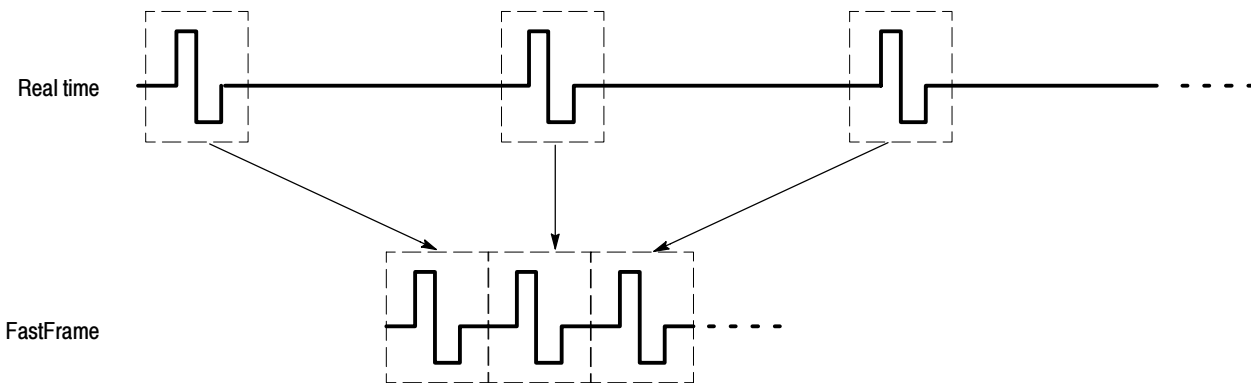

Figure 3-17: FastFrame

FastFrame is not compatible with the following features or modes:

- Equivalent Time
- Histograms
- Fast Acquisitions
- Average
- Envelope

Using FastFrame Acquisitions

Consider the following operating characteristics when using FastFrame:

- You can push **RUN/STOP** to terminate a FastFrame sequence. If any frames were acquired, they are displayed. If no frames were acquired, the previous FastFrame waveform is displayed.
- Because FastFrame introduces additional processing time into the operation cycle of acquire, process, and display, it is best to use Single Sequence Acquisition (see Acquire menu, Stop After menu). With Single Sequence selected, you will see the current acquisition sequence; otherwise, the display lags the current sequence by one sequence. You can also see the current sequence by pushing the RUN/STOP button to stop the acquisition.
- FastFrame greatly reduces the minimum trigger holdoff time, enabling you to acquire and store records at rates of up to 225,000 captures per second (until the number of frames requested has been acquired). FastAcq mode also provides exceptionally fast acquisition rates. Both modes have advantages. FastFrame preserves the actual data associated with each trigger event for further analysis or visual inspection, but only acquires at the fast rate for short bursts of time. FastAcq mode combines the data from all trigger events into a single pixel map, but can acquire at exceptionally fast rates continuously, not just for short bursts.

To Set FastFrame Mode Use the procedure that follows to set up FastFrame mode acquisitions.

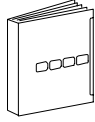
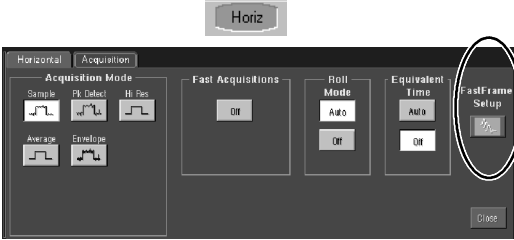
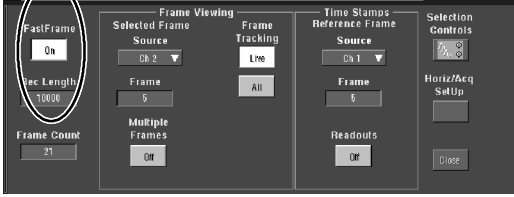
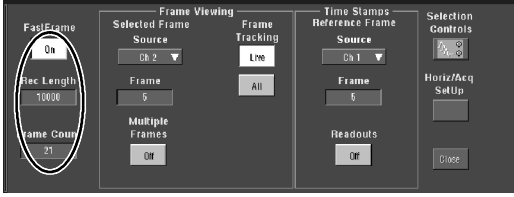
Overview	To set FastFrame mode	Control elements & resources
<p>Prerequisites</p>	<p>1. The horizontal and vertical controls must be set up. Set up the triggering also.</p>	 <p>See page page 3-25 for acquisition setup & page 3-49 for trigger setup.</p>
<p>To set FastFrame mode</p>	<p>2. Click the Horiz button. Select the Acquisition tab from the Horiz/Acq control window. Click FastFrame Setup to display the FastFrame Setup control window.</p> <p>3. Click FastFrame to toggle FastFrame to On.</p>	 
<p>Set frame length</p>	<p>4. Click Rec Length, and set the number of samples per frame.</p> <p>Record length is the number of samples in each acquisition.</p>	

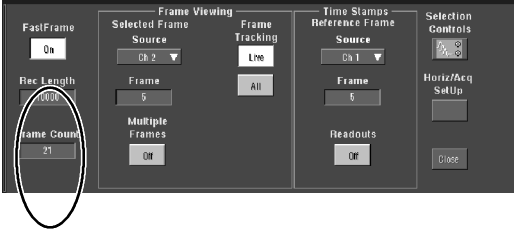
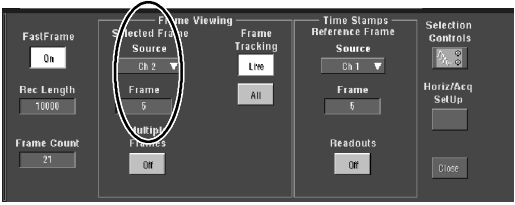
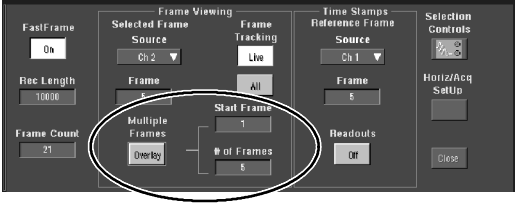
Overview	To set FastFrame mode	Control elements & resources
<p>Set frame count</p>	<p>5. Click Frame Count, and enter the number of frames to acquire per waveform record.</p> <p>Frame count is the number of acquisitions to store in the acquisition memory of the channel. The oscilloscope will set the record length to a value greater than or equal to the product of the frame count and the frame length. If the product of the record length and the frame count exceeds the available memory, the oscilloscope will reduce the record length or frame count in size such that the product will fit the amount of memory available. Available memory is a combination of acquisition memory and system memory.</p>	
<p>Select the frame to view</p>	<p>6. In the Frame Viewing controls, click Source and select the source of the frame you want to view.</p> <p>7. In the Frame Viewing control, click Frame and use the general purpose knob or keypad to enter the number of the specific frame you want to view. The frame that you select appears on the display.</p>	
<p>To view multiple frames</p>	<p>8. In the Frame Viewing controls, click Multiple Frames to select Overlay.</p> <p>9. In the Frame Viewing control, click StartFrame and use the general purpose knob or keypad to enter the number of the first frame in the frame sequence that you want to view.</p> <p>10. In the Frame Viewing control, click # of Frames and use the general purpose knob or keypad to enter the total number of frames that you want to view.</p> <p>The frames within the range that you selected are displayed superimposed over each other in the color of the Source channel. The Selected Frame is also superimposed on the display of frames, but in a dark blue color for easy identification. (You may find it difficult to distinguish the dark blue Selected Frame if you have selected Spectral or Temp for the Color Palette.)</p>	

Time Stamping Frames

Use Time Stamps to display the absolute trigger time for a specific frame and the relative time between triggers of two specified frames. To use FastFrame Time Stamps, do the following steps:

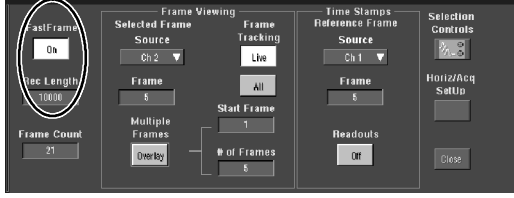
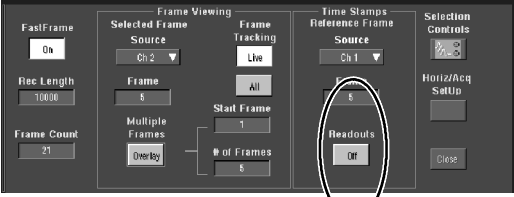
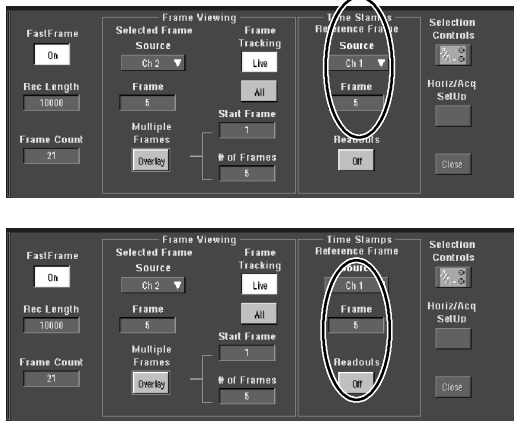
Overview	Time stamping frames	Control elements & resources
<p>Prerequisites</p>	<ol style="list-style-type: none"> FastFrame mode should be set up as described in the previous example. Turn on FastFrame as described starting on page 3-44. 	
<p>Turn readouts on or off</p>	<ol style="list-style-type: none"> In the Time Stamps controls, touch Readouts to toggle time stamp readouts on or off: <ul style="list-style-type: none"> On displays time stamp readouts (see Figure 3-18) Off turns off the display of time stamp readouts <p>The displayed time uses the following format:</p> <pre>Sel Ch# F xxx DD MMM YYYY HH:MM:SS.mmm μμμ nnn ppp Ref Ch# F xxx DD MMM YYYY HH:MM:SS.mmm μμμ nnn ppp Δ DD MMM YYYY HH:MM:SS.mmm μμμ nnn ppp</pre> <p>Where: Sel and Ref Ch# F xxx are the selected or reference frame number DD MMM YYYY is the date (day, month, and year) HH:MM:SS.mmm, is the clock time (hours, minutes, seconds, and milliseconds) μμμ,nnn,ppp is a fraction of a second (to picoseconds)</p> 	
<p>Select the reference frame</p>	<ol style="list-style-type: none"> In the Time Stamps controls, touch Source and select the source of the reference frame. In the Time Stamps controls, touch Frame and use the general purpose knob or keypad to enter the number of the reference frame. This value sets the starting frame when measuring the relative time between two frames. 	

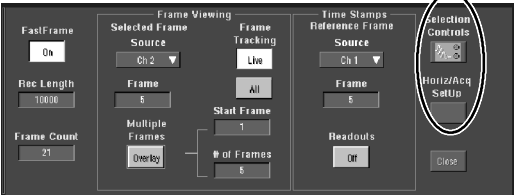
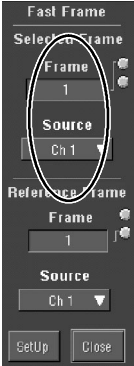
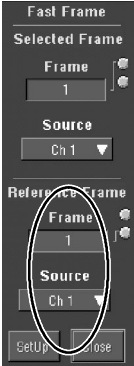
Overview	Time stamping frames	Control elements & resources
<p>Select the FastFrame and time stamps selection controls</p>	<p>You may set the Selected Frame and Reference Frame as previously shown or you can set them from the Selection Controls window.</p> <ol style="list-style-type: none"> Click Selection Controls from the Time Stamps control window to display the FastFrame controls. In the FastFrame controls window, touch Selected Frame Source and select the source of the frame you want to view. Under Selected Frame, click Frame and use the general purpose knob or keypad to enter the number of the specific frame you want to view and take time stamps on. The frame you select appears on the display. <p>Note: The Δ is the selected time stamp - the reference time stamp.</p> <ol style="list-style-type: none"> Click the Reference Frame Source and select the source of the reference frame. Click Frame and use the general purpose knob or keypad to enter the number of the reference frame. 	  

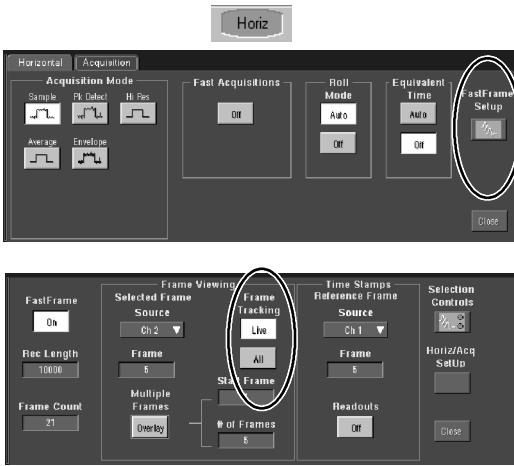
Overview	Time stamping frames	Control elements & resources
<p>To lock the reference position frames</p>	<p>10. Touch the Horiz button. Select the Acquisition tab from the Horiz/Acq control window. Touch FastFrame Setup to display the FastFrame Setup control window.</p> <p>Note: You can also get the FastFrame Setup control window by pushing the Set Up button on the Selection Controls window.</p> <p>11. Touch either Frame Tracking Live or All to lock the reference and position frames together. When the frames are locked, they maintain the same relative distance from each other when either frame is adjusted:</p> <ul style="list-style-type: none"> ■ Live locks together the channel and math waveforms. All reference waveforms are locked together, but they are separate from the channel and math waveforms. ■ All locks together all channel, math, and reference waveforms; adjusting one waveform adjusts all waveforms. 	

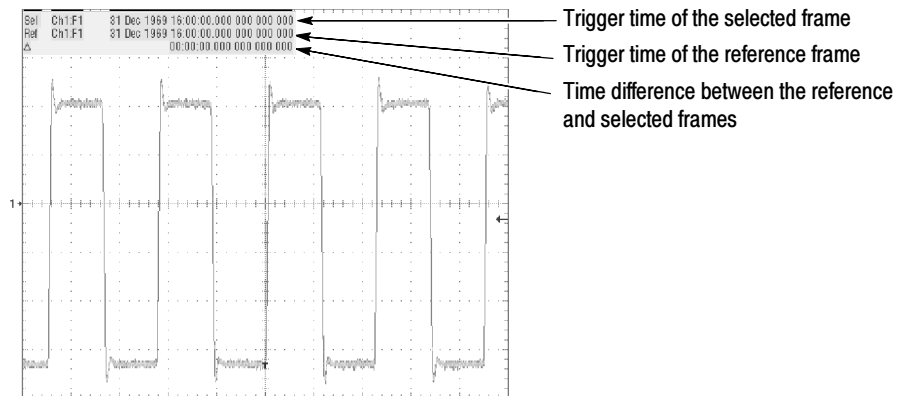

Figure 3-18: FastFrame time stamp

Triggering

To use the oscilloscope to sample a signal and digitize it into a waveform record that you want to process, you need to set up the trigger conditions. This section provides background on and procedures for using the basic elements of triggering:

- *Trigger Concepts:* Basic principles of triggering including type, source, coupling, holdoff, mode, and so on.
- *Triggering from the Front Panel:* Using the front-panel triggering controls.
- *Additional Trigger Parameters:* Accessing common trigger functions in the Trigger Setup control window.
- *Advanced Triggering:* Trigger types that you can use to trigger the oscilloscope on specific conditions.
- *Sequential Triggering:* Combining the A (Main) and B (Delayed) trigger systems to capture unique events.

Figure 3-19 shows how triggers fit into the overall oscilloscope operation.

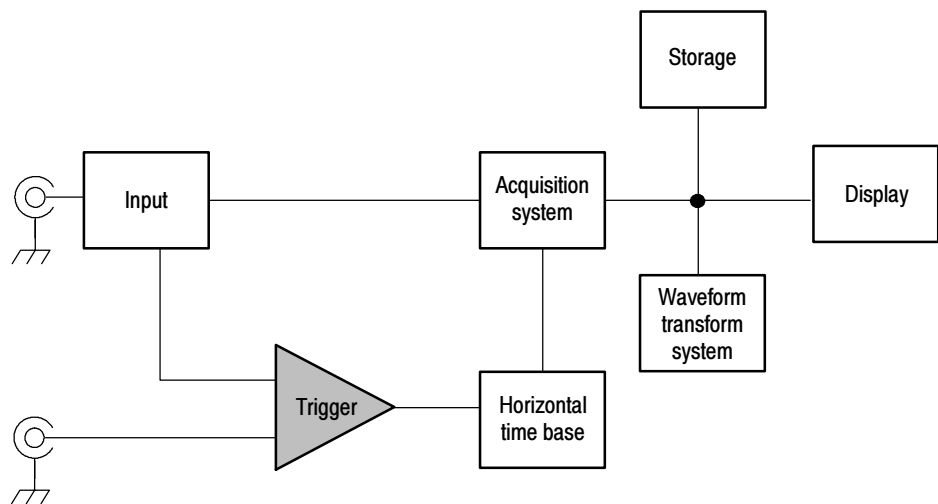

Figure 3-19: Oscilloscope System Overview: Triggering

Triggering Concepts

Triggers create meaningful waveforms from signal displays. (See Figure 3-20.) This oscilloscope has simple edge triggers as well as a variety of advanced triggers.

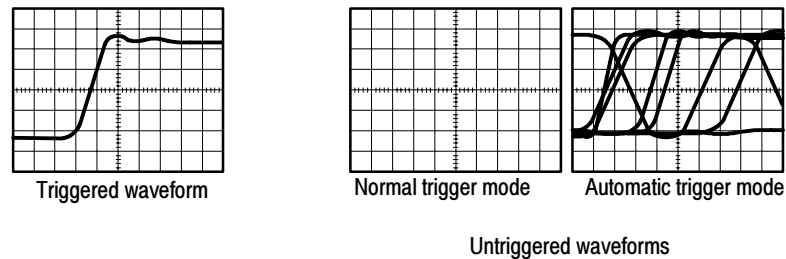

Figure 3-20: Triggered versus untriggered displays

The Trigger Event

The trigger event establishes the time-zero point in the waveform record. All waveform record data are located in time with respect to that point. The oscilloscope continuously acquires and retains enough sample points to fill the pretrigger portion of the waveform record (that part of the waveform that is displayed before, or to the left of, the triggering event on screen). When a trigger event occurs, the oscilloscope starts acquiring samples to build the posttrigger portion of the waveform record (displayed after, or to the right of, the trigger event). Once a trigger is recognized, the oscilloscope will not accept another trigger until the acquisition is complete and the holdoff time has expired.

Trigger Sources

The trigger source provides the signal that triggers acquisition. Use a trigger source that is synchronized with the signal that you are acquiring and displaying. You can derive your trigger from the following sources:

- *Input channels* are the most commonly used trigger sources. You can select any one of the two or four input channels, depending on your model. The channel you select as a trigger source will function whether it is displayed or not.
- *AC Line Voltage* is often used to look at signals related to the power line frequency (for example, signals from devices such as lighting equipment and power supplies). Because the oscilloscope generates the trigger from the power line, you do not have to use a channel input.
- *Auxiliary Trigger (AUX IN)* provides a fifth source that you can use as a trigger input when you need to use the four input channels for other signals. For example, you might want to trigger on a clock while displaying four other logic signals. To use the auxiliary trigger, connect the signal to the auxiliary input connector on the front panel. The input connector is not

compatible with most probes, nor can you display the auxiliary trigger signal.

Trigger Types

The oscilloscope provides the following trigger type categories:

- *Edge* triggers are the simplest and most commonly used trigger type, used with both analog and digital signals. An edge trigger event occurs when the trigger source passes through a specified voltage level in the specified direction (rising or falling signal voltage).
- *Pulse* triggers are special-purpose triggers that are primarily used with digital signals. The following types of pulse triggers are available: Glitch, Runt, Window, Width, Transition, and Timeout. Pulse triggers are available on the main trigger only.
- *Logic* triggers are special-purpose triggers that are primarily used with digital logic signals. Two of the types, Pattern and State, trigger the oscilloscope based on the Boolean operator you select for the trigger sources. A third type, Setup and Hold, triggers when data in one trigger source changes state within the setup and hold times that you specify relative to a clock in another trigger source. Logic triggers are available on the main trigger only.
- *Video* triggers are used to trigger the oscilloscope on specified fields or lines of a video signal. You can use one of several preset video signal formats or set a custom format.

Trigger Modes

The trigger mode determines how the oscilloscope behaves in the absence of a trigger event:

- *Normal* trigger mode enables the oscilloscope to acquire a waveform only when it is triggered. If no trigger occurs, the oscilloscope does not acquire a waveform, and the last waveform record acquired remains “frozen” on the display. If no last waveform exists, no waveform is displayed (see Figure 3-20).
- *Auto* trigger mode enables the oscilloscope to acquire a waveform even if a trigger does not occur. Auto mode uses a timer that starts after a trigger event occurs. If another trigger event is not detected before the time out, the oscilloscope forces a trigger. The length of time it waits for a trigger event depends on the time base setting.

Auto mode, when forcing triggers in the absence of valid triggering events, does not synchronize the waveform on the display (see Figure 3-20). In other words, successive acquisitions are not triggered at the same point on the waveform; therefore, the waveform will appear to roll across the screen. If valid triggers occur, the display will become stable.

Trigger Holdoff

Trigger holdoff can help stabilize triggering. When the oscilloscope recognizes a trigger event, it disables the trigger system until acquisition is complete. In addition, the trigger system remains disabled during the holdoff period that follows each acquisition. Adjust holdoff to obtain stable triggering when the oscilloscope is triggering on undesired trigger events, as shown in Figure 3-21.

A digital pulse train is a good example of a complex waveform. Each pulse looks like any other, so many possible trigger points exist. Not all of these will result in the same display. The holdoff period allows the oscilloscope to trigger on the correct edge, resulting in a stable display.

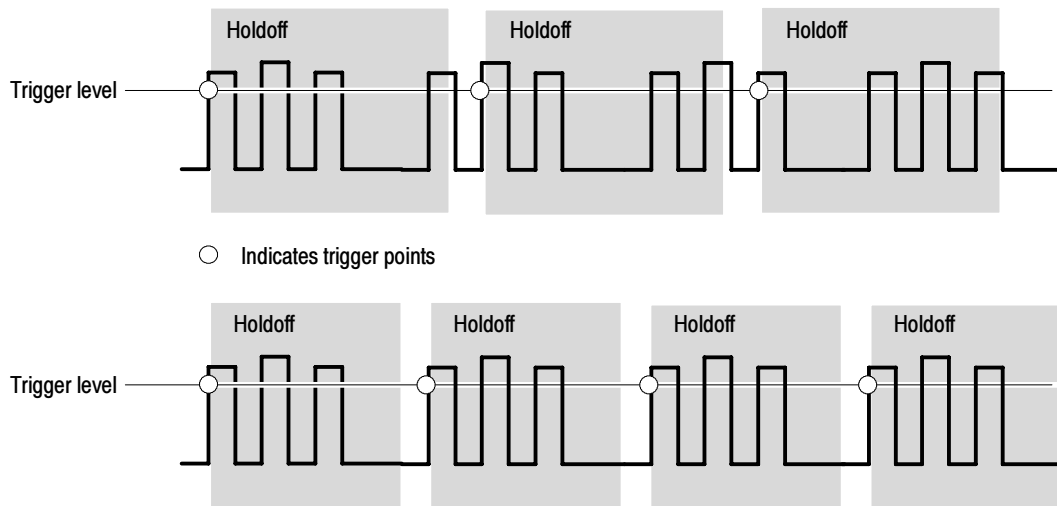

At the longer holdoff time for the top waveform, unstable triggering occurs. With a shorter holdoff set for the bottom waveform, triggers all occur on the first pulse in the burst to remedy the unstable trigger.

Figure 3-21: Holdoff adjustment can prevent unwanted triggers

The Holdoff setting range is 250 ns (minimum holdoff available) to 12 seconds (maximum holdoff available). To see how to set holdoff, refer to *Set Holdoff* on page 3-59. You can also set a default holdoff. The default holdoff is the general purpose holdoff for most applications and varies with the horizontal scale. It is equal to five times the current horizontal scale setting.

Trigger Coupling

Trigger coupling determines what part of the signal is passed to the trigger circuit. Edge triggering can use all available coupling types: AC, DC, Low Frequency Rejection, High Frequency Rejection, and Noise Rejection. All of the advanced trigger types use DC coupling only. See *Set the Trigger Coupling* on page 3-56 for a description of each coupling type.

Horizontal Position

Horizontal position is an adjustable feature that defines where the trigger occurs on the waveform record. It lets you choose how much the oscilloscope acquires before and after the trigger event. The part of the record that occurs before the trigger is the *pretrigger* portion. The part that occurs after the trigger is the *posttrigger* portion.

Pretrigger data can be valuable when troubleshooting. For example, if you are trying to find the cause of an unwanted glitch in your test circuit, you can trigger on the glitch and make the pretrigger period large enough to capture data before the glitch. By analyzing what happens before the glitch, you may uncover information that helps you find the source of the glitch.

Slope and Level

The slope control determines whether the oscilloscope finds the trigger point on the rising or the falling edge of a signal (see Figure 3-22). Set the trigger slope by pushing the SLOPE button on the front panel to toggle between the positive-going and negative-going edge.

The level control determines where on that edge the trigger point occurs. (see Figure 3-22.) You can set the trigger level with the LEVEL knob on the front panel. Push the LEVEL knob to automatically set the trigger level to the 50% amplitude point of the signal.

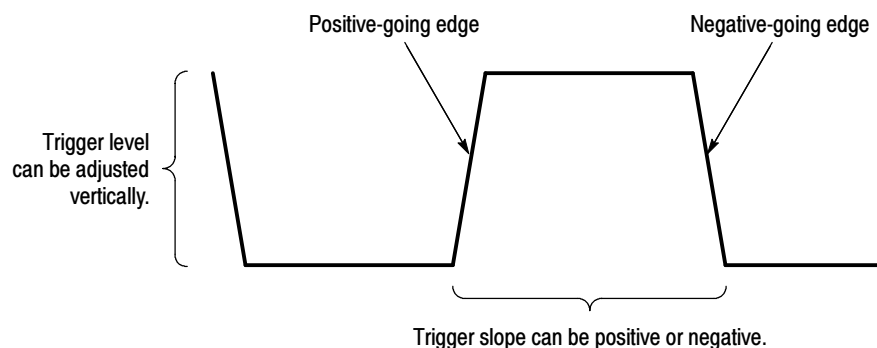

Figure 3-22: Slope and level controls help define the trigger

Delayed Trigger System

You can trigger with the A (Main) trigger system alone or you can combine the A (Main) trigger with the B (Delayed) trigger to trigger on sequential events. When using sequential triggering, the A trigger event arms the trigger system, and the B trigger event triggers the oscilloscope when the B trigger conditions are met. A and B triggers can (and typically do) have separate sources. The B trigger condition can be based on a time delay or a specified number of counted events. See *Sequential Triggering* on page 3-91 to learn how to use the delayed trigger system.

Triggering from the Front Panel

The front panel provides quick access to the most frequently used trigger controls. The trigger readout shows you the state of the trigger system.

The SLOPE, COUPLING, and SOURCE controls only work for edge triggering. To access the advanced trigger controls, open the Trigger Setup control window by pushing the ADVANCED button (See *Advanced Triggering* on page 3-62 for more information).

Setting up Triggers

Use this procedure to set up triggers using the front-panel controls.

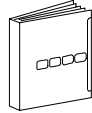
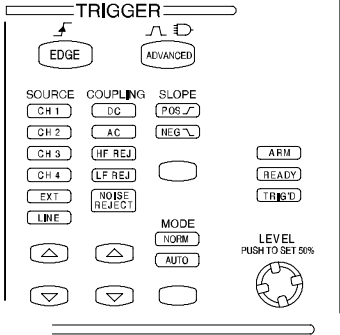
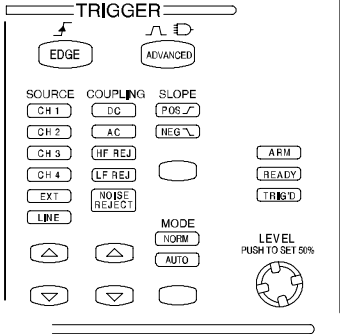
Overview	Triggering from the front panel	Control elements and resources
<p>Prerequisites</p>	<p>1. Set the acquisition system to RUN (the RUN/STOP control is lighted), and set the vertical and horizontal controls appropriately for the signal to be acquired.</p>	 <p>See page 3-21 for acquisition setup</p>
<p>Select the trigger type</p>	<p>2. Push the EDGE button to select edge triggering, or push ADVANCED to open the Trigger Setup control window to set up other trigger types.</p>	
<p>Select the trigger slope</p>	<p>3. Push the SLOPE button to toggle between POS and NEG:</p> <ul style="list-style-type: none"> ■ POS triggers on a rising edge (positive-going) signal ■ NEG triggers on a falling edge (negative-going) signal <p>You can also set the slope in the Trigger Setup control window.</p>	

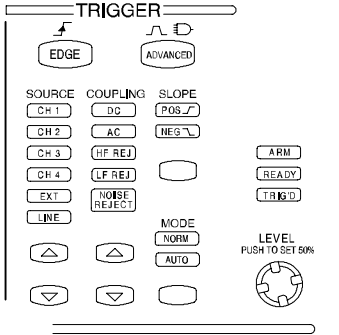
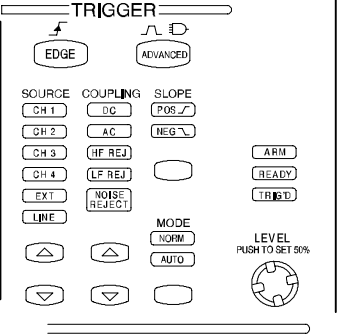
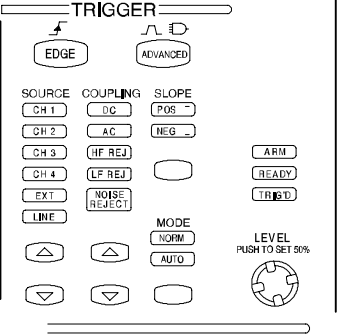
Overview	Triggering from the front panel	Control elements and resources
<p>Set the trigger level</p>	<p>4. To manually change the trigger level for edge triggers (or certain threshold levels for logic or pulse triggers), turn the LEVEL knob. You can also set the level in the Trigger Setup control window.</p>	 <p>The diagram shows the TRIGGER control panel with the following settings: SOURCE: CH 1, COUPLING: DC, SLOPE: POS, CH 2: AC, CH 3: HF REJ, CH 4: LF REJ, EXT: NOISE REJECT, LINE, MODE: NORM, and a LEVEL knob. The TRIGD button is also visible.</p>
<p>Set trigger level to 50%</p>	<p>5. To quickly set the edge trigger level to 50% of the waveform voltage range, push the LEVEL knob. The oscilloscope sets the trigger level to the halfway point between the peaks of the trigger signal. This function has no effect for the other trigger types.</p> <p>You can also click Set 50% in the Trigger Setup control window.</p>	 <p>The diagram is identical to the previous one, but the LEVEL knob is highlighted with a circle and labeled "LEVEL PUSH TO SET 50%".</p>
<p>Select the trigger source</p>	<p>6. Push the up and down arrow buttons to select a SOURCE:</p> <ul style="list-style-type: none"> ■ CH 1 through CH 4 are the input channels. The channel you select as a trigger source will function whether it is displayed or not. ■ EXT is a fifth, nondisplayable auxiliary (external) trigger source. To use the auxiliary trigger, connect the source to the front-panel AUX IN connector. ■ LINE is the AC line voltage. The oscilloscope is used to generate the trigger and you do not have to input a signal. The trigger level is fixed at zero volts. 	 <p>The diagram is identical to the previous ones, but the SOURCE buttons (CH 1, CH 2, CH 3, CH 4, EXT, LINE) are highlighted with a circle.</p>

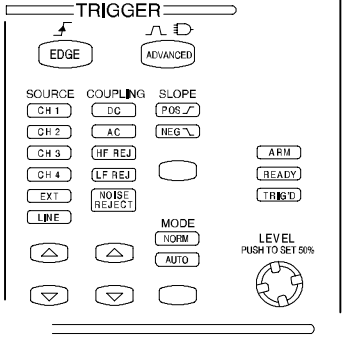
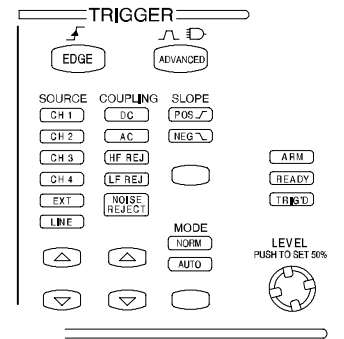
Overview	Triggering from the front panel	Control elements and resources
<p>Set the trigger coupling</p>	<p>7. Push the up and down arrow buttons to set COUPLING:</p> <ul style="list-style-type: none"> ■ DC passes both AC and DC components of the input signal. ■ AC passes only the AC components of an input signal. ■ HF REJ attenuates signals above 30 kHz. ■ LF REJ attenuates signals below 80 kHz. ■ NOISE REJECT provides lower sensitivity, reducing the chance of falsely triggering on noise. 	 <p>The diagram shows the TRIGGER control panel. At the top, there are two buttons: 'EDGE' (with a square wave icon) and 'ADVANCED' (with a square wave icon and a right-pointing arrow). Below these are three columns of controls: 'SOURCE' (CH 1, CH 2, CH 3, CH 4, EXT, LINE), 'COUPLING' (DC, AC, HF REJ, LF REJ, NOISE REJECT), and 'SLOPE' (POS, NEG, and a blank button). To the right of the COUPLING section are 'ARM', 'READY', and 'TRIGD' buttons. At the bottom, there are 'MODE' buttons for 'NORM' and 'AUTO', and a 'LEVEL' button with a circular icon and the text 'PUSH TO SET 50%'.</p>
<p>Select the trigger mode</p>	<p>8. Push the MODE button to toggle between NORM and AUTO trigger modes:</p> <ul style="list-style-type: none"> ■ NORM requires a valid trigger event to acquire a waveform. ■ AUTO acquires a waveform even if no valid trigger event occurs. <p>Be aware that in AUTO mode, the acquired waveforms may not be triggered.</p>	 <p>The diagram shows the TRIGGER control panel, identical to the one above. The 'MODE' section at the bottom now has 'NORM' and 'AUTO' buttons selected, indicating the trigger mode has been changed.</p>

Checking Trigger Status To see the state and setup of the triggering circuit, use the trigger status lights, readout, and screen.

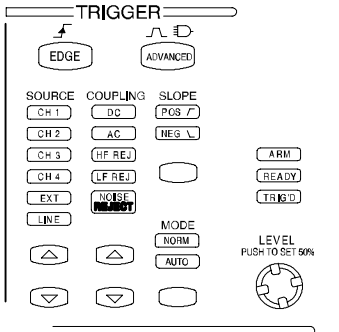
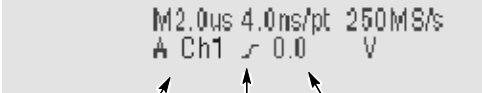
Overview	To check trigger status	Control elements and resources
<p>Trigger status from trigger status lights</p>	<p>1. To quickly determine the trigger status, check the ARM, READY, and TRIG'D controls.</p> <ul style="list-style-type: none"> ■ If TRIG'D is on, the oscilloscope has recognized a valid trigger and is filling the posttrigger portion of the waveform. ■ If READY is on, the oscilloscope can accept, and is waiting for, a valid trigger to occur. ■ If ARM is on, the trigger circuitry is filling the pretrigger portion of the waveform record. ■ If both TRIG'D and READY are on, a valid A event trigger has been recognized and the instrument is waiting for a delayed trigger. When a delayed trigger is recognized, the posttrigger portion of the delayed waveform will fill. ■ If ARM, TRIG'D, and READY are off, the acquisitions have stopped. 	 <p>The diagram shows the TRIGGER control panel with the following elements:</p> <ul style="list-style-type: none"> TRIGGER header with EDGE and ADVANCED modes. SOURCE controls: CH 1, CH 2, CH 3, CH 4, EXT, LINE. COUPLING controls: DC, AC, HF REJ, LF REJ, NOISE, IMBUST. SLOPE controls: POS ↑, NEG ↓. MODE controls: NORM, AUTO. LEVEL control: PUSH TO SET 50%. Status Lights: ARM, READY, TRIG'D.
<p>Trigger status from acquisition readout</p>	<p>2. To quickly determine the settings of some key trigger parameters, check the Trigger readout at the bottom of the display. The readouts differ for edge and the advanced triggers.</p>	 <p>The screenshot shows the following readout information:</p> <ul style="list-style-type: none"> Time base: M2.0us Trigger slope: 4.0ns/pt Trigger level: 250MS/s Trigger source: A Ch1 Trigger level value: 0.0 V <p>Annotations indicate: "A trigger source = Ch 1" and "Trigger slope = rising edge".</p>

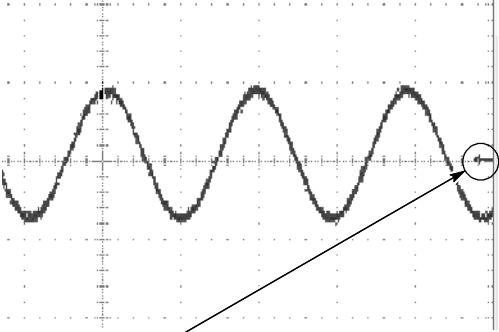
Overview	To check trigger status	Control elements and resources
<p>Trigger level on display</p>	<p>3. To see the trigger level on the waveform display, turn on a trigger level indicator (marker). See <i>Customizing the Waveform Display</i> on page 3-106 for instructions on setting the indicator.</p> <p>The trigger level indicator remains on the screen as long as the channel providing the trigger source is displayed. You can choose between two types of trigger level indicators: a horizontal bar or an arrow at the right side of the graticule.</p>	 <p>Trigger level indicator shows the trigger level on the waveform record. You can drag the indicator to set the trigger level.</p>



Additional Trigger Parameters

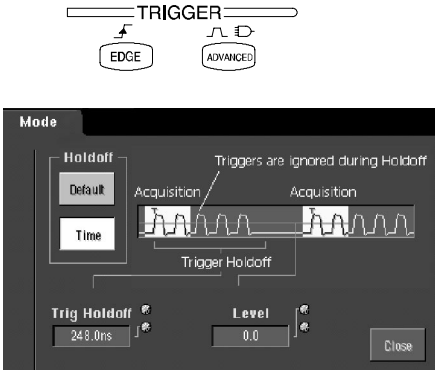

Some additional trigger parameters are accessible only through the Trigger Setup control window:

- Holdoff
- Trigger level presets
- Force trigger
- Single sequence

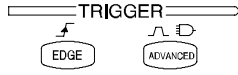
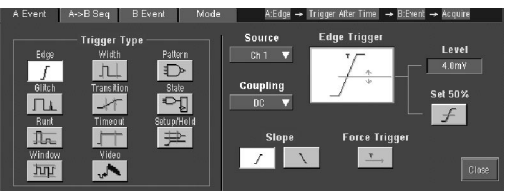
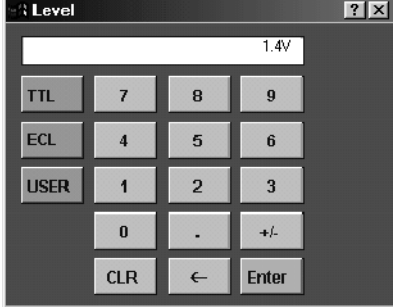
Use the procedures that follow to set up these additional trigger parameters. For more information, display online help while performing the procedure.

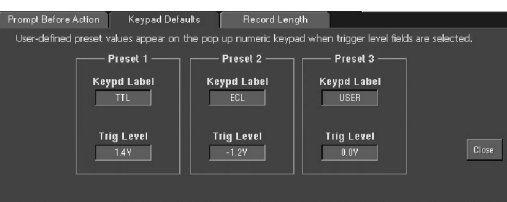
Overview	Additional trigger parameters	Control elements and resources
<p>Set holdoff</p>	<p>Change the holdoff time to help stabilize triggering (see <i>Trigger Holdoff</i> on page 3-52). To set holdoff:</p> <ol style="list-style-type: none"> 1. Push the front-panel ADVANCED button. 2. On the Trigger Setup control window, select the Mode tab. 3. Click Default or Time: <ul style="list-style-type: none"> ■ Default uses the oscilloscope default holdoff time, which is five times the current horizontal scale setting. Default maintains a good value for general purpose triggering. ■ Time enables you to enter a holdoff that may allow more stable triggering. This time is used at all horizontal scale settings. 4. If using Time, click Trig Holdoff and enter the time value using the multipurpose knob. The holdoff range is 1.5 μs to 12 seconds. 	

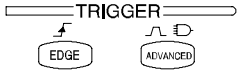
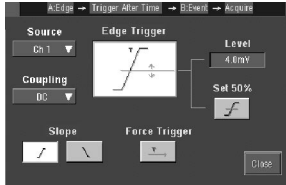
Overview	Additional trigger parameters	Control elements and resources
<p>Select a preset trigger level</p>	<ol style="list-style-type: none"> 5. Push the front-panel ADVANCED button. 6. On the Trigger Setup control window, select the A Event tab. 7. Click a Trigger Type button to select a trigger, such as Edge, that uses a level adjustment. A trigger uses a level adjustment if the Level control appears on the right side of the screen with the trigger type setup controls. 8. Click on Level and click on the keypad icon to open the keypad. Click on either TTL, ECL, or USER: <ul style="list-style-type: none"> ■ TTL fixes the trigger level at +1.4 V. ■ ECL fixes the trigger level at -1.3 V. ■ USER fixes the trigger level at a user preset voltage (see Steps 9 through 12). <p>When you set the volts/div smaller than 200 mV, the oscilloscope reduces the TTL or ECL trigger levels below standard TTL and ECL levels. This reduction occurs because the trigger level range is fixed at ± 12 divisions from the center. At 100 mV (the next smaller setting after 200 mV) the trigger range is ± 1.2 V, which is smaller than the typical TTL (+1.4 V) or ECL (-1.3 V) level.</p> 	  
<p>Define new trigger level presets</p>	<ol style="list-style-type: none"> 9. If the menu bar is not displayed, click the Menu toolbar button. 10. Select the Utilities menu User Preferences option. The User Preferences control window opens. 11. Select the Keypad Defaults tab. 12. Click on the appropriate Trig Level and adjust the preset using the multipurpose knob or pop-up keypad. 13. If desired, click on a Keypad Label and change the label of the preset using the pop-up keyboard. 	 

Overview	Additional trigger parameters	Control elements and resources
<p>Force a trigger</p>	<p>14. Push the front-panel ADVANCED button.</p> <p>15. On the Trigger Setup control window, select the A Event or B Event tab</p> <p>16. Click Edge.</p> <p>17. To force the oscilloscope to immediately acquire one waveform record, even without a trigger event, click Force Trigger.</p> <p>Forcing a trigger is useful when, in normal trigger mode, the input signal is not supplying a valid trigger. Click Force Trigger to quickly confirm that there is a signal present for the oscilloscope to acquire. Then determine how to trigger on the signal (for example, push LEVEL to set 50%, check the trigger source setting, and so on).</p> <p>The oscilloscope acts on Force Trigger even if selected before the end of pretrigger holdoff. However, the button has no effect if the acquisition system is stopped.</p>	 
<p>Single sequence triggering</p>	<p>18. To trigger on the next valid trigger event and then stop, push the front-panel SINGLE button.</p> <p>19. To leave single sequence mode, push the front-panel RUN/STOP button.</p> <p>The exact function of the SINGLE button depends on the acquisition mode. In Sample, Peak Detect, or Hi Res acquisition modes, acquisition stops after a single waveform is acquired. In Average or Envelope modes, acquisition stops after N waveforms are acquired, where N is the number of averages or envelopes specified.</p> <p>Single sequence triggering is not available in Fast Acquisition mode.</p>	

Advanced Triggering

This section describes how to use the advanced triggers: *glitch*, *runt*, *width*, *transition* (slew rate), *pattern*, *state*, *setup/hold*, *window*, *video*, and *timeout*.

You can check the advanced trigger status in the readout. The readout indicates the trigger type and then shows sources, levels, or any other parameters that are important for the particular trigger type. Figure 3-23 shows an example readout for the state trigger type.

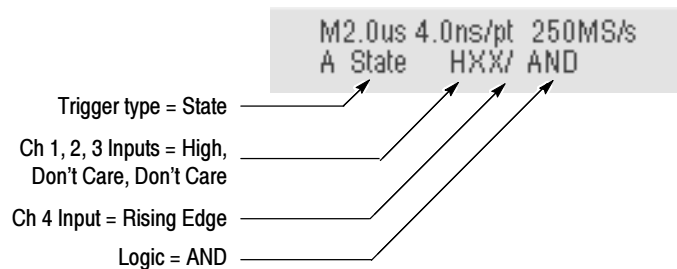

Figure 3-23: Example advanced trigger readout

Each advanced trigger is described below.

Glitch Trigger. A glitch trigger occurs when the oscilloscope detects a pulse narrower (or wider) than some specified time. You can set the oscilloscope to trigger on glitches of either polarity, or to reject glitches of either polarity.

Runt Trigger. A runt trigger occurs when the oscilloscope detects a short pulse that crosses one threshold but fails to cross a second threshold before recrossing the first. You can set the oscilloscope to detect any positive or negative runt pulse, or only those wider than a specified minimum width. Runt pulses can also be qualified by the logical state of other channels.

Width Trigger. A width trigger occurs when the oscilloscope detects a pulse that is inside or outside some specified time range. The oscilloscope can trigger on positive or negative width pulses.

Transition Time Trigger. Transition triggering is based on the slope (change in voltage/change in time) of a pulse edge. Use the transition trigger to trigger the oscilloscope on pulse edges that traverse between two thresholds at faster or slower rates than the specified time. You can set up the oscilloscope to trigger on positive or negative edges.

Timeout Trigger. A timeout trigger occurs when the oscilloscope does *not* detect an expected pulse transition. If the pulse transition occurs prior to a specified timeout time (the expected case), then no trigger results.

Pattern Trigger. A pattern trigger occurs when the inputs to the selected logic function cause the function to become True or False. When you use a pattern trigger, you define:

- The precondition for each logic input: logic high, low, or “don’t care”; the logic inputs are the oscilloscope channels
- The Boolean logic function: AND, NAND, OR, or NOR
- The condition for triggering: the Boolean function becomes True (logic high) or False (logic low), and whether the True condition is time qualified









Pattern trigger logic choices are summarized in Table 3-5.

State Trigger. A state trigger occurs when the inputs to the logic function cause the function to become True or False at the time the clock input changes state. When you use a state trigger, you define:

- The precondition for logic input channels 1 through 3 (channel 1 on TDS5052)
- The direction of the state change for the clock input, channel 4 (channel 2 on the TDS5052)
- The Boolean logic function: AND, NAND, OR, or NOR (not available on the TDS5052)
- The condition for triggering: the Boolean function becomes True (logic high) or False (logic low)

State trigger logic conditions are summarized in Table 3-5.

Table 3-5: Pattern and state logic

Pattern	State	Definition ^{1, 2}
 AND	 Clocked AND	If <i>all</i> the preconditions selected for the logic inputs ³ are TRUE, then the oscilloscope triggers.
 NAND	 Clocked NAND	If <i>not all</i> of the preconditions selected for the logic inputs ³ are TRUE, then the oscilloscope triggers.
 OR	 Clocked OR	If <i>any</i> of the preconditions selected for the logic inputs ³ are TRUE, then the oscilloscope triggers.
 NOR	 Clocked NOR	If <i>none</i> of the preconditions selected for the logic inputs ³ are TRUE, then the oscilloscope triggers.

- ¹ For state triggers, the definition must be met at the time the clock input changes state.
- ² The definitions given here are correct for the Goes TRUE setting in the Trigger When menu. If that menu is set to Goes False, swap the definition for AND with that for NAND and for OR with NOR for both pattern and state types.
- ³ The logic inputs are channels 1, 2, 3, and 4 when using Pattern triggers. For State triggers, channel 4 becomes the clock input, leaving the remaining channels as logic inputs. (On the TDS5052, channel 2 is the clock input.)

Setup/Hold Trigger. A setup/hold trigger occurs when a logic input changes state inside of the setup and hold times relative to the clock. When you use setup/hold triggering, you define:

- The channel containing the logic input (the data source) and the channel containing the clock (the clock source)
- The direction of the clock edge to use
- The clocking level and data level that the oscilloscope uses to determine if a clock or data transition has occurred
- The setup and hold times that together define a time range relative to the clock

Data that changes state within the setup/hold violation zone triggers the oscilloscope. Figure 3-24 shows how the setup and hold times you choose position this zone relative to the clock.

Setup/hold triggering uses the setup/hold violation zone to detect when data is unstable too near the time it is clocked. Each time trigger holdoff ends, the oscilloscope monitors the data and clock sources. When a clock edge occurs, the oscilloscope checks the data stream it is processing (from the data source) for transitions occurring within the setup/hold violation zone. If any occur, the oscilloscope triggers with the trigger point located at the clock edge.

Positive settings for both setup and hold times (the most common application) locate the setup/hold violation zone so it spans the clocking edge. (See the top waveform in Figure 3-24.) The oscilloscope detects and triggers on data that does not become stable long enough before the clock (setup time violation) or that does not stay stable long enough after the clock (hold time violation).

Negative settings for setup or hold times skew the setup/hold violation zone to locate it before or after the clocking edge. (See the bottom and center waveforms of Figure 3-24.) The oscilloscope can then detect and trigger on violations of a time *range* that occurs before or one that occurs after the clock.

NOTE. Keep the hold-time setting to no more than 2.5 ns less than one-half the clock period ($\text{hold time} \leq (\text{period}/2) - 2.5 \text{ ns}$) or the oscilloscope cannot trigger (this assumes a 50% duty cycle clock).

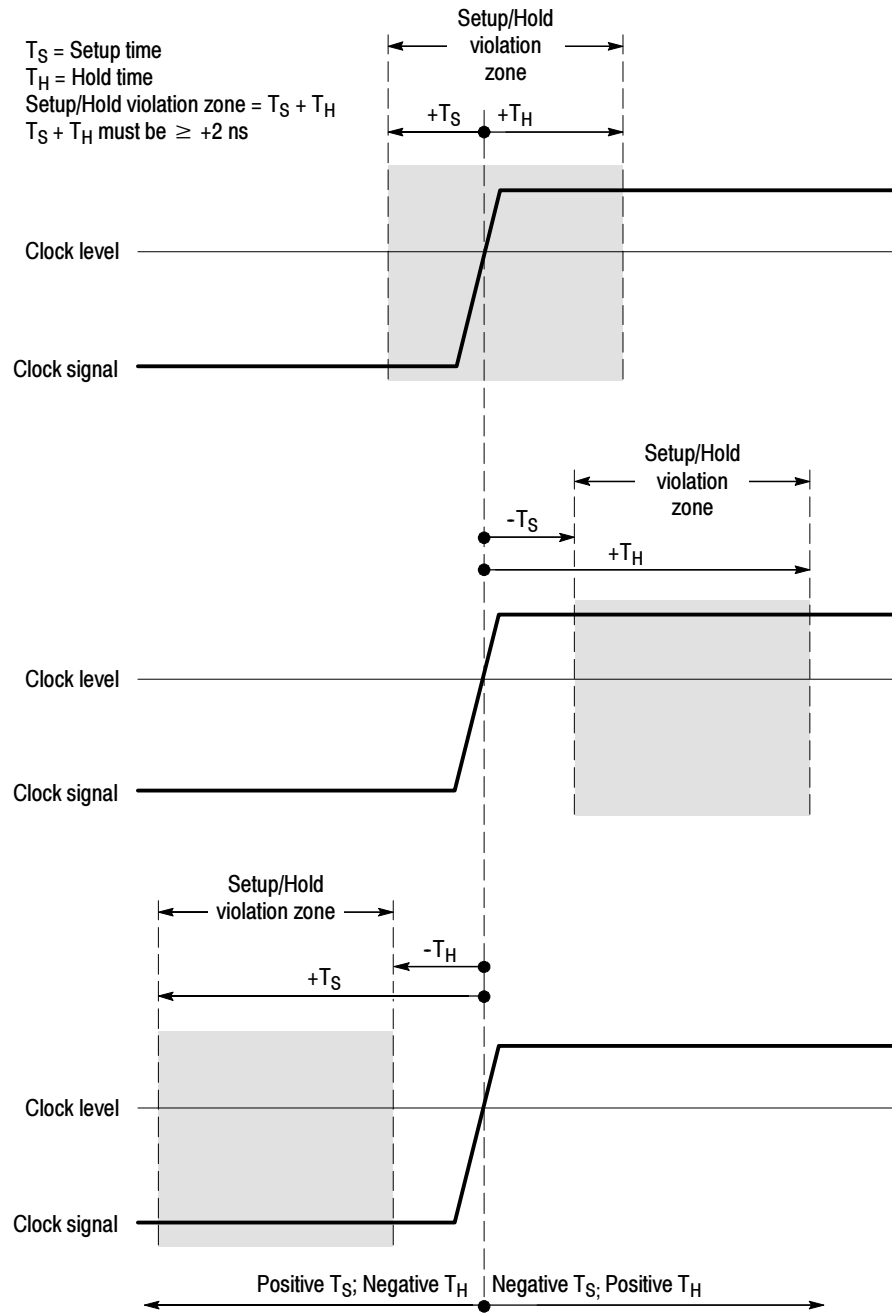
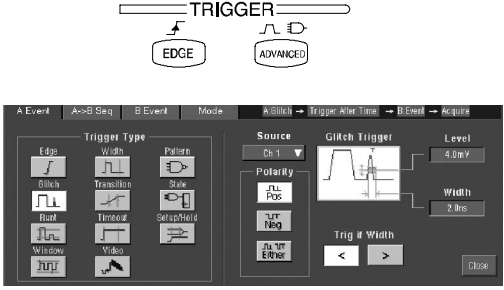
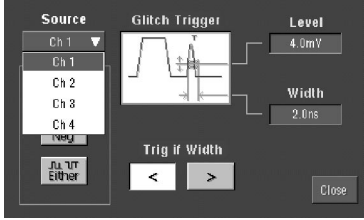
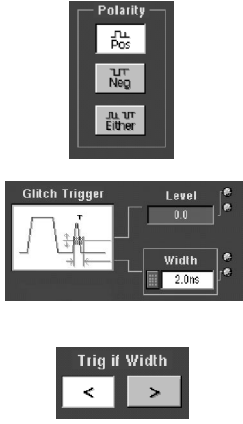
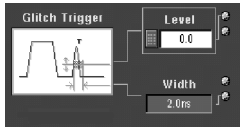

Figure 3-24: Violation zones for Setup/Hold triggering

Window Trigger. Use the Window trigger to trigger the oscilloscope when the input signal rises above an upper threshold level or falls below a lower threshold level. After setting these levels, you can specify whether you want to trigger the instrument as the signal is entering or leaving the threshold window. You can further qualify the trigger event in terms of time, or by the logical state of other channels.

Video Trigger. Use the Video trigger to trigger the oscilloscope on specified fields or lines of a composite video signal. Select from several preset video signal formats or set a custom format. Only composite signal formats are supported. Graphic display formats such as RGB and VGA are not supported.

Triggering on a Glitch Use this procedure to detect and trigger on a glitch or to ignore a glitch.

Overview	To trigger on a glitch	Control elements and resources
<p>Select glitch triggering</p>	<ol style="list-style-type: none"> 1. Push the front-panel ADVANCED button. 2. On the Trigger Setup control window, select the A Event tab. 3. Click Glitch. 	
<p>Select the source</p>	<ol style="list-style-type: none"> 4. To specify which channel becomes the trigger source, click Source, and select the source from the list. 	
<p>Select the polarity and width</p>	<ol style="list-style-type: none"> 5. Click a Polarity button to specify the glitch polarity: <ul style="list-style-type: none"> ■ Pos looks at positive-going pulses. ■ Neg looks at negative-going pulses. ■ Either looks at both positive and negative pulses. 6. To specify the width of the glitch, click Width and set the glitch width using the multipurpose knob or keypad. 7. To specify whether to trigger on glitches narrower or greater than the width you specify, click: <ul style="list-style-type: none"> ■ Trig if Width < to trigger only on narrower pulses. ■ Trig if Width > to trigger only on wider pulses. 	
<p>Set the level</p>	<ol style="list-style-type: none"> 8. Click Glitch Trigger Level and use the multipurpose knobs, keypad, or front-panel LEVEL knob to set the level that the glitch must cross to be recognized by the oscilloscope. <p>You can set the level to a value appropriate to either the TTL or ECL logic families by clicking TTL or ECL on the Level pop-up keypad.</p>	

Overview	To trigger on a glitch	Control elements and resources
<p>Set mode and holdoff</p>	<p>9. Mode and holdoff can be set for all standard trigger types. Refer to <i>Select the trigger mode</i> on page 3-56 and <i>Set holdoff</i> on page 3-59. To learn more about trigger mode and holdoff, see <i>Trigger Modes</i> on page 3-51 and <i>Trigger Holdoff</i> on page 3-52.</p>	<div data-bbox="1209 367 1295 478" data-label="Image"> </div> <p>For mode and holdoff setup, see <i>Select the trigger mode</i> on page 3-56 and <i>Set holdoff</i> on page 3-59.</p>

Triggering on a Runt Pulse

Use this procedure to detect and trigger on a runt pulse. The oscilloscope can look for positive or negative runt pulses. These pulses can also be qualified by time or by the logical state of other channels. - -

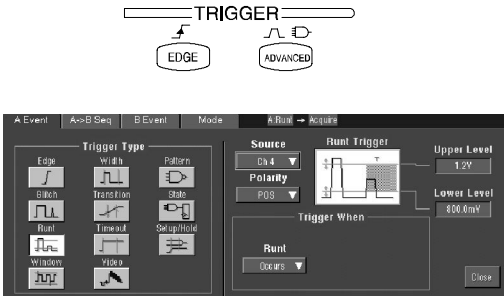
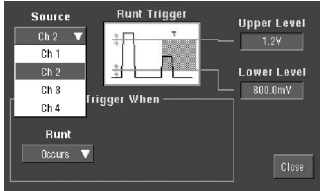

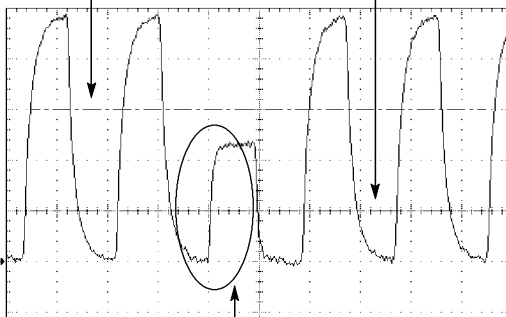
Overview	To trigger on a runt pulse	Control elements and resources
<p>Select runt triggering</p>	<ol style="list-style-type: none"> 1. Push the front-panel ADVANCED button. 2. On the Trigger Setup control window, select the A Event tab. 3. Click Runt. 	 <p>The diagram shows a 'TRIGGER' section with two buttons: 'EDGE' and 'ADVANCED'. Below it is a screenshot of the oscilloscope's Trigger Setup window. The 'A Event' tab is selected. In the 'Trigger Type' menu, 'Runt' is highlighted. The 'Source' is set to 'Ch 4', 'Polarity' is 'POS', and 'Trigger When' is set to 'Occurs'. The 'Upper Level' is 1.2V and the 'Lower Level' is 800.0mV.</p>
<p>Select the source</p>	<ol style="list-style-type: none"> 4. To specify which channel becomes the pulse trigger source, click Source and select the source from the list. 	 <p>The screenshot shows the 'Source' dropdown menu open, listing 'Ch 1', 'Ch 2', 'Ch 3', and 'Ch 4'. The 'Runt' trigger type is still selected, and the 'Trigger When' is set to 'Occurs'. The 'Upper Level' is 1.2V and the 'Lower Level' is 800.0mV.</p>

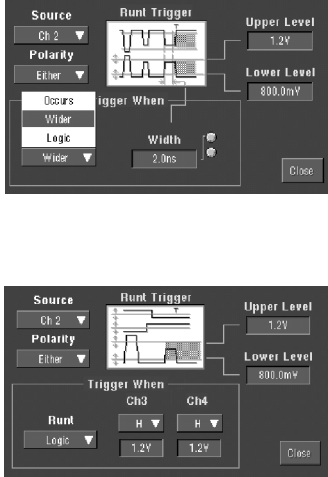
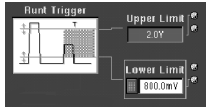
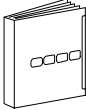
Overview	To trigger on a runt pulse	Control elements and resources
<p>Select the polarity</p>	<p>5. Select a Polarity value to specify the direction of the runt pulse. Triggering occurs at the point the pulse returns over the first (lower) threshold going negative without crossing the second threshold level (upper). The polarity selected in the Polarity window determines the order that the threshold must be crossed for a runt trigger to occur:</p> <ul style="list-style-type: none"> ■ Pos looks at positive-going pulses. The lower threshold must be first crossed going positive, then recrossed going negative without the upper threshold being crossed at all. ■ Neg looks at negative-going pulses. The upper threshold must be first crossed going negative, then recrossed going positive without the lower threshold being crossed at all. ■ Either looks at both positive and negative pulses. Either one of the thresholds must be first crossed going in either direction, then recrossed going in the opposite direction without the other threshold being crossed at all. <p>For all three polarity settings, triggering occurs at the point the runt pulse recrosses its first threshold.</p>	<div data-bbox="1047 367 1377 556" style="border: 1px solid black; padding: 5px;"> <p>Source: Ch 2</p> <p>Polarity: Either</p> <p>Trigger When: POS, NEG, Either</p> <p>Upper Level: 1.2V</p> <p>Lower Level: 800.0mV</p> <p>Occurs: [dropdown]</p> <p>Close</p> </div> <div style="text-align: center; margin-top: 10px;"> <p>Selected trigger bar at upper threshold. Unselected trigger bar at lower threshold.</p>  <p>Runt pulse crosses first threshold only, recrosses first threshold level, and triggers acquisition</p> </div>

Overview	To trigger on a runt pulse	Control elements and resources
<p>Qualify the runt trigger</p>	<p>6. To qualify the runt pulse trigger, click Trigger When Runt and select from the list:</p> <ul style="list-style-type: none"> ■ Occurs triggers on all runt pulses regardless of width. ■ Wider triggers only on runt pulses that exceed the minimum width you set. Enter the Width using the multipurpose knob or pop-up keypad. ■ Logic triggers on a logic-qualified runt pulse. When the oscilloscope detects that a runt has occurred, it checks the logical state of two other available channels and triggers only if their conditions are met. Each channel can have a value of high (H), low (L), or “don’t care” (X). A value is considered high if the channel input voltage is greater than the specified threshold voltage; a value is considered low if the channel input voltage is less than the specified threshold voltage. Use the “don’t care” selection for any channels that will not be used as part of the pattern. (Only available on the TDS5054 and TDS5104 models.) 	
<p>Set the thresholds</p>	<p>7. To set the threshold levels, click Upper Limit or Lower Limit and use the multipurpose knobs or pop-up keypad to set the values.</p> <p>Hint: To use the trigger level marker to set the threshold levels, open the Display Setup control window and click Long on the Objects tab.</p>	
<p>Set mode and holdoff</p>	<p>8. Mode and holdoff can be set for all standard trigger types. Refer to <i>Select the trigger mode</i> on page 3-56 and <i>Set holdoff</i> on page 3-59. To learn more about trigger mode and holdoff, see <i>Trigger Modes</i> on page 3-51 and <i>Trigger Holdoff</i> on page 3-52.</p>	 <p>For mode and holdoff setup, see <i>Select the trigger mode</i> on page 3-56 and <i>Set holdoff</i> on page 3-59.</p>

Triggering on the Pulse Width

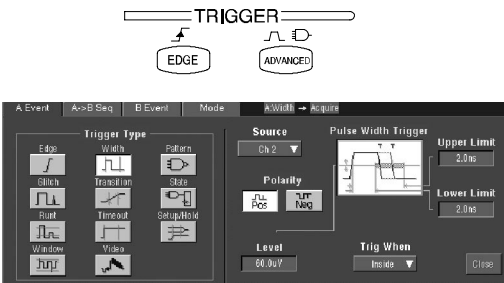
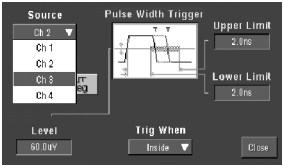
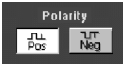

Use this procedure to detect and trigger on a pulse that is either wider or narrower than the specified range.

Overview	To trigger based on pulse width	Control elements and resources
<p>Select width triggering</p>	<ol style="list-style-type: none"> 1. Push the front-panel ADVANCED button. 2. On the Trigger Setup control window, select the A Event tab. 3. Click Width. 	
<p>Select the source</p>	<ol style="list-style-type: none"> 4. To specify which channel becomes the trigger source, click Source and select the source from the list. 	
<p>Select the polarity</p>	<ol style="list-style-type: none"> 5. To specify the polarity of the pulse, click Pos (for positive-going pulses) or Neg (for negative-going pulses). 	
<p>Set the range</p>	<ol style="list-style-type: none"> 6. To set the range of pulse widths in units of time, click Upper or Lower Limit and enter the values with the multipurpose knobs or pop-up keypad: <ul style="list-style-type: none"> ■ Upper Limit is the maximum valid pulse width the trigger source will look for. ■ Lower Limit is the minimum valid pulse width. The oscilloscope will always force the Lower Limit to be less than or equal to the Upper Limit. 7. Click Trigger When and select Inside to trigger on pulses that fall within the specified range, or Outside to trigger on pulses that are outside the range. 	
<p>Set the level</p>	<ol style="list-style-type: none"> 8. Click Level and use the multipurpose knob or pop-up keypad to set the trigger level. 	

Overview	To trigger based on pulse width	Control elements and resources
<p>Set mode and holdoff</p>	<p>9. Mode and holdoff can be set for all standard trigger types. Refer to <i>Select the trigger mode</i> on page 3-56 and <i>Set holdoff</i> on page 3-59. To learn more about trigger mode and holdoff, see <i>Trigger Modes</i> on page 3-51 and <i>Trigger Holdoff</i> on page 3-52.</p>	<div data-bbox="1149 373 1235 485" data-label="Image"> </div> <p>For mode and holdoff setup, see <i>Select the trigger mode</i> on page 3-56 and <i>Set holdoff</i> on page 3-59.</p>

Triggering on Transition Time

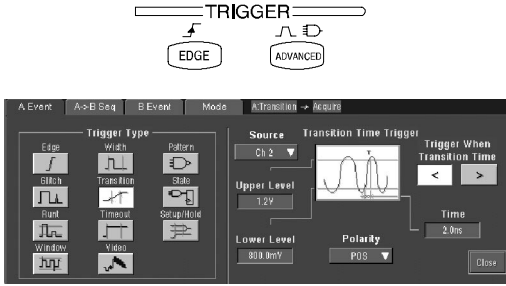
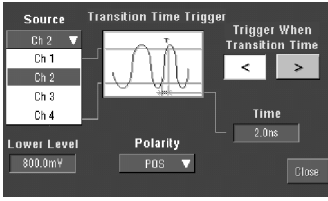

Use this procedure to detect and trigger on pulse edges that traverse between two thresholds at faster or slower rates than the specified time. You can set up the oscilloscope to trigger on positive or negative edges.

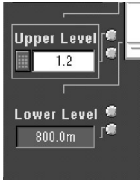
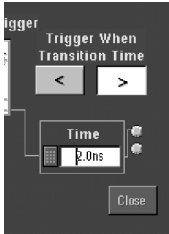
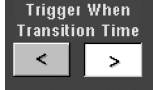
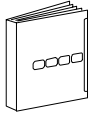
Overview	To trigger on transition time	Control elements and resources
<p>Select transition triggering</p>	<ol style="list-style-type: none"> 1. Push the front-panel ADVANCED button. 2. In the Trigger Setup control window, select the A Event tab. 3. Click Transition. 	
<p>Select the source</p>	<ol style="list-style-type: none"> 4. To specify which channel becomes the trigger source, click Source and select the source from the list. 	
<p>Select the polarity</p>	<ol style="list-style-type: none"> 5. Select a Polarity value to specify the direction of the pulse edge: <ul style="list-style-type: none"> ■ Pos monitors the transition time (slew rate) of the positive-going edges of pulses. The edge must first cross the lower threshold and then cross the upper threshold. ■ Neg monitors the transition time (slew rate) of the negative-going edges of pulses. The edge must first cross the upper threshold and then cross the lower threshold. ■ Either monitors positive- and negative-going edges of pulses. The edge may first cross either threshold and then cross the other. 	

Overview	To trigger on transition time	Control elements and resources
<p>Set the transition time</p>	<p>6. The threshold levels and the delta time setting determine the transition time (slew rate) setting. The level settings determine the voltage component of slew rate (Volts/Second). Click the Upper Level or Lower Level button and use the multipurpose knobs or pop-up keypad to set the values for the upper and lower levels.</p> <p>You can set the level(s) to a value appropriate to either the TTL or ECL logic families by clicking TTL or ECL on the Level pop-up keypad.</p> <p>Hint: To use the trigger level marker to set the threshold levels, open the Display Setup control window, and click Long on the Objects tab.</p> <p>7. To finish specifying the slew rate (transition time), set the time component by clicking Time and using the multipurpose knob or keypad to set the delta time value.</p> <p>8. Click Trigger When Transition Time < to trigger when the transition time is less than the time you set above. Click Trigger When Transition Time > to trigger when the transition time is greater than the time you set above.</p> <p>If you select Trigger When Transition Time > (greater than) and the oscilloscope does not trigger, the pulse edge may be too fast. To check the pulse edge speed, switch to edge triggering. Trigger on the pulse edge and determine the time the edge takes to travel between the upper and lower levels that you set for this trigger. The oscilloscope cannot transition trigger on pulse edges that traverse between threshold levels in 600 ps or less.</p> <p>Also, to reliably trigger on transition time, a pulse must have a width of 7.5 ns or more. A pulse of less width may trigger on the wrong slope or not trigger at all. Switch to edge triggering and check the pulse width if you can't trigger on transition time as expected.</p>	  
<p>Set mode and holdoff</p>	<p>9. Mode and holdoff can be set for all standard trigger types. Refer to <i>Select the trigger mode</i> on page 3-56 and <i>Set holdoff</i> on page 3-59. To learn more about trigger mode and holdoff, see <i>Trigger Modes</i> on page 3-51 and <i>Trigger Holdoff</i> on page 3-52.</p>	 <p>For mode and holdoff setup, see <i>Select the trigger mode</i> on page 3-56 and <i>Set holdoff</i> on page 3-59.</p>

Triggering on Pulse Timeout

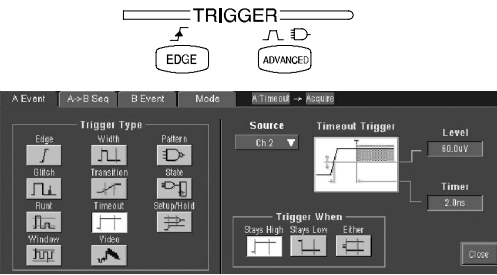
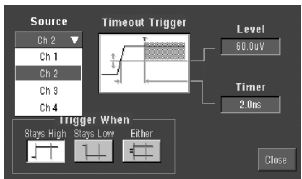
Use this procedure to detect and trigger on pulses longer than a specified time. The oscilloscope will trigger at the end of the timeout period.

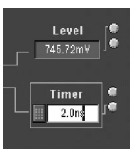
Overview	To trigger on pulse timeout	Control elements and resources
<p>Select timeout triggering</p>	<ol style="list-style-type: none"> 1. Push the front-panel ADVANCED button. 2. On the Trigger Setup control window, select the A Event tab. 3. Click Timeout. 	
<p>Select the source</p>	<ol style="list-style-type: none"> 4. To specify which channel becomes the trigger source, click Source and select the source from the list. 	
<p>Set the level</p>	<ol style="list-style-type: none"> 5. To set the trigger timeout level, click Level and use the multipurpose knobs or pop-up keypad to enter the voltage level. You can set the level to a value appropriate to either the TTL or ECL logic families by clicking TTL or ECL on the Level pop-up keypad. 	
<p>Set the timer</p>	<ol style="list-style-type: none"> 6. To set the timeout timer, click Timer and use the multipurpose knob or pop-up keyboard to set the time. 	

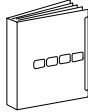
Overview	To trigger on pulse timeout	Control elements and resources
<p>Set the pulse threshold</p>	<p>7. To set the pulse threshold, click:</p> <ul style="list-style-type: none"> ■ Stay High to trigger if the signal stays higher than the trigger level for longer than the timeout (Timer) value. ■ Stay Low to trigger if the signal stays lower than the trigger level for longer than the timeout (Timer) value. ■ Either to trigger if the signal stays lower or stays higher than the trigger level for longer than the timeout (Timer) value. 	
<p>Set mode and holdoff</p>	<p>8. Mode and holdoff can be set for all standard trigger types. Refer to <i>Select the trigger mode</i> on page 3-56 and <i>Set holdoff</i> on page 3-59. To learn more about trigger mode and holdoff, see <i>Trigger Modes</i> on page 3-51 and <i>Trigger Holdoff</i> on page 3-52.</p>	 <p>For mode and holdoff setup, see <i>Select the trigger mode</i> on page 3-56 and <i>Set holdoff</i> on page 3-59.</p>

Triggering on a Pattern

Use this procedure to trigger the oscilloscope when the logic inputs cause the selected function to become True or False. You can also specify that the logic conditions must be satisfied for a specific amount of time before the oscilloscope triggers.

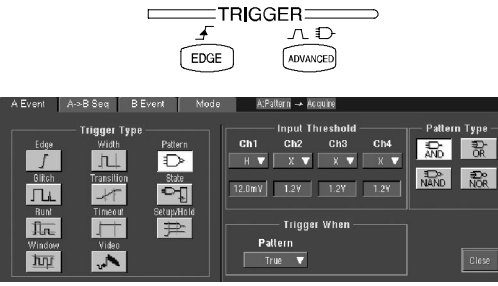
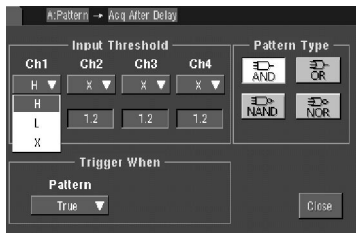
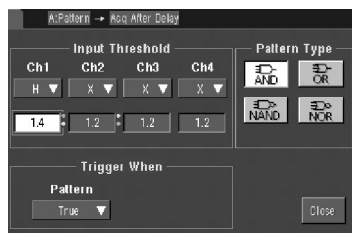
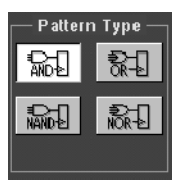
Overview	To trigger on a pattern	Control elements and resources
<p>Select pattern triggering</p>	<ol style="list-style-type: none"> 1. Push the front-panel ADVANCED button. 2. On the Trigger Setup control window, select the A Event tab. 3. Click Pattern. 	
<p>Define pattern inputs</p>	<ol style="list-style-type: none"> 4. Select an input value from the drop-down list for each channel. The channel inputs combine to form a logic pattern. Each channel can have a value of high (H), low (L), or "don't care" (X). A value is considered high if the channel input voltage is greater than the specified threshold voltage; a value is considered low if the channel input voltage is less than the specified threshold voltage. Use the "don't care" selection for any channels that will not be used as part of the pattern. 	
<p>Set threshold voltages</p>	<ol style="list-style-type: none"> 5. To set the threshold voltages, click on the channel threshold control and use the multipurpose knobs or pop-up keypad to set each threshold. 	
<p>Select logic pattern</p>	<ol style="list-style-type: none"> 6. Select the Boolean logic function for the combination of input channels. The oscilloscope will trigger on a clock edge when the input waveforms match the specified logic pattern. <p>See page 3-64 for definitions of the logic functions for pattern triggers.</p>	

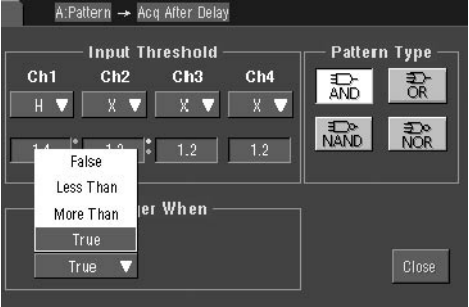
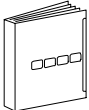
Overview	To trigger on a pattern	Control elements and resources
<p>Set trigger criteria</p>	<p>7. From the Trigger When Pattern list, select True to trigger the oscilloscope when the logic patterns are true. Select False to trigger the oscilloscope when the logic patterns are false.</p> <p>The list items More Than and Less Than are used to time qualify a pattern trigger. See Step 9 for instructions.</p>	
<p>Set mode and holdoff</p>	<p>8. Mode and holdoff can be set for all standard trigger types. Refer to <i>Select the trigger mode</i> on page 3-56 and <i>Set holdoff</i> on page 3-59. To learn more about trigger mode and holdoff, see <i>Trigger Modes</i> on page 3-51 and <i>Trigger Holdoff</i> on page 3-52.</p>	 <p>For mode and holdoff setup, see <i>Select the trigger mode</i> on page 3-56 and <i>Set holdoff</i> on page 3-59.</p>

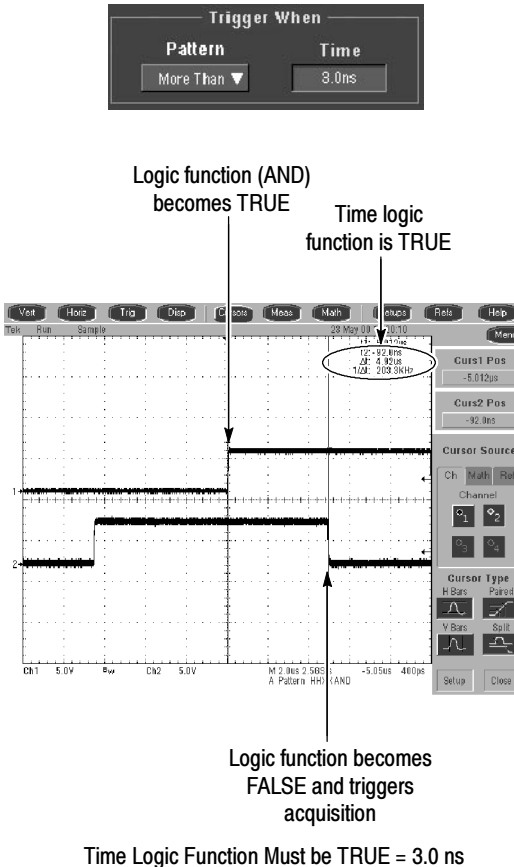
Overview	To trigger on a pattern	Control elements and resources
<p>To define a time qualified pattern trigger</p>	<p>9. You can time qualify a pattern logic trigger, that is, you can specify the amount of time that the Boolean logic function must be True. You must select Less than or More Than for the Trigger When Pattern control. Then, click on Trigger When Time and set the time using the multipurpose knob or keypad.</p> <p>When you select Less Than and specify a time, the input conditions must drive the logic function True for less than the specified time. Conversely, the True for More Than item requires the Boolean function to be True for longer than the time you specify.</p> <p>The oscilloscope determines the trigger point in the following manner:</p> <ul style="list-style-type: none"> ■ It waits for the logic condition to become True. ■ It starts timing and waits for the logic function to become False. ■ It compares the times and, if the time True is longer (More Than Time) or shorter (Less Than Time), then it triggers a waveform display at the point the logic condition became False. This time can be, and usually is, different from the time set. <p>In the figure, the delay between the vertical bar cursors is the time the logic function is True. Since this time is more (4.9 ns) than the More Than Time (3.0 ns), the oscilloscope issues the trigger at that point, not at the point at which it has been True for 3.0 ns.</p>	 <p>The figure illustrates the trigger logic. A dialog box titled "Trigger When" shows "Pattern" set to "More Than" and "Time" set to "3.0ns". Below, an oscilloscope waveform shows two signals. A vertical cursor is at the start of the logic function being True, and another is at the end. A measurement box shows "Time = 4.9ns". Text annotations explain that because the logic function was True for 4.9ns (longer than the 3.0ns set time), the trigger occurs at the point it becomes False. A caption reads "Time Logic Function Must be TRUE = 3.0 ns".</p>

Triggering on Logic State Use this procedure to trigger the oscilloscope when all of the logic inputs to the selected logic function cause the function to be True or False when the clock (channel 4) input changes state. (The clock input is channel 2 on the TDS5052.)

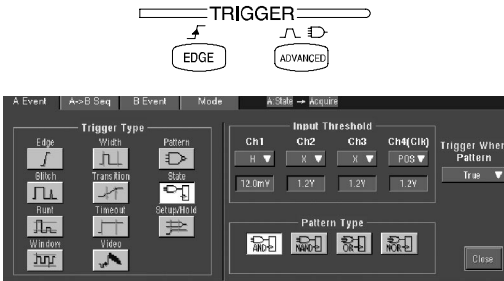
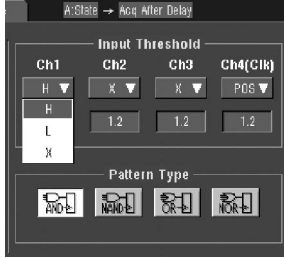
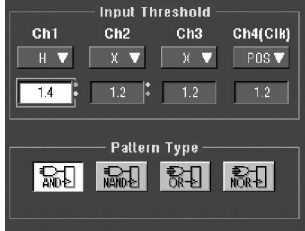

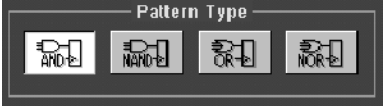
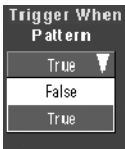
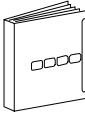
Overview	To trigger on state	Control elements and resources																				
<p>Select state triggering</p>	<ol style="list-style-type: none"> 1. Push the front-panel ADVANCED button. 2. On the Trigger Setup control window, select the A Event tab. 3. Click State. 	 <p>The diagram shows a 'TRIGGER' menu with 'EDGE' and 'ADVANCED' options. Below it is a screenshot of the 'Trigger Setup' window. The 'A Event' tab is selected, and the 'State' option is chosen under the 'Trigger Type' section. The 'Input Threshold' section shows Ch1 (H), Ch2 (X), Ch3 (X), and Ch4 (Clk) (POS). The 'Pattern Type' section shows AND, NAND, OR, and NOR options.</p>																				
<p>Define state inputs</p>	<ol style="list-style-type: none"> 4. Select an input value from the drop-down list for each channel. Channels 1, 2, and 3 represent the data inputs (Channel 1 only on the TDS5052). Channel 4 (Channel 2 on the TDS5052) should be connected to the clock signal. <p>The channel inputs combine to form a logic pattern. Each channel can have a value of high (H), low (L), or "don't care" (X). A value is considered high if the channel input voltage is greater than the specified threshold voltage; a value is considered low if the channel input voltage is less than the specified threshold voltage. Use the "don't care" selection for any channels that will not be used as part of the pattern.</p>	 <p>The screenshot shows the 'Input Threshold' window. It has a table for channel settings:</p> <table border="1"> <thead> <tr> <th>Ch1</th> <th>Ch2</th> <th>Ch3</th> <th>Ch4 (Clk)</th> </tr> </thead> <tbody> <tr> <td>H</td> <td>X</td> <td>X</td> <td>POS</td> </tr> <tr> <td>H</td> <td>1.2</td> <td>1.2</td> <td>1.2</td> </tr> <tr> <td>L</td> <td></td> <td></td> <td></td> </tr> <tr> <td>X</td> <td></td> <td></td> <td></td> </tr> </tbody> </table> <p>Below the table is the 'Pattern Type' section with AND, NAND, OR, and NOR options.</p>	Ch1	Ch2	Ch3	Ch4 (Clk)	H	X	X	POS	H	1.2	1.2	1.2	L				X			
Ch1	Ch2	Ch3	Ch4 (Clk)																			
H	X	X	POS																			
H	1.2	1.2	1.2																			
L																						
X																						
<p>Set threshold voltages</p>	<ol style="list-style-type: none"> 5. To set the threshold voltages, click on the channel threshold control and use the multipurpose knobs or pop-up keypad to set each threshold. 	 <p>The screenshot shows the 'Input Threshold' window with numerical values entered for the thresholds:</p> <table border="1"> <thead> <tr> <th>Ch1</th> <th>Ch2</th> <th>Ch3</th> <th>Ch4 (Clk)</th> </tr> </thead> <tbody> <tr> <td>H</td> <td>X</td> <td>X</td> <td>POS</td> </tr> <tr> <td>1.4</td> <td>1.2</td> <td>1.2</td> <td>1.2</td> </tr> <tr> <td>L</td> <td></td> <td></td> <td></td> </tr> <tr> <td>X</td> <td></td> <td></td> <td></td> </tr> </tbody> </table> <p>The 'Pattern Type' section shows AND, NAND, OR, and NOR options.</p>	Ch1	Ch2	Ch3	Ch4 (Clk)	H	X	X	POS	1.4	1.2	1.2	1.2	L				X			
Ch1	Ch2	Ch3	Ch4 (Clk)																			
H	X	X	POS																			
1.4	1.2	1.2	1.2																			
L																						
X																						

Overview	To trigger on state	Control elements and resources
<p>Define logic</p>	<p>6. Select the Boolean logic function for the combination of the input channels. The oscilloscope will trigger on a clock edge when the input waveforms match the specified logic pattern. (The Pattern Type controls do not appear on this control window for the TDS5052 model.)</p> <p>See page 3-64 for definitions of the logic functions for pattern triggers.</p>	
<p>Set trigger criteria</p>	<p>7. Use the Trigger When Pattern selection to determine when the oscilloscope should trigger. Select True to trigger the oscilloscope when the logic patterns go true. Select False to trigger the oscilloscope when the logic patterns go false.</p> <p>For simplest operation, leave this control set to True. Setting the control to False complements the output of the chosen pattern function (for example, from AND to NAND or NOR to OR).</p>	
<p>Set mode and holdoff</p>	<p>8. Mode and holdoff can be set for all standard trigger types. Refer to <i>Select the trigger mode</i> on page 3-56 and <i>Set holdoff</i> on page 3-59. To learn more about trigger mode and holdoff, see <i>Trigger Modes</i> on page 3-51 and <i>Trigger Holdoff</i> on page 3-52.</p>	 <p>For mode and holdoff setup, see <i>Select the trigger mode</i> on page 3-56 and <i>Set holdoff</i> on page 3-59.</p>

Triggering on Setup/ Hold Time Violations

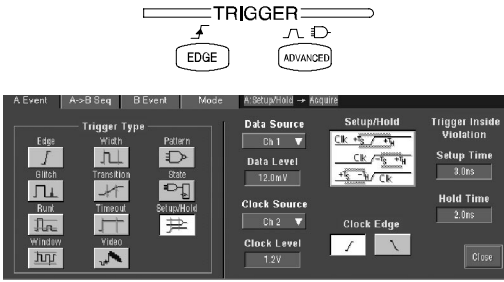
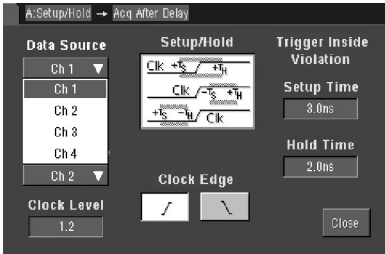
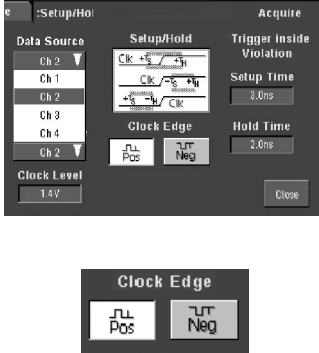
Use this procedure to detect and trigger on setup and hold time violations. The setup and hold times define a violation region relative to a clock. Data is considered to be invalid in the violation region.

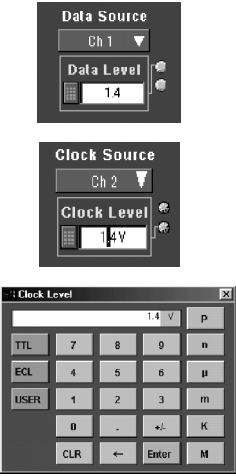
Overview	To trigger on setup/hold time violations	Control elements and resources
<p>Select setup/hold triggering</p>	<ol style="list-style-type: none"> 1. Push the front-panel ADVANCED button. 2. On the Trigger Setup control window, select the A Event tab. 3. Click Setup/Hold. 	 <p>The diagram shows a 'TRIGGER' label with two arrows pointing to 'EDGE' and 'ADVANCED' buttons. Below it is a screenshot of the 'A Event' tab in the Trigger Setup control window. The 'Trigger Type' section has 'Setup/Hold' selected. The 'Data Source' is set to 'Ch 1', 'Data Level' is '12.0mV', 'Clock Source' is 'Ch 2', and 'Clock Level' is '1.2V'. The 'Trigger Inside Violation' section shows 'Setup Time' at 3.0ns and 'Hold Time' at 3.0ns.</p>
<p>Select the data source</p>	<ol style="list-style-type: none"> 4. To select the channel that is connected to the data signal, click Data Source and select the source from the list. Do not select the same channel for both the data and clock sources. 	 <p>The screenshot shows the 'A:Setup/Hold' control window. The 'Data Source' dropdown is set to 'Ch 1'. The 'Setup/Hold' section shows a diagram of a clock signal with setup and hold time regions. The 'Trigger Inside Violation' section shows 'Setup Time' at 3.0ns and 'Hold Time' at 2.0ns. The 'Clock Edge' section has two buttons: a rising edge (left) and a falling edge (right).</p>
<p>Select the clock source and set the edge</p>	<ol style="list-style-type: none"> 5. To select the channel that is to contain the clock signal and the edge to use to clock, click Clock Source and select the source from the list. Do <i>not</i> select the same channel for both the data and clock sources. 6. The Clock Edge determines whether the oscilloscope finds the trigger point on the rising edge (left button) or the falling edge (right button) of the clock signal. Click a Clock Edge button. 	 <p>The screenshot shows the 'A:Setup/Hold' control window. The 'Data Source' is 'Ch 2' and the 'Clock Source' is 'Ch 2'. The 'Clock Edge' section has two buttons: 'Pos' (left) and 'Neg' (right). Below the screenshot is a separate 'Clock Edge' control window with 'Pos' and 'Neg' buttons.</p>

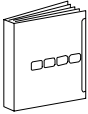
Overview	To trigger on setup/hold time violations	Control elements and resources
<p>Set the data and clock levels</p>	<p>7. To set the data transition level, click Data Level, and use the multipurpose knobs or pop-up keypad to set the value.</p> <p>8. The oscilloscope uses the clock level to determine when a clock edge occurs. The point the clock crosses the clock level is the reference point from which it measures setup and hold time settings. To set the clock threshold level, click Clock Level and use the multipurpose knobs or pop-up keypad to set the value.</p> <p>Both Clock and Data Levels can be set to a value appropriate to either the TTL or ECL logic families by clicking TTL or ECL on the Level pop-up keypad.</p>	 <p>The figure shows three control panels. The top panel is 'Data Source' for Channel 1, with 'Data Level' set to 1.4. The middle panel is 'Clock Source' for Channel 2, with 'Clock Level' set to 1.4V. The bottom panel is a 'Clock Level' keypad showing '1.4 V' and a grid of logic families: TTL (7, 8, 0, n), ECL (4, 5, 6, μ), and USER (1, 2, 3, m), along with function keys like CLR, ←, Enter, and M.</p>
<p>Set the setup and hold times</p>	<p>9. Click Setup Time and use the multipurpose knob or pop-up keypad to set the setup time relative to the clock.</p> <p>10. Click Hold Time and use the multipurpose knob or pop-up keypad to set the hold time relative to the clock.</p> <p>Positive setup time always leads the clock edge; positive hold time always follows the clock edge. Setup time always leads the hold time by at least 2 ns ($T_S + T_H \geq 2 \text{ ns}$). Attempting to set either time to reduce the 2 ns limit adjusts the other time to maintain the limit.</p> <p>See Figure 3-25 for an example of a setup and hold violation trigger.</p> <p>In most cases, you will enter positive values for both setup and hold time. Positive values set the oscilloscope to trigger if the data source is still settling inside the setup time before the clock or if it switches inside the hold time after the clock. You can skew this “setup/hold violation zone” by entering negative values. See Figure 3-24 on page 3-66.</p>	 <p>The figure shows the 'Trigger Inside Violation' control panel with 'Setup Time' set to 3.0ns and 'Hold Time' set to 2.0ns.</p>
<p>Set mode and holdoff</p>	<p>11. Mode and holdoff can be set for all standard trigger types. Refer to <i>Select the trigger mode</i> on page 3-56 and <i>Set holdoff</i> on page 3-59. To learn more about trigger mode and holdoff, see <i>Trigger Modes</i> on page 3-51 and <i>Trigger Holdoff</i> on page 3-52.</p>	 <p>For mode and holdoff setup, see <i>Select the trigger mode</i> on page 3-56 and <i>Set holdoff</i> on page 3-59.</p>

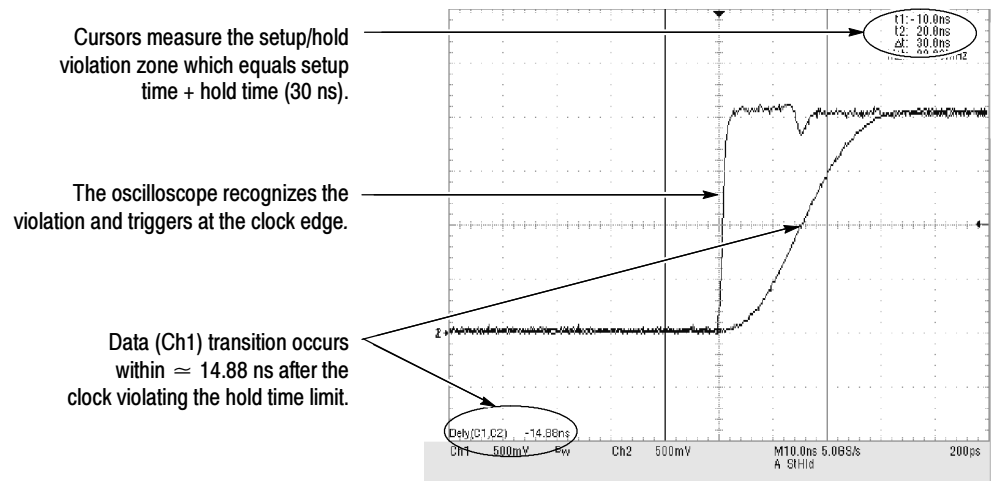
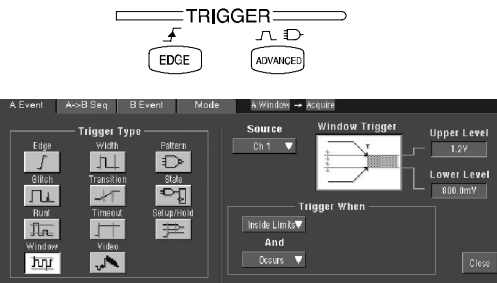
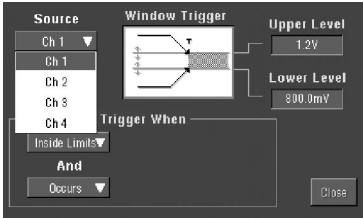
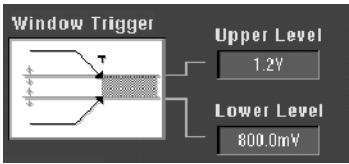
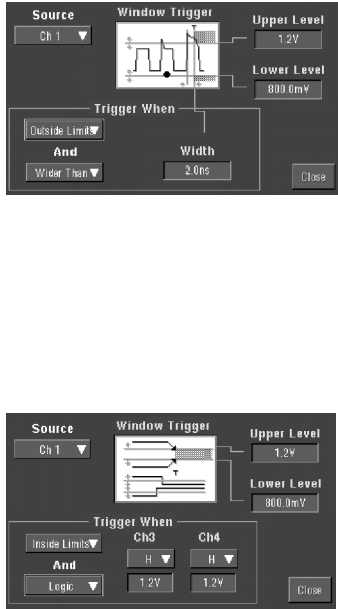
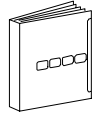

Figure 3-25: Triggering on a Setup/Hold time violation

Triggering on Window Threshold Violations



Use this procedure to trigger the oscilloscope when the input signal rises above an upper threshold level or falls below a lower threshold level.



Overview	To trigger on a window threshold violation	Control elements and resources
<p>Select window triggering</p>	<ol style="list-style-type: none"> 1. Push the front-panel ADVANCED button. 2. On the Trigger Setup control window, select the A Event tab. 3. Click Window. 	 <p>The diagram shows the physical TRIGGER button with 'EDGE' and 'ADVANCED' options. Below it is a screenshot of the 'Trigger Setup' window, where the 'Window' tab is selected under the 'Trigger Type' section. The 'Source' is set to 'Ch 1', and the 'Upper Level' is 1.2V and 'Lower Level' is 800.0mV.</p>
<p>Select the source</p>	<ol style="list-style-type: none"> 4. To specify which channel becomes the trigger source, click Source and select the source from the list. 	 <p>The screenshot shows the 'Source' dropdown menu open, listing 'Ch 1', 'Ch 2', 'Ch 3', and 'Ch 4'. The 'Window Trigger' window is also visible in the background with the 'Upper Level' at 1.2V and 'Lower Level' at 800.0mV.</p>
<p>Set the thresholds</p>	<ol style="list-style-type: none"> 5. The upper and lower threshold levels define the voltage limits of the window. To set the threshold levels, click Upper Level or Lower Level, and use the multipurpose knobs or pop-up keypad to set the values. 	 <p>The screenshot shows the 'Window Trigger' window with the 'Upper Level' field set to 1.2V and the 'Lower Level' field set to 800.0mV.</p>

Overview	To trigger on a window threshold violation	Control elements and resources
<p>Qualify window trigger</p>	<p>6. To qualify the window trigger, select from these Trigger When drop-down list combinations. Note that the Trigger When controls change as you select different combinations of options.</p> <ul style="list-style-type: none"> ■ Inside Limits and Occurs or Outside Limits and Occurs: Trigger the oscilloscope when the signal enters (or leaves) the window defined by the threshold levels. ■ Inside Limits and Wider Than or Outside Limits and Wider Than: Trigger the oscilloscope when the signal enters (or leaves) the window defined by the threshold levels for the time specified by Width. ■ Inside Limits and Logic or Outside Limits and Logic: When the oscilloscope detects a signal entering or leaving the window defined by the threshold levels, it checks the logic state of up to two other available channels and triggers only if their conditions are met. Each channel can have a value of high (H), low (L), or "don't care" (X). A value is considered high if the channel input voltage is greater than the specified threshold voltage; a value is considered low if the channel input voltage is less than the specified threshold voltage. Use the "don't care" selection for any channels that will not be used as part of the pattern. (Logic qualification is only available on the TDS5054 and TDS5104 models.) 	
<p>Set mode and holdoff</p>	<p>7. Mode and holdoff can be set for all standard trigger types. Refer to <i>Select the trigger mode</i> on page 3-56 and <i>Set holdoff</i> on page 3-59. To learn more about trigger mode and holdoff, see <i>Trigger Modes</i> on page 3-51 and <i>Trigger Holdoff</i> on page 3-52.</p>	 <p>For mode and holdoff setup, see <i>Select the trigger mode</i> on page 3-56 and <i>Set holdoff</i> on page 3-59.</p>

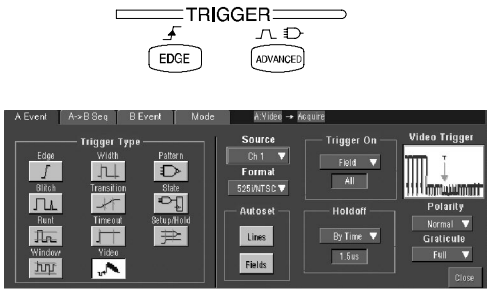
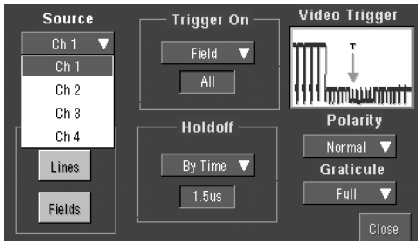
Triggering on a Video Signal

Use this procedure to detect and trigger on a video signal. Only composite signal formats are supported. Graphic display formats such as RGB and VGA are not supported.

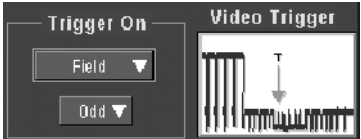
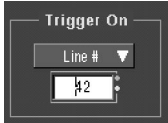
Overview	To trigger on a video signal	Control elements and resources
<p>Select video triggering</p>	<ol style="list-style-type: none"> 1. Push the front-panel ADVANCED button. 2. On the Trigger Setup control window, select the A Event tab. 3. Click Video. 	
<p>Select the source</p>	<ol style="list-style-type: none"> 4. To specify which channel becomes the trigger source, click Source and select the source from the list. 	
<p>Select the format</p>	<ol style="list-style-type: none"> 5. Select the video signal format from several preset formats or set a custom format. If using a preset format, click the Lines and Fields Autoset buttons to optimize the oscilloscope for viewing the fields or lines for your chosen format. <p>If you select the Custom signal format, no Autoset options are available. You must set the Scan Type (Interlaced or Progressive) and Scan Rate.</p> <p>Custom scan rates enable you to trigger on non-broadcast video signals that have unique scan rates. Select the scan rate that includes your signal: 15-20 kHz, 20-25 kHz, 25-35 kHz, 35-50 kHz, or 50-65 kHz.</p>	

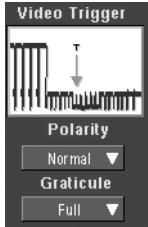
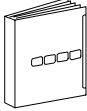
Overview	To trigger on a video signal	Control elements and resources
<p>Specify where trigger will occur on the video signal</p>	<p>6. Select a value from the Trigger On drop-down list to specify where the trigger will occur on the video signal:</p> <ul style="list-style-type: none"> ■ If you select Field, use the drop-down list to select either Odd, Even, or All. ■ If you select Line #, use the multipurpose knob to set the line number. Line numbers wrap when their limits are reached. The range of line numbers depends on the format. <p>If you select the NTSC format, use the multipurpose knob to first scroll through all of the odd lines, then the even lines.</p> <ul style="list-style-type: none"> ■ If you select All Lines, the trigger will occur on any and all lines. 	 
<p>Set the holdoff type</p>	<p>7. Specify Holdoff By Time or By Fields, and use the multipurpose knob to change the value. If setting a Custom format, only the By Time control is available.</p>	
<p>Select the polarity and graticule type</p>	<p>8. Select Normal or Inverted polarity:</p> <ul style="list-style-type: none"> ■ Normal generally triggers on negative polarity, since the sync pulse leading edge is negative for most standard formats. ■ Use Inverted when probing circuitry that inverts the video signal. <p>9. All graticule types are available for selection from the drop-down list. The IRE graticule is normally used with NTSC signals, and the mV graticule is normally used with all other video signals.</p>	
<p>Set mode and holdoff</p>	<p>10. Mode and holdoff can be set for all standard trigger types. Refer to <i>Select the trigger mode</i> on page 3-56 and <i>Set holdoff</i> on page 3-59. To learn more about trigger mode and holdoff, see <i>Trigger Modes</i> on page 3-51 and <i>Trigger Holdoff</i> on page 3-52.</p>	 <p>For mode and holdoff setup, see <i>Select the trigger mode</i> on page 3-56 and <i>Set holdoff</i> on page 3-59.</p>

Sequential Triggering

In applications that involve two or more signals, you may be able to use sequential triggering to capture more complex events. Sequential triggering uses the A (Main) trigger to arm the trigger system, and then uses the B (Delayed) trigger to trigger the oscilloscope if a specific condition is met. You can choose one of two trigger conditions:

- *Trigger After Time:* After the A trigger arms the trigger system, the oscilloscope triggers on the next B-trigger event that occurs after the trigger delay time. You can set the trigger delay time with the keypad or the multipurpose knobs.
- *Trigger on nth Event:* After the A trigger arms the trigger system, the oscilloscope triggers on the nth B event. You can set the number of B events with the keypad or the multipurpose knobs.

NOTE. *The traditional delayed trigger mode called “Runs After” is served by the TDS5000 feature Horizontal Delay. You can use horizontal delay to delay acquisition from any trigger event, whether from the A (Main) trigger alone or from a sequential trigger that uses both the A (Main) and B (Delayed) triggers. See Triggering with Horizontal Delay On on page 3-93 for more information.*

Using Sequential Triggering

Keep in mind the following when using sequential triggers.

Trigger Sources. In most cases, you will set separate trigger sources for the A (Main) and B (Delayed) triggers.

Trigger Types. Sequential triggering for Trigger after Time or Trigger on nth Event is available for the Edge, Glitch, and Width types. It is not available for the rest of the trigger types.

The B trigger is always the Edge type.

Triggering with Horizontal Delay Off. Figure 3-26 compares the sequential trigger choices A Only, Trig After Time, and Trig on nth Event when horizontal delay is off. Each illustration shows where pretrigger and posttrigger data is acquired relative to the trigger event.

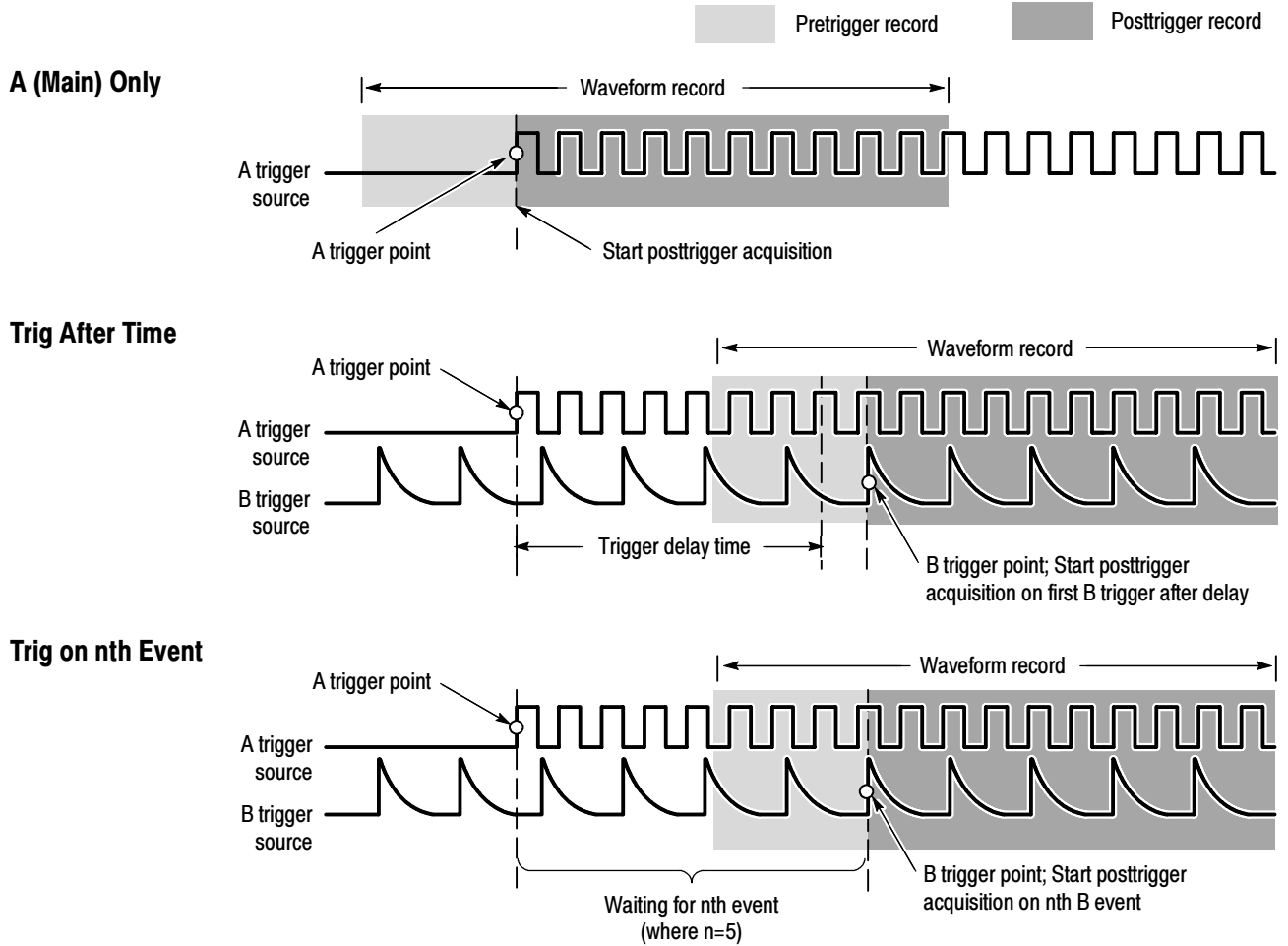

Figure 3-26: Triggering with Horizontal Delay off

Triggering with Horizontal Delay On. You can use horizontal delay when you want to acquire a waveform record that is separated from the trigger event by a significant interval of time. The horizontal delay function can be used with any trigger setup. You can turn horizontal delay on and off from the front panel, the Horizontal/Acquisition control window, and many of the Trigger control windows. Figure 3-27 compares the sequential trigger choices A Only, Trig After Time, and Trig on nth Event when horizontal delay is on. Each illustration shows where pretrigger and posttrigger data is acquired relative to the trigger event.

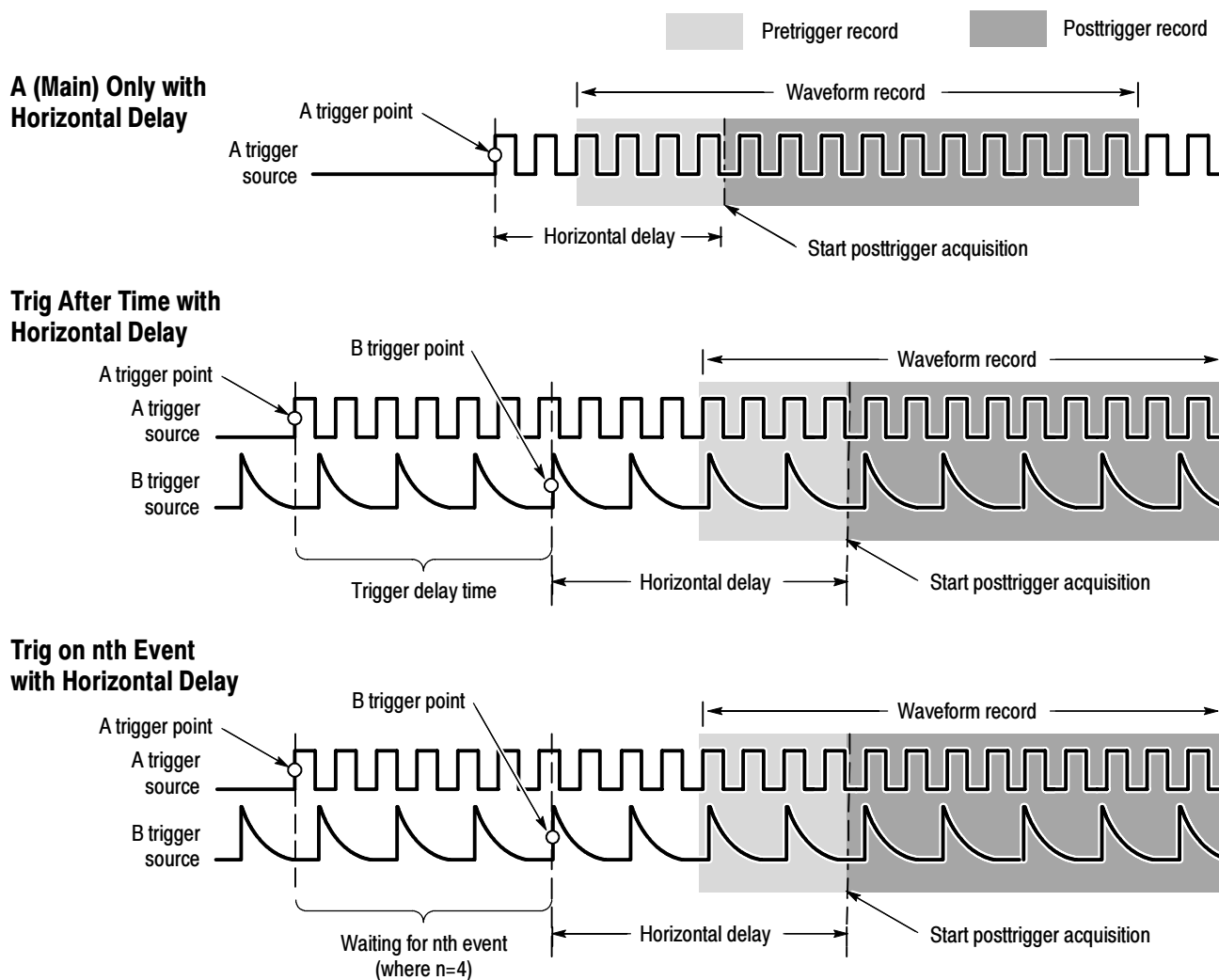

Figure 3-27: Triggering with Horizontal Delay on

Figure 3-28 summarizes all combinations of triggering and horizontal delay.

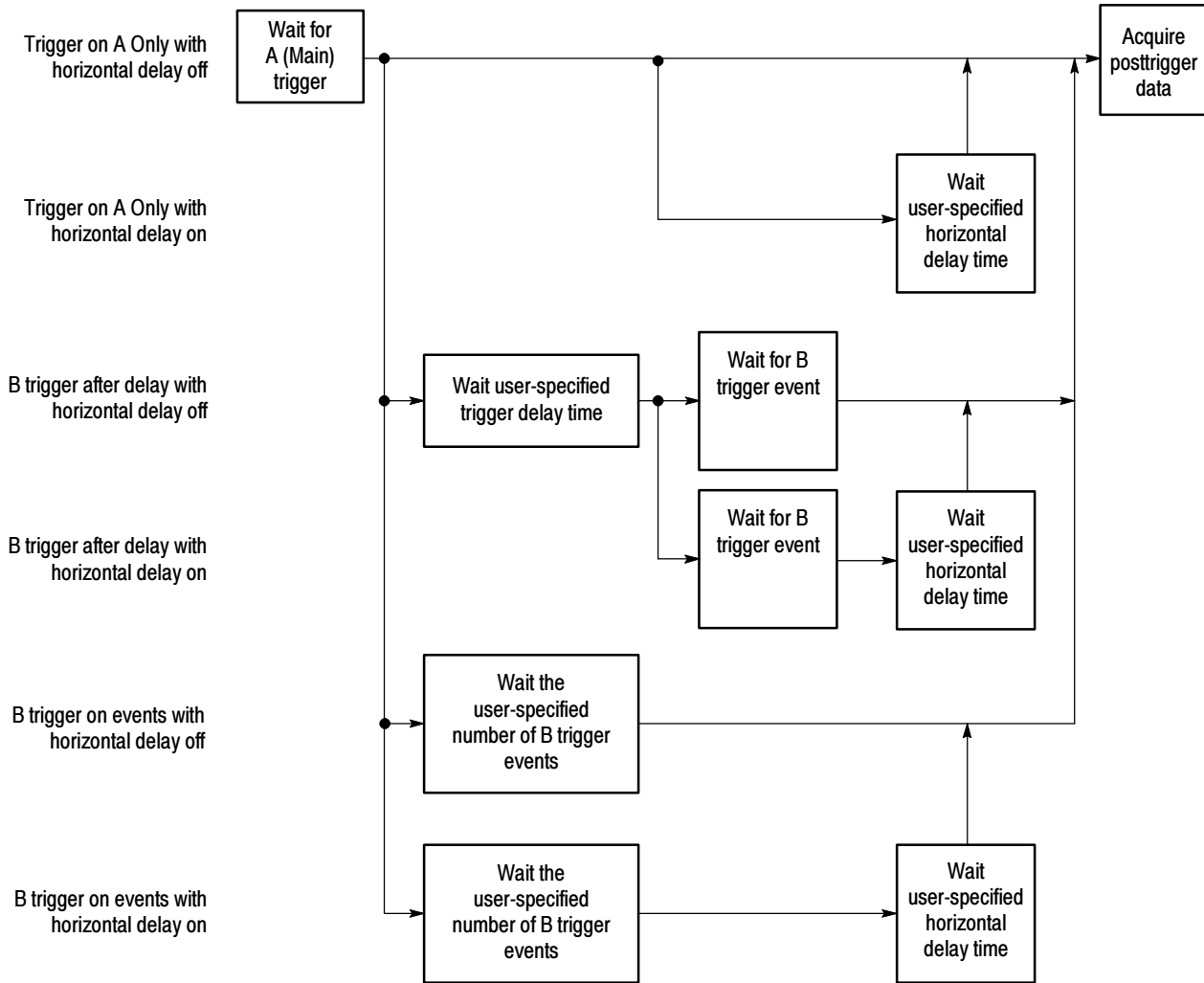
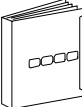

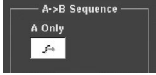

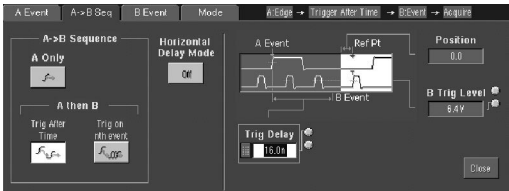
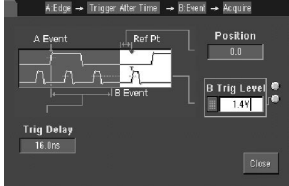

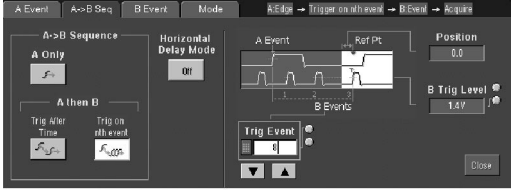
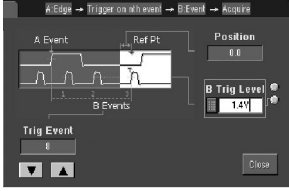

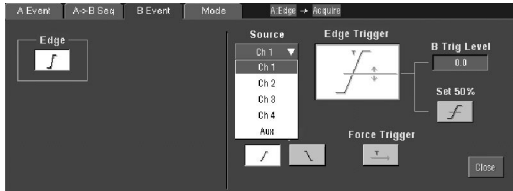
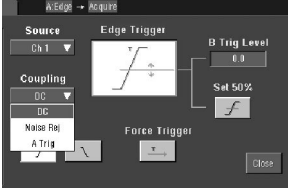

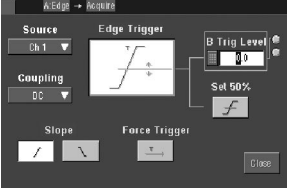

Figure 3-28: Trigger and Horizontal Delay summary

Triggering on a Sequence Use these procedures to set up the oscilloscope to trigger on a sequence. For more information, display online help while performing the procedure.

Overview	To trigger on a sequence	Control elements and resources
<p>Prerequisites</p>	<ol style="list-style-type: none"> The oscilloscope must be installed with a signal connected to an input channel. Set the acquisition system to RUN, and set the vertical and horizontal controls appropriately for the signal to be acquired. 	 <p>See page 3-21 for acquisition setup</p>
<p>To trigger on A (main) only</p>	<ol style="list-style-type: none"> Click Trig on the toolbar, and select the A->B Seq tab of the Trigger Setup control window. Click A Only to turn off sequential triggering. 	 
<p>To trigger on B after time</p>	<ol style="list-style-type: none"> To set the time base to run after an A trigger, a trigger delay, and a B trigger, click Trig on the toolbar and select the A->B Seq tab of the Trigger Setup control window. Click Trig After Time. To set the trigger delay, click Trig Delay and use the multipurpose knob or pop-up keypad to set the time. To set the B trigger level, click B Trig Level and use the multipurpose knob or pop-up keypad to set the level. 	  

Overview	To trigger on a sequence	Control elements and resources
<p>To trigger on B events</p>	<ol style="list-style-type: none"> To set the time base to trigger after an A trigger and a specified number of B trigger events, click Trig on the toolbar, and select the A->B Seq tab of the Trigger Setup control window. Click Trig on nth event. To set the number of B trigger events, click Trig Event and use the multipurpose knob, pop-up keyboard, or up and down arrows to set the number of events. To set the B trigger level, click B Trig Level, and use the multipurpose knob or pop-up keypad to set the level. 	  
<p>To set up B triggering</p>	<ol style="list-style-type: none"> To set the B Event trigger, click Trig on the toolbar, and select the B Event tab of the Trigger Setup control window. Or, from the menu bar, select the B Event (Delayed) Trigger Setup command. To specify which channel becomes the B trigger source, click Source and select the source from the list. Click Coupling and select the trigger coupling to match your trigger signal. To specify the direction of the edge, click a Slope button. The left button selects a positive slope and the right button selects a negative slope. To set the B trigger level, click B Trig Level, and use the multipurpose knob or pop-up keypad to set the level. Note that you can click Set 50% to set the B trigger level to the midpoint between the positive and negative peak of the B trigger signal. 	    

Overview	To trigger on a sequence	Control elements and resources
<p>For further assistance</p>	<p>6. Access the online help for more assistance on triggering commands.</p>	<div data-bbox="1149 369 1279 478" data-label="Image"> </div> <p data-bbox="1024 485 1425 512">See page 3-209 for information on online help</p>

Displaying Waveforms

This oscilloscope includes a flexible, customizable display that lets you control how waveforms appear. This section discusses:

- *Using the Waveform Display*
- *Customizing the Waveform Display*
- *Using the Zoom Feature*

Figure 3-29 shows how the display features fit into the overall oscilloscope operation.

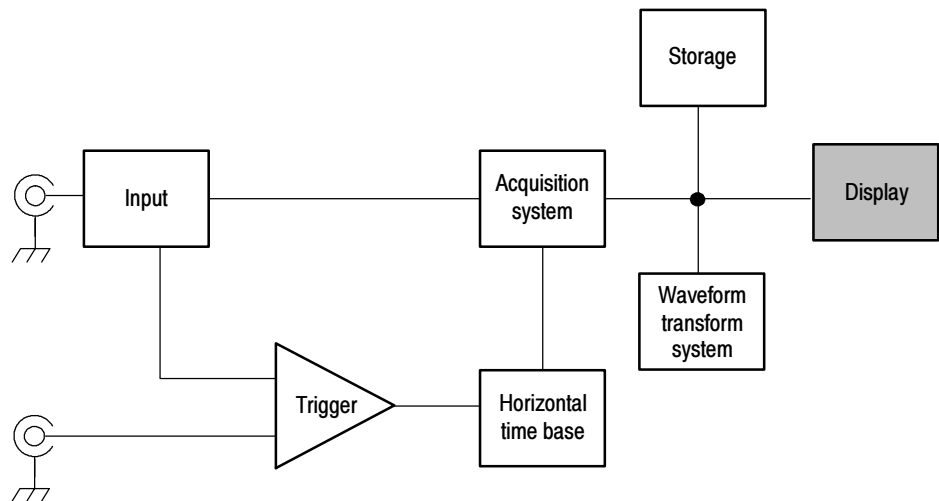

Figure 3-29: Oscilloscope System Overview: Customizable Display

Using the Waveform Display

Display Elements The waveform shown below is displayed as part of the user interface (UI) application. Some terms that are useful in discussing the UI follow.

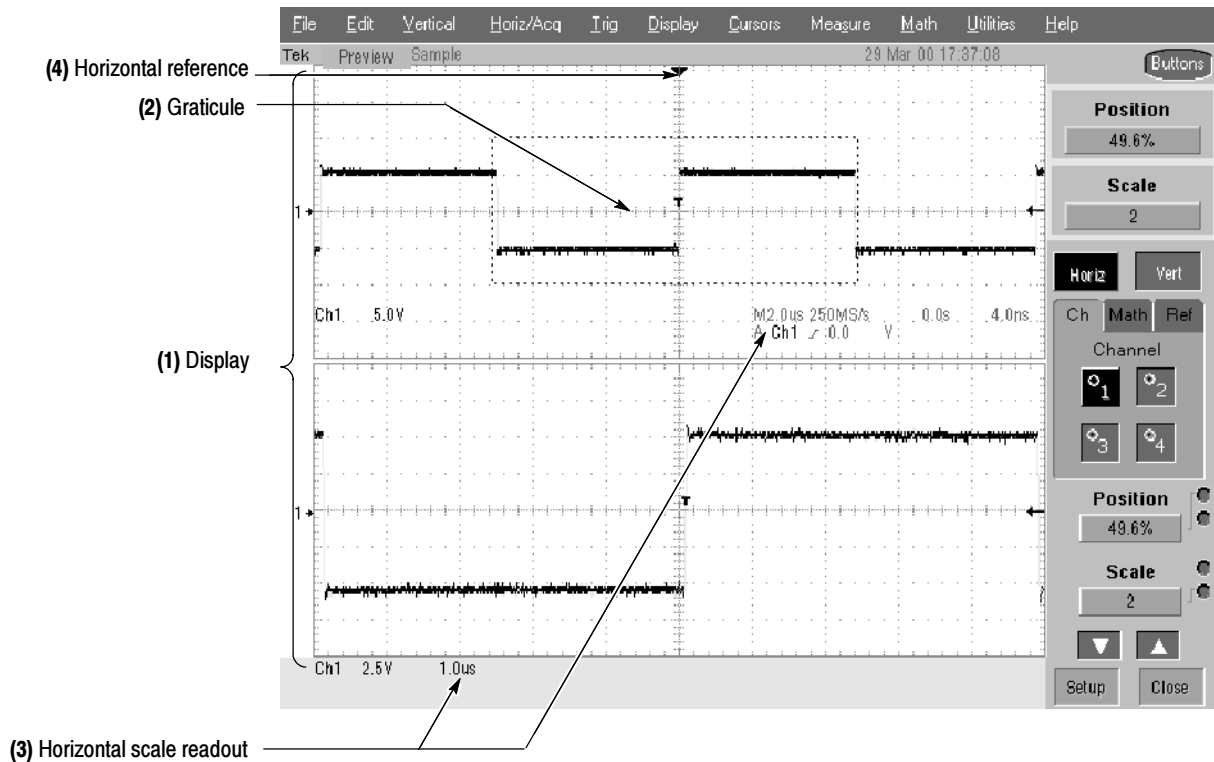

Figure 3-30: Display elements

- (1) The **Display** is the area where the waveforms appear. The display comprises the time base and graticules, the waveforms, histograms, and some readouts.
- (2) The **Graticule** is the grid marking the display area. When Zoom is on, depending on the graticule split setting, the upper graticule displays unmagnified waveforms and the lower graticule displays magnified waveforms.
- (3) The **Horizontal scale readout** provides a quick overview of the horizontal settings for magnified and unmagnified waveforms.
- (4) The **Horizontal reference** is a control that you can position to set the point around which channel waveforms expand and contract horizontally on screen as you change the Horizontal Scale control. It is also the trigger point when the horizontal delay is 0%.

Acquisition Preview

The acquisition preview attempts to show what the next acquisition will look like when the acquisition is delayed due to slow triggers or long acquisition duration, or the acquisitions have stopped. Acquisition preview recalculates math waveforms, but does not represent changes in trigger levels, trigger modes, or different acquisition modes.

Acquisition preview has some limitations. For example, if the record length is changed, the waveforms are erased. Changing the horizontal scale can change the record length in some cases.

Note that there is no acquisition preview in Fast Acquisitions mode.

Display Methods

Use these features to optimize the oscilloscope display to support your data analysis tasks.

Waveform Display. In general, the method of displaying a waveform is to:

- Define the waveform (math and reference waveforms only)
- Enable the waveform display

Table 3-6 summarizes this process as it applies to the different types of waveforms.

Table 3-6: Defining and displaying waveforms

Waveform	To define	To display
Channel: Ch1 - Ch4	Channels are predefined	Push the Vertical CH <i>n</i> button to toggle the channel display on or off.
Reference: Ref1 - Ref4	Define an active reference waveform by: <ul style="list-style-type: none"> ■ Saving a channel, reference, or math waveform to one of locations Ref1 - Ref4. ■ Recalling a waveform previously saved to a file into one of locations Ref1 - Ref4. Perform these operations from the File menu.	From the Reference Setup control window, click Display on the Ref <i>n</i> tab to toggle the reference waveform display on and off.
Math: Math1 - Math4	Create a math waveform using existing sources (channel, math, and reference waveforms; measurements). Depending on the options you have purchased, several methods may be available for using calculations to create math waveforms.	From the Math Setup control window, click Display on the Math <i>n</i> tab to toggle the math waveform display on and off.

Display Operations In general, the method of adjusting (vertically scaling, offsetting, positioning, and so on) the waveform display is from the front-panel vertical SCALE and POSITION knobs. Note that math and reference waveforms are scaled and positioned from their setup control windows.

Graticules. Click a Graticule Split button in the Zoom Setup control window to change the size of the acquisition waveform and zoomed waveform windows. The 50-50 button allocates half of the available display for the zoomed graticule and half of the available display for the acquisition window. The 80-20 button allocates 80% of the available display for the zoomed graticule and 20% for the acquisition window. Click Full to use the entire display for the zoomed graticule.

The display elements, as shown in Figure 3-30 on page 3-100, are the same for each graticule.

Operations on the Time base. In general, the method of adjusting the time base is from the front-panel horizontal SCALE, RESOLUTION, and POSITION knobs. Only channel waveforms can be set directly.

Here are some key points to remember about how horizontal operations relate to the waveform types:

- Reference waveforms are shown with the horizontal settings in effect at the time they are saved. You cannot adjust these settings. See *Saving and Recalling Waveforms* on page 3-189 for more information on reference waveforms.
- Math waveforms are shown with the horizontal settings derived from the math expression that creates them. You cannot change these directly. See *Creating and Using Math Waveforms* on page 3-135 for more information on math waveforms.
- All waveforms are displayed within the horizontal divisions that the graticule provides. However, some waveforms may actually be wider or narrower than the display due to acquisition rate/time scale combinations and acquisition preview.

Display and Acquisition Controls. For channel waveforms, the vertical and horizontal controls you set also adjust the oscilloscope acquisition parameters. See the following descriptions for more information:

- *Vertical Acquisition Window Considerations* on page 3-14
- *Horizontal Acquisition Window Considerations* on page 3-18

Horizontal Position and the Horizontal Reference Point. The time value you set for horizontal position is measured from the trigger point to the horizontal reference point. This is not the same as the time value from the trigger point to the start of the waveform record, unless you set the horizontal reference to 0%. See Figure 3-31.

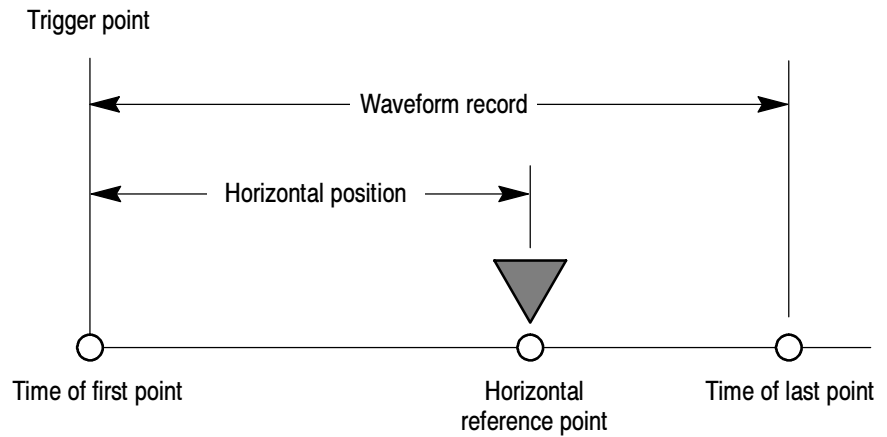
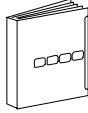
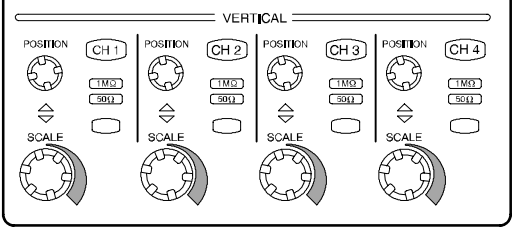
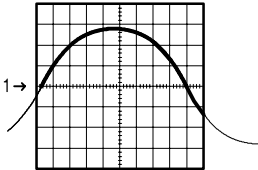
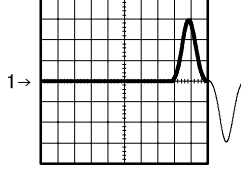
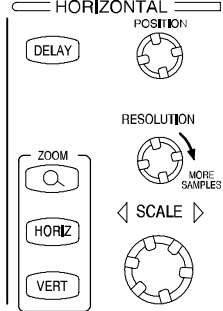

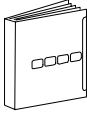

Figure 3-31: Horizontal position includes time to horizontal reference point

Displaying Waveforms in the Main Graticule

This procedure demonstrates the display adjustments you can make.

Overview	To display waveforms in the main graticule	Control elements and resources
<p>Prerequisites</p>	<p>1. The oscilloscope must be installed with a signal connected to an input channel. Set the acquisition system to RUN.</p>	 <p>See page page 3-25 for acquisition setup.</p>
<p>Set vertical display parameters</p>	<p>2. Push the CH button of the channel with the connected signal to display the waveform. The CH button is lit.</p> <p>3. Adjust the front-panel vertical controls to achieve a good display of the waveform.</p>	
<p>Set horizontal display parameters</p>	<p>4. To ensure that the main graticule is selected, push the front-panel ZOOM button, if it is lit, to toggle it off.</p> <p>5. Use the front-panel horizontal knobs to adjust the SCALE and POSITION of the waveform and to set sample RESOLUTION.</p> <p>Scaled Horizontally</p>  <p>Positioned Horizontally</p>  <p>The RESOLUTION knob also sets the record length. (See discussion on page 3-19.)</p> <p>Push the LEVEL knob (PUSH TO SET 50%) if required to stabilize the display.</p>	 <p>LEVEL PUSH TO SET 50%</p> 

Overview	To display waveforms in the main graticule	Control elements and resources
<p>Adjust the horizontal reference</p>	<p>6. To adjust the point around which the waveform expands and contracts, click on the horizontal reference marker and drag it along the horizontal axis until it aligns to the point on the waveform that you want to be stationary on screen.</p> <p>Note that if horizontal delay is off, the horizontal reference point is the same as the horizontal position.</p> <p>7. Release the Horizontal Reference, and then adjust the Horizontal Scale to expand or contract the waveform.</p>	<p>Horizontal reference</p> 
<p>Explore the zoom controls</p>	<p>8. A subsequent procedure in this section discusses setting up and controlling Zoom.</p>	 <p>See <i>Using the Zoom Feature</i> on page 3-110.</p>

Customizing the Waveform Display

Using Display Controls Read this section to learn how to to display waveforms according to your preferences.

Display Settings. Table 3-7 lists customizable display elements and their points of access.

Table 3-7: Customizable display elements

Display attribute	Access	Options
Graticule Style	Display menu Graticule Style command or Display Setup control window Objects tab (Disp toolbar button)	<ul style="list-style-type: none"> ■ Full provides a grid, cross hairs, and frame on the oscilloscope display. Use for quick estimates of waveform parameters. ■ Grid shows a frame and grid on the oscilloscope display. Use for full-screen measurements with cursors and automatic readouts when cross hairs are not needed. ■ Cross Hair shows cross hairs and a frame on the oscilloscope display. Use for making quick estimates of waveforms while leaving more room on the display for automatic readouts and other data. ■ Frame shows only a frame on the oscilloscope display. Use with automatic readouts and other screen text when other display features are not needed. ■ IRE is used for NTSC video signals. ■ mV is used for video signals other than NTSC.
Display Persistence	Display menu Display Persistence submenu commands or Display Setup control window Appearance tab (Disp toolbar button)	<ul style="list-style-type: none"> ■ Infinite persistence continuously accumulates record points on the waveform until you change one of the acquisition display settings. Use for displaying points that may occur outside the normal acquisition envelope. ■ Variable persistence accumulates record points on the waveform for a specified time interval. Each record point decays independently according to the time interval. ■ Off shows waveform record points for the current acquisition only. Each new waveform record replaces the previously acquired record for a channel.

Table 3-7: Customizable display elements

Display attribute	Access	Options
Display Style	Display menu Display Style submenu commands or Display Setup control window Appearance tab (Disp toolbar button)	<ul style="list-style-type: none"> ■ Vectors display waveforms with lines drawn between record points. ■ Dots display waveform record points as dots on the screen. ■ Inten Samp (Intensified Samples) shows the actual samples as intensified dots.
Screen Text	Display menu Screen Text command or Display Setup control window Screen Text tab (Disp toolbar button)	<ul style="list-style-type: none"> ■ Up to eight (8) lines of text provides notes for screen shots, printouts, or for other oscilloscope users. ■ Display turns the text display on and off. ■ Properties opens the Text Properties control window for positioning of the text on the display. ■ Clear erases the entire text of the selected line.
Color Palette (Graticule and Waveform)	Display menu Colors command or Display menu Display Palette submenu or Display Setup control window Colors tab (Disp toolbar button)	<ul style="list-style-type: none"> ■ Normal displays hues and lightness levels for best overall viewing. The color of each channel waveform matches the color of the corresponding front-panel vertical SCALE knob. ■ On the Spectral (Spectral Grading) palette, areas of the waveform with the highest sample density appear in blue shades while the areas of lowest sample density appear in red shades. ■ On the Temp (Temperature Grading) palette, areas of the waveform with the highest sample density appear in warmer colors (red shades) while the areas of lowest sample density appear in cooler colors (blue shades). ■ Gray (Monochrome Gray) displays waveforms in shades of gray. Areas of the waveform with the highest sample density appear in lighter gray shades while the areas of lowest sample density appear in darker gray shades. ■ Green (Monochrome Green) displays waveforms in shades of green. Areas of the waveform with the highest sample density appear in lighter green shades while the areas of lowest sample density appear in darker green shades.
Reference Colors	Display menu Colors command or Display Setup control window Colors tab (Disp toolbar button)	<ul style="list-style-type: none"> ■ Default uses the default system color (white) for reference waveforms. ■ Inherit uses the same color for the reference waveform as the original waveform.

Table 3- 7: Customizable display elements

Display attribute	Access	Options
Math Colors	Display menu Colors command or Display Setup control window Colors tab (Disp toolbar button)	<ul style="list-style-type: none"> ■ Default uses the default system color (red) for math waveforms. ■ Inherit uses the same color for the math waveform as the waveform the math function is based on.
Waveform Interpolation	Display menu Waveform Interpolation sub-menu or Display Setup control window Appearance tab (Disp toolbar button)	<ul style="list-style-type: none"> ■ Sin(x)/x interpolation ■ Linear interpolation <p>Refer to page 3-109 for more information.</p>
Waveform Intensity	Display menu Appearance command or Display Setup control window Appearance tab (Disp toolbar button)	<ul style="list-style-type: none"> ■ When AutoBright is Off, the display simulates the appearance of analog oscilloscope signals. Waveforms that trigger more frequently appear brighter than waveforms that trigger less frequently. Use the front-panel INTENSITY knob or the multipurpose knobs to manually adjust the display intensity when AutoBright is Off. ■ When AutoBright is On, the intensity of the waveform changes automatically to provide a visible waveform.
Display Format	Display menu Appearance command or Display menu Display Format sub-menu or Display Setup control window Appearance tab (Disp toolbar button)	<ul style="list-style-type: none"> ■ YT ■ XY ■ XYZ <p>For additional information, see <i>Setting the Display Format</i> on page 3-41.</p>
Trigger Level Marker	Display menu Objects command or Display Setup control window Objects tab (Disp toolbar button)	<ul style="list-style-type: none"> ■ The Short trigger level marker displays a short arrow on the side of the graticule by the active waveform. ■ The Long trigger level marker displays a horizontal line through the active waveform.
LCD Backlight Timeout	Display menu Objects command or Display menu LCD Save Enabled command or Display Setup control window Objects tab (Disp toolbar button)	<p>The LCD Backlight control turns the LCD backlight off after the amount of time in Delay has expired without any screen activity.</p> <ul style="list-style-type: none"> ■ When LCD Backlight Timeout is On and the time in Delay has expired, the screen blanks out. ■ When LCD Backlight Timeout is Off, the screen display remains on.

Table 3-7: Customizable display elements

Display attribute	Access	Options
Date and Time	Display menu Objects command or Display menu Display Date & Time command or Display Setup control window Objects tab (Disp toolbar button)	Toggle the display of the date and time on the graticule. To set the time and date, use the Utilities menu Set Time & Date command.

Interpolation. When the sample density falls to less than 1 sample per display column, the oscilloscope must calculate intermediate points to display a waveform. This process is called interpolation. There are two options for interpolation:

- *Sin(x)/x interpolation* computes record points using a curve fit between the actual values acquired. It assumes all the interpolated points fall along that curve. This is particularly useful when acquiring more rounded waveforms such as sine waves. Sin(x)/x interpolation is also appropriate for general use, although it may introduce some overshoot or undershoot in signals with fast rise times.
- *Linear interpolation* computes record points between actual acquired samples by using a straight line fit. It assumes all the interpolated points fall in their appropriate point in time on that straight line. Linear interpolation is useful for waveforms with fast rise times, such as pulse trains.

For example, if an acquired record length is 500 points, a 2x zoom requires interpolation. If a record length is 100K, horizontal zoom of 200x produces 1 sample per column ($100,000/500 = 200$); therefore, you will see interpolated samples starting at the next faster scale setting.

Using the Zoom Feature

Use the oscilloscope Zoom feature to magnify an acquisition vertically, horizontally, or in both dimensions to let you see the fine detail in your signals without changing the acquisition parameters (sample rate, record length, and so on). For example, to temporarily expand the front corner of a pulse to inspect its aberrations, push the front-panel ZOOM button to expand it horizontally and vertically.

Using Zoom with Waveforms



To help you use zoom effectively, consider how it operates on waveforms.

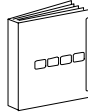

- When zooming vertically, the oscilloscope expands or contracts one waveform at a time. Also, the oscilloscope vertically positions only one waveform at a time.
- When zooming horizontally, Zoom expands either the waveform you select, all live waveforms, or all live and reference waveforms, depending on the Zoom Lock setting.
- When zooming horizontally or vertically, Zoom expands or contracts the waveform by the Zoom Scale setting.

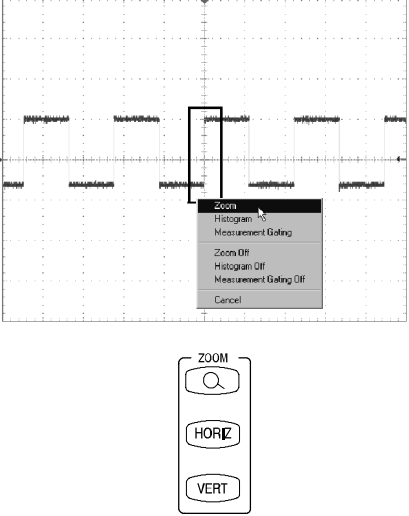
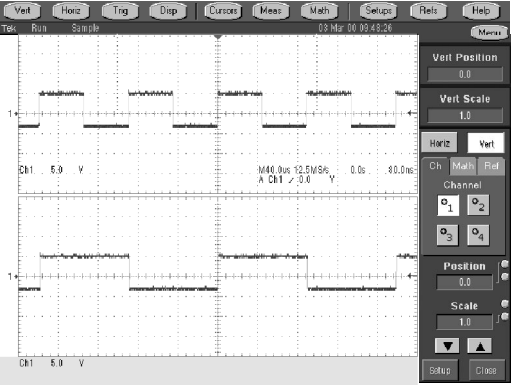
Use this procedure to zoom in on a waveform. For more information, access online help.

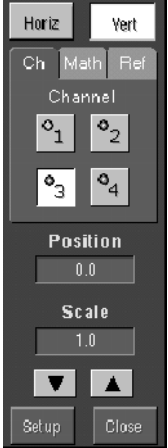
Overview	To zoom in on waveforms	Control elements and resources
<p>Prerequisites</p>	<ol style="list-style-type: none"> 1. The oscilloscope must be installed and operating, with a signal connected to an input channel, and horizontal and vertical controls and triggering set up. 2. Obtain a stable display of the waveform to be measured. 	<div style="text-align: center;">  </div> <p>See page 3-25 for acquisition setup & page 3-49 for trigger setup.</p>

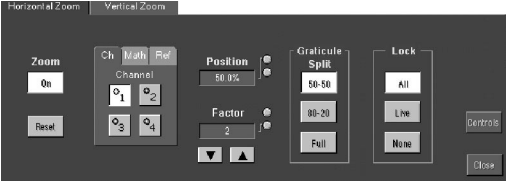
Overview	To zoom in on waveforms	Control elements and resources
<p>Select Zoom</p>	<p>3. Click with the left mouse button, and drag across the segment of the waveform that you want to see in greater detail.</p> <p>4. Release the mouse button, and select Zoom from the pop-up menu to magnify the highlighted waveform segment.</p> <p>The oscilloscope displays the zoomed area on the waveform as magnified in the bottom graticule. You can also press the front-panel ZOOM button to split the screen and add a zoom graticule.</p> <p>Each graticule uses half of the available screen display unless you change the Graticule Split in the Zoom Setup control window.</p>	 

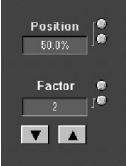
Overview	To zoom in on waveforms	Control elements and resources
<p>Focus the Zoom on waveform(s) of interest</p>	<p>5. Push the front-panel ZOOM HORIZ or VERT button to select the axis that you want to focus on in the zoom graticule. The Zoom control window opens, if it is not already present.</p> <p>6. To select the waveform that you want to scale or position, select the channel (Ch), Math, or reference (Ref) tab and then select the channel, math, or reference number of the waveform that you want to change.</p> <p>7. Use the multipurpose knobs to adjust scale and position of the zoomed waveform. Note that as you scale or move the zoomed waveform, the oscilloscope scales or moves the Zoom box relative to the unmagnified waveform.</p> <p>As you scale or move the unmagnified waveform relative to the Zoom box, the oscilloscope alters the zoomed display accordingly.</p>	 
<p>Set up Zoom options</p>	<p>8. Click Setup in the Zoom control window to open the Zoom Setup control window.</p> <p>9. Click a Graticule Split button to change the size of the unmagnified (Acquisition) and Zoom windows:</p> <ul style="list-style-type: none"> ■ 50-50 allocates half of the available display for the zoomed graticule and half of the available display for the acquisition window. ■ 80-20 allocates 80% of the available display for the zoomed graticule and 20% for the acquisition window. ■ Full uses the entire display for the zoomed graticule. <p>10. Select a Zoom Lock setting:</p> <ul style="list-style-type: none"> ■ All adjusts all waveforms at the same time. ■ Live adjusts and horizontally positions all channels and “live” math waveforms in the zoomed graticule at the same time. ■ None individually adjusts the selected waveform in the zoomed graticule. 	 

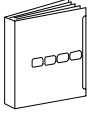
Overview	To zoom in on waveforms	Control elements and resources
<p>Check the Zoom scale and position</p>	<p>11. To quickly determine the magnification factor and position of a zoomed waveform, check the readouts on the appropriate tab (Horizontal or Vertical) of the Zoom Setup control window.</p>	
<p>Reset Zoom</p>	<p>12. To reset all Zoom settings to their defaults, click Reset on the appropriate tab (Horizontal or Vertical) of the Zoom Setup control window.</p>	
<p>For further assistance</p>	<p>13. Access the online help for more assistance on using Zoom.</p>	 <p>See <i>Accessing Online Help</i> on page 3-209 for overview of the online help system.</p>

Measuring Waveforms

The oscilloscope features cursors and automatic measurements to assist you in analyzing your waveforms. This section describes these tools:

- *Taking Automatic Measurements* describes how to set up the oscilloscope to automatically measure and display a variety of waveform parameters.
- *Taking Cursor Measurements* describes using cursors to make amplitude and timing measurements on waveforms.

NOTE. Appendix E, *Optimizing Measurement Accuracy*, describes how to run compensation routines and deskew channels to optimize measurement accuracy.

Taking Automatic Measurements

This section describes how to set up the oscilloscope to automatically take and display waveform measurements using channel, reference, and math waveforms as sources. Brief descriptions of automatic measurement features follow.

Annotated Waveforms On Screen. Use the screen text feature to mark characterization levels that each measurement uses to compute results. Figure 3-32 shows an example of a marked (annotated) waveform display. See *Customizing the Waveform Display* on page 3-106 for additional information.

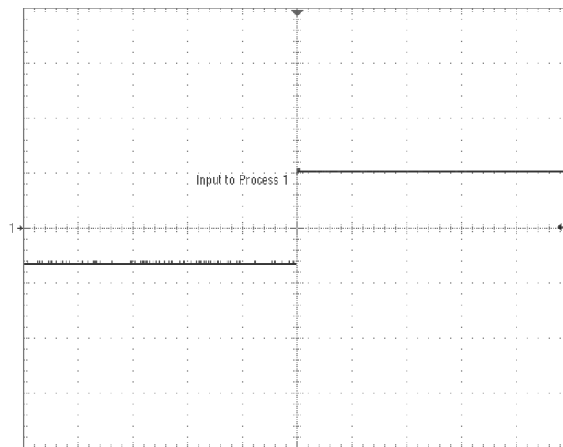

Figure 3-32: Annotated display

Customized Measurements. Choose the measurement method to control how your waveform data is characterized. See *High/Low Method* on page 3-117 and *Reference Levels Method* on page 3-117.

Statistics on Measurement Results. To see how automatic measurements vary statistically, you can display the Min, Max, Mean, and Standard Deviation of the measurement results. See *Display measurement statistics* on page 3-120 for more information.

Measurement Parameters. Select from an extensive range of parameters to measure; for a list, see *Appendix B: Automatic Measurements Supported*.

Partial Waveform Measurements. By default, the oscilloscope takes each automatic measurement over the entire waveform record, but you can use measurement gates and Zoom to localize each measurement to a section of a waveform (see *Localizing a Measurement* on page 3-122).

Take Measurements on a Frame. In FastFrame, measurements are taken only on the displayed frame.

Using Automatic Measurements

The following topics summarize how automatic measurements support your data analysis tasks. All channel, reference, and math waveforms can serve as sources for automatic measurements. Some measurements, such as Delay and Phase, require two sources.

Measurement Categories. The following automatic measurement categories are available: Amplitude, Time, More (miscellaneous), and optional Histogram. Refer to *Appendix B: Automatic Measurements Supported* for a list of the measurements you can choose from in each category.

Number of Measurements. The oscilloscope can take and update up to eight measurements at one time. You can apply measurements to any combination of sources. For example, you can take all eight measurements on Channel 1, or you can take measurements on a combination of channel waveforms, math waveforms, reference waveforms, and/or optional histograms.

High/Low Method. The levels that the automatic measurement system derives as the High (top) or Low (bottom) for a waveform influence the fidelity of amplitude and aberration measurements. Select among the modes the oscilloscope provides for determining these levels:

- *Histogram* sets the values statistically. It selects the most common value either above or below the midpoint (depending on whether it is defining the High or Low reference level). Since this statistical approach ignores short term aberrations (overshoot, ringing, and so on), Histogram is the best setting for examining pulses. See Figure 3-33.

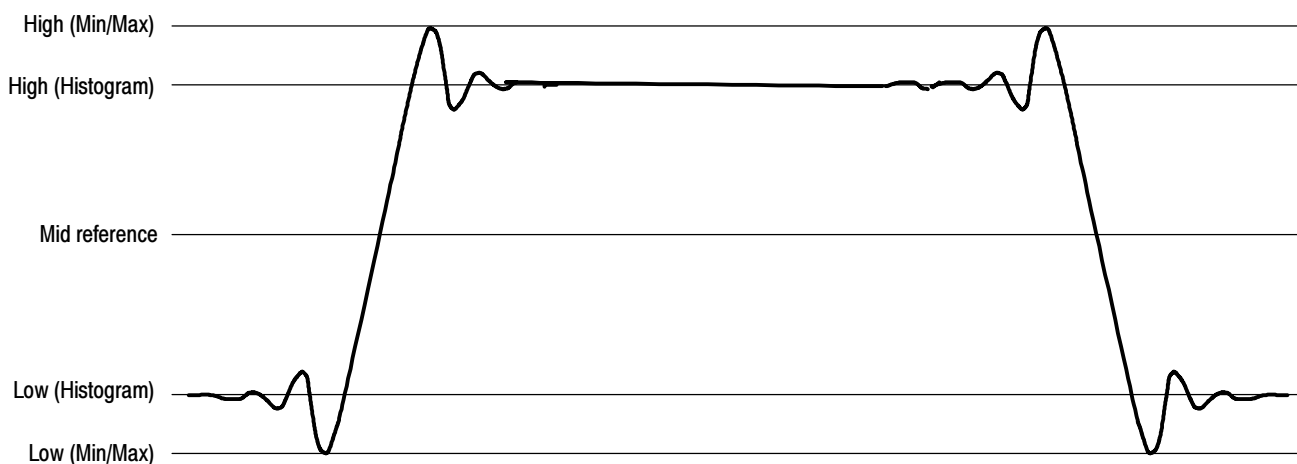

Figure 3-33: High/Low tracking methods

- *Min-Max* uses the highest and lowest values of the waveform record. This setting is best for examining waveforms that have no large, flat portions at a common value, such as sine waves and triangle waves (almost any waveform except for pulses). See Figure 3-33.

Reference Levels Method. A second set of levels affect the fidelity of time-related measurements. For example, the measurement system calculates rise time from the waveform edge that transitions from the Low to the High reference levels.

The oscilloscope provides the following calculation methods (see Figure 3-34):

1. *Relative Reference* is calculated as a percentage of the High/Low range.
2. *Absolute Reference* is set by absolute values in user units.

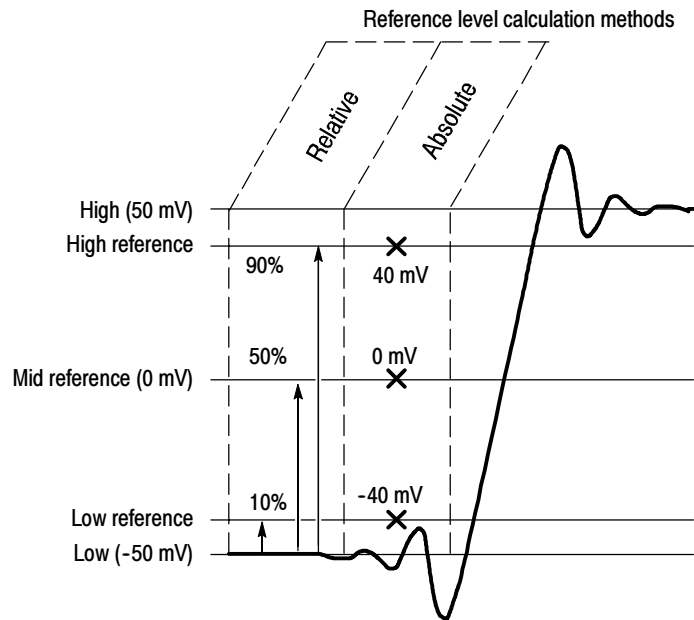
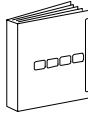

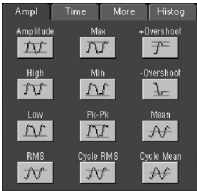
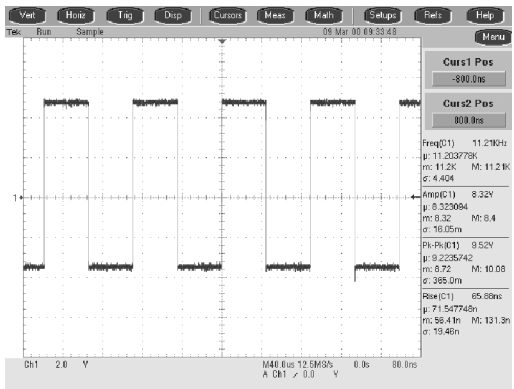

Figure 3-34: Reference level calculation methods



The High and Low levels from which the reference levels are calculated are the levels established using the selected High/Low method described on page 3-117.



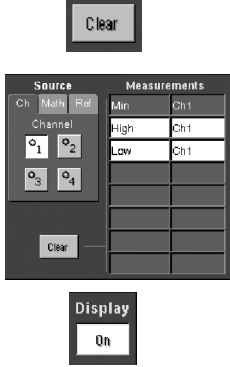
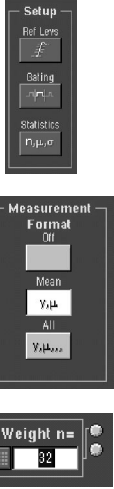

Taking Automatic Measurements

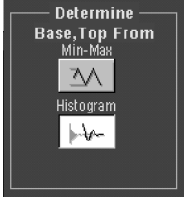
Use this procedure to quickly take a measurement based on the default settings for High and Low reference levels.

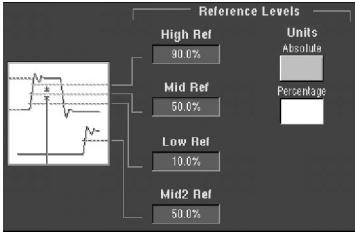

Overview	To take automatic measurements	Control elements and resources
<p>Prerequisites</p>	<ol style="list-style-type: none"> The oscilloscope must be installed and operating, with a signal connected to an input channel, and horizontal and vertical controls and triggering set up. Obtain a stable display of the waveform to be measured. 	 <p>See page 3-25 for acquisition setup & page 3-49 for trigger setup.</p>
<p>Select the source waveform</p>	<ol style="list-style-type: none"> From the toolbar, click Meas to open the Measurement Setup control window. You can use a channel, reference, or math waveform as the source. Click the appropriate waveform button on the Ch, Math, or Ref Source tab. 	
<p>Take automatic measurements</p>	<ol style="list-style-type: none"> Select the tab on the Measurement Setup control window that contains the measurement you want to take: Ampl, Time, More, or Histogram. Click the button for the measurement. For a list of the available measurements, see <i>Appendix B: Automatic Measurements Supported</i>. <p>The readout for the measurement is automatically displayed, and the measurement is added to the Measurements list in the control window.</p> <p>Measurements are displayed in the right control window area as shown here. If the window is occupied or there are too many measurements to fit in that area, the measurements are displayed in the lower graticule area.</p> <p>In roll mode, measurements are not available until after you stop acquisitions.</p>	 

Overview	To take automatic measurements	Control elements and resources
<p>Remove measurements</p>	<p>7. To remove the measurement, click Clear. The last measurement on the list is removed. To remove any measurement, click the name on the Measurements list to highlight the measurement, and click Clear. You can also click and drag to select and clear several measurements.</p> <p>8. Toggle the display of measurements on the graticule by clicking the Display button.</p>	 <p>The image shows a 'Clear' button at the top. Below it is a control panel with two main sections: 'Source' and 'Measurements'. The 'Source' section has a 'Channel' dropdown menu and four buttons labeled Q1, Q2, Q3, and Q4. The 'Measurements' section is a table with columns for 'Min' and 'Ch1'. The first row contains 'High' and 'Ch1', and the second row contains 'Low' and 'Ch1'. Below the table is another 'Clear' button. At the bottom of the panel is a 'Display' button with an 'On' indicator.</p>
<p>Display measurement statistics</p>	<p>9. From any tab on the Measurement Setup control window, click Setup Statistics. The Measurement Statistics control window opens.</p> <p>10. From the Measurement Statistics control window, click:</p> <ul style="list-style-type: none"> ■ Off to turn off measurement statistics ■ Mean to display the mean of measurements ■ All to display the Mean, Min, Max, and Standard Deviation of measurements <p>11. To set the number of measurements included in the measurement statistics, click Weight n=, and use the multipurpose knobs or pop-up keypad to set the weighting.</p>	 <p>The image shows three screenshots of control windows. The top one is the 'Setup' window with tabs for 'Ref Lines', 'Belling', 'Statistics', and 'Format'. The middle one is the 'Measurement Format' window with a 'Format' dropdown set to 'Off', a 'Mean' button, and 'All' and 'Y1,μσ' buttons. The bottom one is the 'Weight n=' window with a display showing '32' and a keypad.</p>

Overview	To take automatic measurements	Control elements and resources
<p>Set measurement reference levels</p>	<p>12. From the toolbar, click Meas to open the Measurement Setup control window.</p> <p>13. From any tab on the Measurement Setup control window, click Setup Ref Levs to open the Reference Levels setup control window.</p> <p>14. To set how the oscilloscope determines the base and top of the waveform, click Determine Base, Top From:</p> <ul style="list-style-type: none"> ■ Min-Max to use the highest and lowest values of the waveform record. See Figure 3-33. ■ Histogram to select the most common values above or below the midpoint. See Figure 3-33. <p>15. To select the reference level units, click Units:</p> <ul style="list-style-type: none"> ■ Absolute to set the units to absolute values in user units. ■ Percentage to set the units as a percentage of the High/Low range. <p>16. To set the reference levels, click on these controls and use the multipurpose knob or pop-up keypad to set:</p> <ul style="list-style-type: none"> ■ High Ref to define the high reference level. The default level is 90%. ■ Mid Ref to define the middle reference level. The default level is 50%. ■ Low Ref to define the low reference level. The default level is 10%. ■ Mid2 Ref to define the middle reference used on the second waveform specified in delay or phase measurements; the default level is 50%. 	   

Overview	To take automatic measurements	Control elements and resources
<p>Take a snapshot of measurements</p>	<p>17. Select the Snapshot command from the Measure menu, or open the Measurement Setup control window and click Snapshot on any tab. A window showing all single waveform measurements opens.</p> <p>Snapshot measurements are taken on the selected waveform. The Snapshot window tells you the channel that the measurements are being taken on and the reference levels used.</p> <p>18. Snapshot measurements are not continuously updated. To update snapshot measurements, click Snapshot Again.</p> <p>Phase, Delay, and Histogram measurements are not included in a snapshot.</p>	  
<p>For further assistance</p>	<p>19. Access the online help for more assistance on using measurements.</p> <p>20. See <i>Appendix B: Automatic Measurements Supported</i>, for a list of the measurements and their definitions.</p>	 <p>See page 3-209 to learn about using online help.</p>

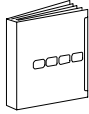
Localizing a Measurement Use this procedure to take a measurement over a segment of the waveform

Overview	To gate a measurement	Control elements and resources
<p>Prerequisites</p>	<p>1. Use the same setup as the previous procedure.</p>	 <p>See <i>Taking Automatic Measurements</i> on page 3-119</p>
<p>Access gating</p>	<p>2. From the toolbar, click Meas to open the Measurement Setup control window.</p> <p>3. Click Setup Gating from any tab. The Gating control window opens.</p>	 

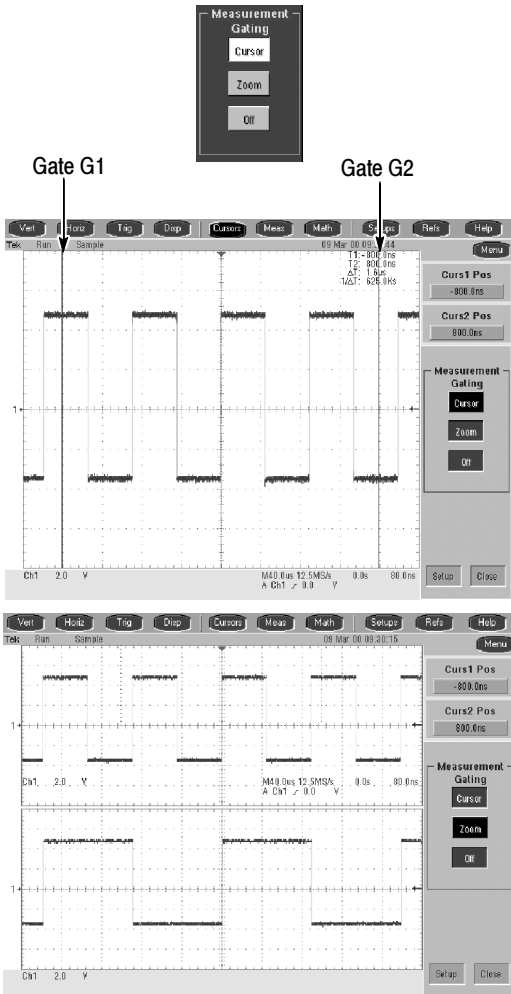
Overview	To gate a measurement	Control elements and resources
<p>Enable & position the gates</p>	<p>4. To select how to define the gated area, click Measurement Gating:</p> <ul style="list-style-type: none"> ■ Cursor to set the gated area to the area between the cursors. Use the multipurpose knobs to adjust the cursors on screen. ■ Zoom to set the gated area to the waveform area contained in the Zoom graticule. ■ Off to turn off measurement gating. You can also turn gating off from the Zoom pop-up (click and drag) window. 	

Taking Cursor Measurements

Cursor Types Because cursor measurements give immediate feedback on the amplitude or time values they measure, they are usually quick to take and are more accurate than graticule measurements. Also, since you can position cursors wherever you want them on the waveform, they are easier to localize to a waveform segment or feature than automatic measurements.

Table 3-8 defines the cursor types.

Table 3-8: Cursor types

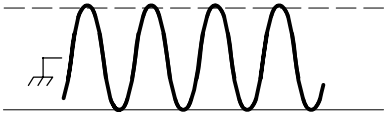
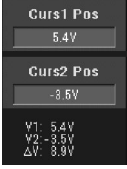
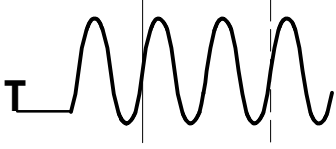
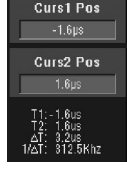
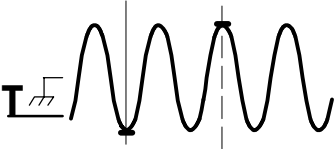
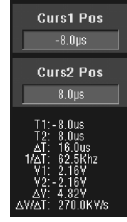
Cursor function	Measurements	Cursor readout
 <p>Horizontal cursors</p>	<p>Horizontal cursors measure vertical parameters (amplitude) in volts or watts. The cursor readouts are defined as:</p> <p>V1 = Level @ Cursor 1 with respect to its source ground level</p> <p>V2 = Level @ Cursor 2 with respect to its source ground level</p> <p>ΔV = Level @ Cursor 2 - Level @ Cursor 1</p> <p>Level is cursor displacement from the source ground multiplied by the source in volts/div. The two cursors may have different sources and therefore can have different volts/div settings.</p>	
 <p>Vertical cursors</p>	<p>Vertical cursors measure horizontal parameters. Typically the horizontal parameters are in time or frequency, but depend on the units you select. The cursor readouts are defined as:</p> <p>T1 = Time @ Cursor 1 with respect to the trigger point</p> <p>T2 = Time @ Cursor 2 with respect to the trigger point</p> <p>ΔT = Time @ Cursor 2 - Time @ Cursor 1</p> <p>Time is divisions of displacement of the cursor from its source trigger point multiplied by the source in time/div.</p>	
 <p>Paired (and Split) cursors</p>	<p>Paired cursors measure vertical parameters (typically volts) and horizontal parameters (typically time or frequency) simultaneously. Each cursor is, in effect, both a vertical and horizontal cursor. These paired cursors cannot be moved off of the waveform.</p> <p>Split cursors are the same as paired cursors except that the second cursor can be on a different waveform than the first cursor. The sources can have different volts/div settings.</p>	

Cursors can measure channel, reference, and math waveforms. You must set the source of each cursor explicitly in the Cursor Setup control window.

Cursors are not available with histograms, or in XY or XYZ display modes.

Using Cursors

To use cursors, simply move the cursors on screen and read the results in the cursor readouts. The following key points will help you use the cursors effectively.

Cursor Types. The cursor types are described in Table 3-8 on page 3-124. There are two cursors displayed for all types, Cursor 1 and Cursor 2. You can move cursors with the multipurpose knobs or the cursor position controls in the Cursor Setup control window, or click and drag them to a new location.

Cursors are Limited by the Display. You cannot move a cursor off the screen. Also, if you resize waveforms, the cursors do not track. That is, a cursor stays at its screen position, ignoring changes to horizontal and vertical scale and position and vertical offset (paired and split cursors will track a waveform vertically).

Cursors Ignore the Selected Waveform. Each cursor measures its source, defined in the Cursor Setup control window. Selecting a waveform for scaling on screen (by pushing the CH 3 front-panel button, for example) does not change the source that each cursor measures.

After you have selected the source from the Cursor Setup control window, you can operate the cursor from the front-panel knobs and buttons.

NOTE. *If a cursor readout does not seem correct, check the source of each cursor in the Cursor Setup dialog box. Each cursor readout relates to the amplitude and timebase settings of its source.*

Vertical Cursors Measure from the Trigger Point. Remember that each vertical cursor measures the time from the trigger point to itself. This relationship is shown in Figure 3-35 on page 3-126.

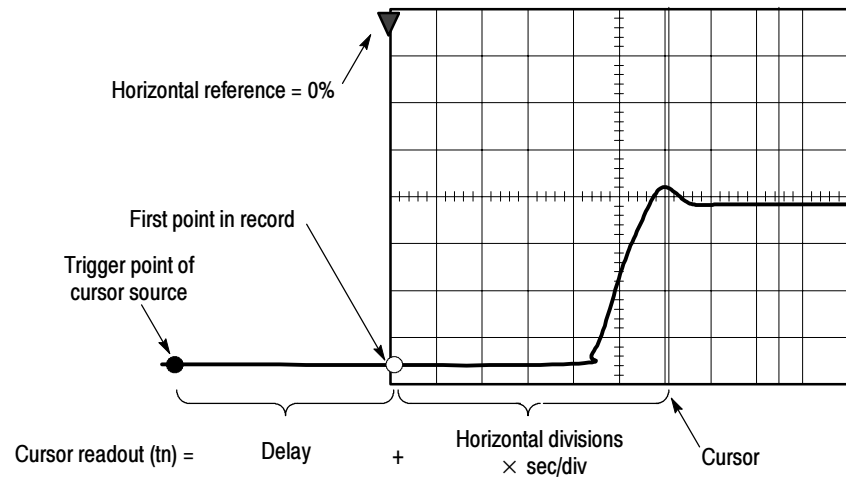

Figure 3-35: Components determining Time cursor readout values

Note that a vertical cursor readout includes and varies directly with the Delay time, which varies directly with the horizontal position set for the timebase. To see the amount of time to the first point, set horizontal delay to 0.0 and set the horizontal reference point to 0%. Now the horizontal position readout shows the time following the first point, and adding this value to the cursor readout yields the cursor position on screen relative to first point. (You can find the horizontal readout both in the control window and in the readout at the bottom of the screen.) The following relationships hold:

$$\text{Time from First Point} = \text{Horiz. Position (when Horiz. Delay and Ref Position are zero)}$$

$$T1 \text{ readout} = \text{Time to First Point} + \text{Additional Time to Cursor}$$

Cursor Units Depend on Sources. A cursor that measures amplitude or time will read out in the units of its source as indicated in Table 3-9. Note mixed sources require delta cursor readouts to use the units of the Cursor 1 source.

Table 3-9: Cursor units



Cursors	Standard units ¹	Readout names
Horizontal	volts, watts	V1, V2, ΔV
Vertical	seconds, bits	T1, T2, ΔT, F, ΔF
Paired, Split	volts, watts, seconds, bits	V1, V2, ΔV, T1, T2, ΔT



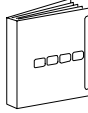

¹ If the V1 and V2 units do not match, the ΔV readout defaults to the units used by the V1 readout.

Changing Cursor Positions. Change cursor positions by using the position controls in the Cursor Setup control window, dragging the cursor into position using the touch screen or mouse, or by turning the front-panel multipurpose knobs.

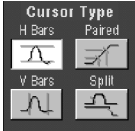
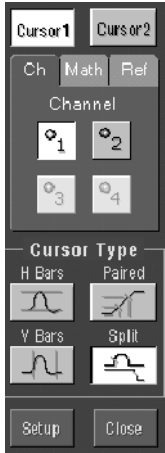
NOTE. *To make small changes with the multipurpose knobs, push the FINE button before turning the knobs. When a FINE button is lighted, its multipurpose knob makes smaller adjustments.*

Setting Cursor Sources Use this procedure to target the cursors to a source.

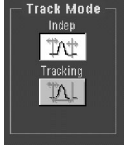
Overview	To set the cursor sources	Control elements and resources
<p>Prerequisites</p>	<p>1. Display the waveform(s) to be measured on the screen.</p>	 <p>See page 3-100 for information on displaying waveforms</p>
<p>Access cursor setup</p>	<p>2. Push the CURSORS front-panel button, or click Cursors on the toolbar to open the Cursor Type Setup control window.</p>	
<p>Select the cursor type</p>	<p>3. Click a Cursor Type button. See Table 3-8 on page 3-124 for an explanation of the cursor types.</p>	
<p>Select the cursor sources</p>	<p>4. Select a Cursor Source tab and click the channel, math, or reference waveform for which you want to take cursor measurements.</p> <p>If you are using Split cursors, click Cursor 1, and select the first source; then click Cursor 2, and select the second source.</p> <p>If a waveform is not available, its source button appears shaded.</p>	

Overview	To set the cursor sources	Control elements and resources
<p>Change the cursor position</p>	<p>5. To change the position of a cursor, use the multipurpose knobs, enter a numeric value in the <i>Cursn Pos</i> controls, or click and drag the cursors to a new position.</p>	
<p>Set cursor tracking</p>	<p>6. To change the cursor tracking mode, click Setup on the Cursor Type Setup control window. The Cursor Setup control window opens. (All adjustments that you can make in the Cursor Type Setup control window can also be made in this window.)</p> <p>7. Select a cursor Track Mode:</p> <ul style="list-style-type: none"> ■ Indep makes each cursor positionable without regard to the position of the other cursor. ■ Tracking makes both cursors move in unison and maintain a fixed horizontal or vertical distance between each other. <p>8. To toggle the display of the cursors, click the Cursor button.</p>	  
<p>For further assistance</p>	<p>9. Access the online help for more assistance on using cursors.</p>	 <p>See page 3-209 to learn about using online help.</p>

Using Histograms (Optional)

The oscilloscope can display histograms constructed from the selected waveform data. You can display both vertical (voltage) and horizontal (time) histograms, but only one at a time. Use histogram measurements to get statistical measurement data for a section of a waveform along one axis.

NOTE. Histograms are available only when you purchase the Advanced Analysis option. To upgrade your oscilloscope, purchase TDS5UP Option 2A.

The histogram source can be any channel, math, or reference waveform.

Turning on histograms starts histogram counting and data accumulation. A sample histogram display is shown in Figure 3-36. Histogram data is continuously accumulated until you explicitly turn off histograms. This allows you to continue collecting histogram data even when you turn off the histogram display.

In addition to using limit controls to set histogram box boundaries, you can also use standard Windows drag-and-drop to resize and reposition the histogram box.

Histograms are not available in FastFrame or Zoom modes.

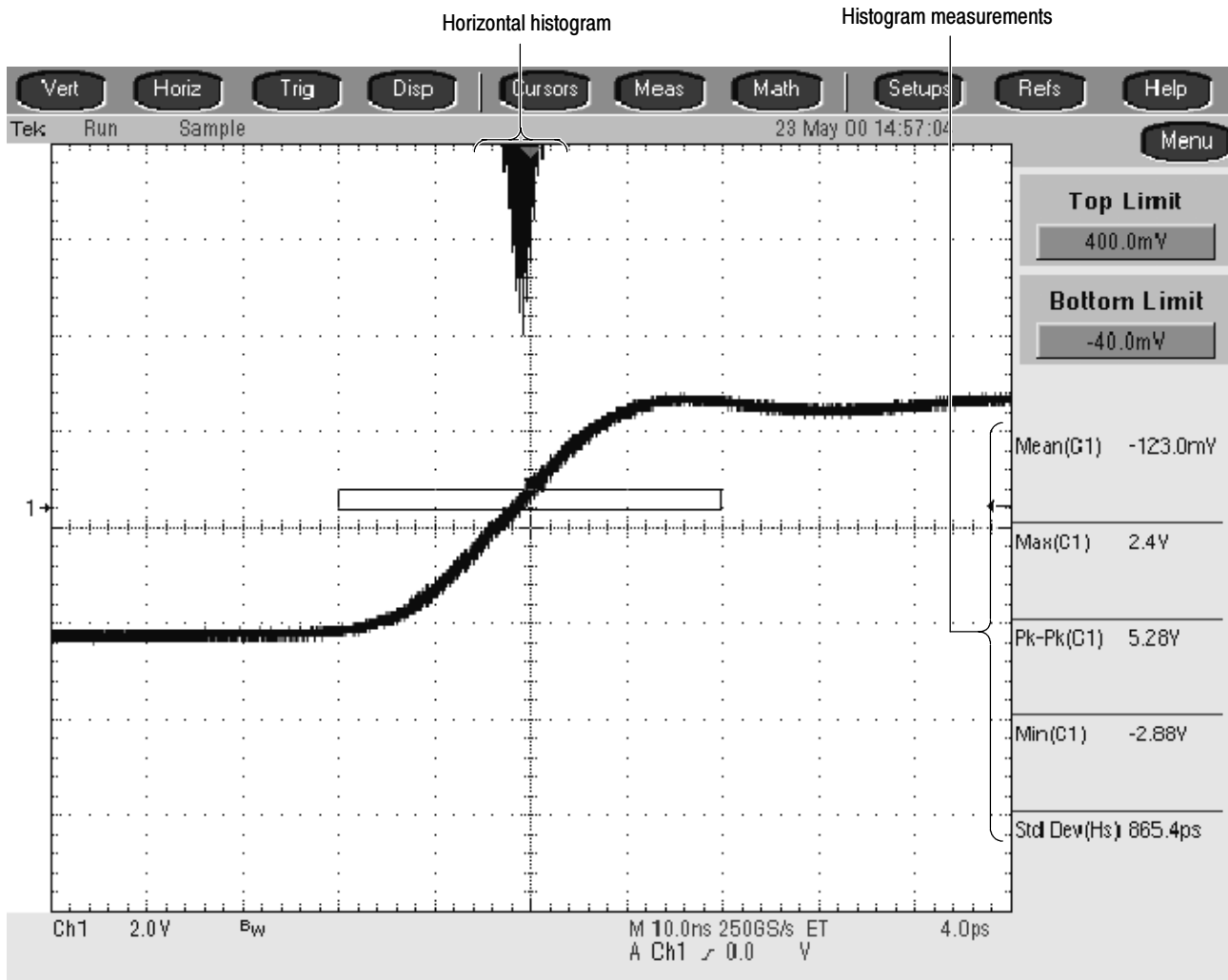
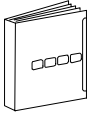





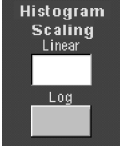
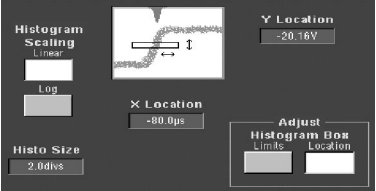

Figure 3-36: Horizontal histogram view and measurement data

Starting and Resetting Histogram Counting

Use this procedure to quickly take a measurement based on the default settings for histograms.

Overview	To start and reset histogram counting	Control elements and resources
<p>Prerequisites</p>	<p>1. Display the waveform(s) to be measured on the screen.</p>	 <p>See page 3-100 for information on displaying waveforms.</p>
<p>Open histogram setup window</p>	<p>2. From the toolbar, click the Meas button to open the Measurement Setup control window. Click Advanced to open the Histogram control window.</p>	  
<p>Set, display, and reset histogram source and type</p>	<p>3. Select either the Source Ch, Math, or Ref tab, and then select the waveform source for the histogram.</p> <p>4. Click either Histogram Mode button to start histogram counting and display the histogram data:</p> <ul style="list-style-type: none"> ■ Horiz displays a horizontal histogram that shows how time varies in the histogram box. ■ Vert displays a vertical histogram that shows how your vertical units vary in the histogram box. ■ Off turns off histogram counting and display. <p>Note that this control turns on histogram counting and data display. You can only display one type of histogram at a time.</p> <p>5. Click Reset to reset the histogram count. Histograms track numbers of counts. Clicking Reset resets those counts to zero and begins counting from zero.</p> <p>Click Display to toggle the display of the selected histogram on and off.</p>	  

Overview	To start and reset histogram counting	Control elements and resources
<p>Select histogram scale</p>	<p>6. Click a Histogram Scaling option:</p> <ul style="list-style-type: none"> ■ Linear displays histogram data linearly. Bin counts smaller than the maximum counts are scaled linearly by dividing the bin count by the maximum bin count. <p>Horizontal histograms have a maximum of 500 bins while vertical histograms have a maximum of 200 bins.</p> <ul style="list-style-type: none"> ■ Log displays histogram data logarithmically. Bin counts smaller than the maximum counts are scaled logarithmically. Logarithmic scaling provides better visual details for bins with low counts. 	
<p>Set histogram limits</p>	<p>7. Click Adjust Histogram Box Limits and use the Top Limit, Bottom Limit, Left Limit, and Right Limit controls to set the size of the histogram box. The histogram box selects the section of the waveform used for histograms.</p> <p>8. Click Adjust Histogram Box Location and use the X Location and Y Location controls to set the location of the histogram box.</p>	

Histogram Measurements

Table B-1 on page B-1 includes a list of the available histogram measurements and a brief description of each.

Creating and Using Math Waveforms

Once you have acquired waveforms or taken measurements on waveforms, the oscilloscope can mathematically combine them to create a waveform that supports your data-analysis task. For example, you might have a waveform clouded by background noise. You can obtain a cleaner waveform by subtracting the background noise from your original waveform. Or, you can integrate a single waveform into an integral math waveform as is shown below.

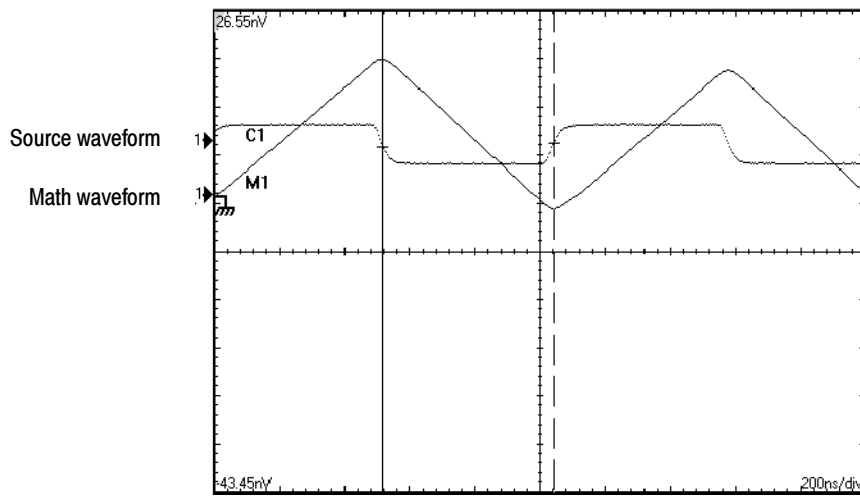

Figure 3-37: Math waveform created from source waveform

With spectral analysis you can analyze waveforms in the frequency domain. The interface is similar to a dedicated spectrum analyzer, so you do not need to know the details of the underlying algorithms (see Figure 3-38).

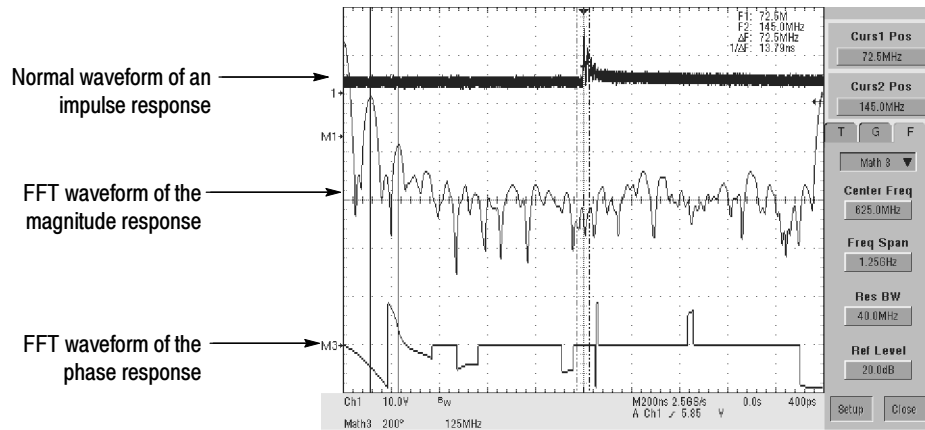

Figure 3-38: Spectral analysis of an impulse

About Math Waveforms

Purpose This oscilloscope supports mathematical combination and functional transformations of waveforms it acquires. Figure 3-39 shows this concept:

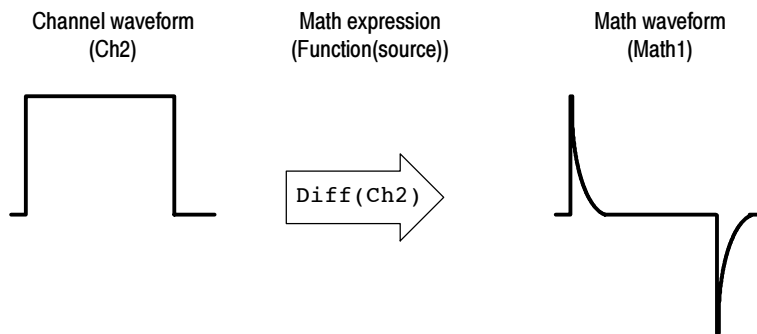

Figure 3-39: Functional transformation of an acquired waveform

NOTE. Some of the math functions are only available if you purchase and install TDS5UP Option 2A, Advanced Analysis (see Table 3-10).

You create math waveforms to support the analysis of your channel and reference waveforms. By combining and transforming source waveforms and other data into math waveforms, you can derive the data view that your application requires. Create math waveforms that result from:

- Mathematical operations on one or several waveforms: add, subtract, multiply, and divide.
- Functional transformations of waveforms, such as integration, differentiation, and so on.
- Spectral analysis of waveforms, such as testing impulse response.

You can create up to four math waveforms (two for the TDS5052); see *Using Math* on page 3-138 for more examples.

**Standard Math versus
Advanced Math**

Table 3-10 shows the functions available with the standard (default) math capabilities of this instrument versus the functionality provided when TDS5UP Option 2A, Advanced Analysis, is installed. Note that 2A also includes histograms, which are discussed in the previous section (*Measuring Waveforms*).

Table 3-10: Functions available in Standard Math and Advanced Math

Standard Math	Advanced Math
Math Waveform Positioning <ul style="list-style-type: none"> ■ Vertical position and scale ■ Display on/off ■ Labeling 	Math Waveform Positioning <ul style="list-style-type: none"> ■ Vertical position and scale ■ Display on/off ■ Labeling
Waveform Math Operations <ul style="list-style-type: none"> ■ Dual waveform math 	Waveform Math Operations <ul style="list-style-type: none"> ■ Equation Editor ■ Averages ■ Predefined expressions
FFT Math Operations <ul style="list-style-type: none"> ■ Magnitude 	FFT Math Operations <ul style="list-style-type: none"> ■ Advanced spectral analysis (magnitude, phase, averaging) ■ Locking spectral controls ■ Gating with FFT window types

Other Uses for Math Waveforms

Measurement scalars can be used in math expressions. For example, you can measure the average of a waveform (using the measurement capabilities of the instrument) and subtract it from the original waveform to define a new math waveform. Measurements 1 through 8 are allowed in a math definition, but not measurement functions (such as rise(Ch1)).

In FastFrame, math is applied to each frame.

Some operations that you cannot use with math waveforms are:

- *Circular Math-on-Math, Measurements in Math, and Measurements on Math:* You cannot use circular definitions of math waveforms. For example, if you define Math2 = Ch1 - Math1, and then define a second math waveform as Math3 = Ch2 + Math2, you cannot define a third math waveform as Math1 = Math2 + Ch3. If you do, the Math1 definition is rejected with an error because a circular definition is not allowed.
- *Fast Acquisitions:* Math is not allowed in Fast Acquisitions mode.
- *Roll Mode:* Math is not allowed in roll mode until you push STOP.
- *Different Length Sources:* If you use two waveforms (channel and reference waveforms) of different lengths, the length of the math waveform will be the shorter of the two lengths.

Using Math

The following topics provide details about creating math waveforms.

Creating Math Waveforms. You create math waveforms when you create a math expression. You do so by applying numerical constants, math operators and functions to operands (see *Sources* on the following page). You can display and manipulate these derived math waveforms much like you can the channel and reference waveforms (see *Operations on Math Waveforms* on page 3-147).

Some examples of typical math waveforms follow:

Table 3-11: Math expressions and the math waveforms produced

To . . .	Enter this math expression. . .	and get this math waveform. . .
normalize a waveform 	. . . $(Ch1 - Meas1) / Meas2$, where Ch1 is the waveform shown at left Meas1 = Low of Ch1 Meas2 = amplitude of Ch1	shifted and scaled to fit a template 

Table 3-11: Math expressions and the math waveforms produced (Cont.)

To . . .	Enter this math expression. . .	and get this math waveform. . .
simulate AC coupling 	. . . $\text{Intg}(\text{Ch1} - \text{Avg}(\text{Ch1}))$, where Ch1 is the waveform shown at left Avg is the average function	AC component removed before integration 

Sources. Math waveforms can be created from:

- Channel waveforms
- Reference waveforms
- Measurement scalars (automated measurements) that measure channel, reference, or math waveforms, or histograms.
- Math waveforms

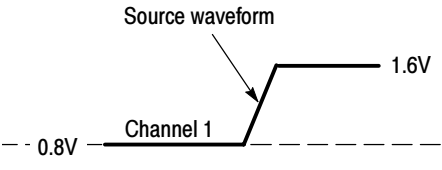
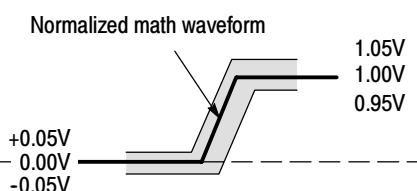
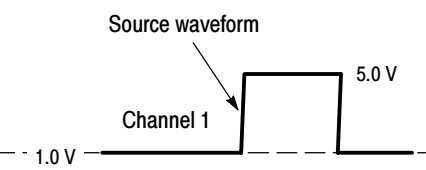
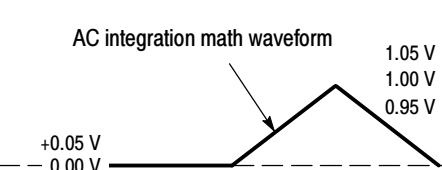
Source Dependencies. In general, math waveforms that include sources as operands are affected by updates to those sources:

- Shifts in amplitude or DC level of input sources that cause the source to clip also clip the waveform data supplied to the math waveform.
- Changes to the vertical offset setting for a channel source that clip its data also clip the waveform data supplied to the math waveform.
- Changes to the acquisition mode globally affects all input channel sources, modifying any math waveforms using them. For example, with the acquisition mode set to Envelope, a $\text{Ch1} + \text{Ch2}$ math waveform will receive enveloped channel 1 and channel 2 data, and will also be an envelope waveform.
- Clearing the data in a waveform source causes a baseline (ground) to be delivered to any math waveform that includes that source until the source receives new data.

Expression Syntax. Build math waveforms using the Dual Waveform Math controls (standard math) or the Equation Editor control window (advanced math). To help you create valid math waveforms, these tools block most illegal entries by disabling any window element that would create an invalid entry in the math waveform expression.

Basic dual waveform math is performed from the Math Setup control window by simply selecting the first waveform, the operand, and the second waveform. Click Apply to display the math waveform in the graticule.

The syntax that follows describes valid math expressions for advanced math using the Equation Editor:

```

<MathWaveform> := <Expression>

<Expression> := <UnaryExpression> | <BinaryExpression>

<UnaryExpression> := <UnaryOperator> ( <Term> )
                  | <UnaryOperator> ( <Expression> )

<BinaryExpression> := <Term> <BinaryOperator> <Term> | <Scalar>
                   <BinaryOperator> <Term> | <Term> <BinaryOperator> <Scalar>

<Term> := <Waveform> | ( <Expression> )

<Scalar> := <Integer> | <Float> | <Meas-Result>

<Waveform> := <ChannelWaveform> | <ReferenceWaveform> | <MathWaveform>

<ChannelWaveform> := Ch1 | Ch2 | Ch3 | Ch4

<ReferenceWaveform> := Ref1 | Ref2 | Ref3 | Ref4

<MathWaveform> := Math1 | Math2 | Math3 | Math4

<UnaryOperator> := Invert | Derivative | Integral | Average | Max | Min
                 | Filter | Vmag | Exp | log 10 | log e | sqrt | Spectral Magnitude
                 | Spectral Phase | Spectral Real | Spectral Imag

<BinaryOperator> := + | - | / | *

<Meas-Result> := meas1 | meas2 | meas3 | meas4 | meas5 | meas6 | meas7 | meas8
    
```

Waveform Differentiation. The advanced math capabilities of the oscilloscope include waveform differentiation. This allows you to display a derivative math waveform that indicates the instantaneous rate of change of the waveform acquired.

Derivative waveforms are used in the measurement of slew rate of amplifiers and in educational applications. You can create a derivative math waveform and then use it as a source for another derivative waveform. The result is the second derivative of the waveform that was first differentiated.

The math waveform, derived from the sampled waveform, is computed based on the following equation:

$$Y_n = (X_{(n+1)} - X_n) \frac{1}{T}$$

- Where:
- X is the source waveform
 - Y is the derivative math waveform
 - T is the time between samples

Since the resultant math waveform is a derivative waveform (See Figure 3-40), its vertical scale is in volts/second (its horizontal scale is in seconds). The source signal is differentiated over its entire record length; therefore, the math waveform record length equals that of the source waveform.

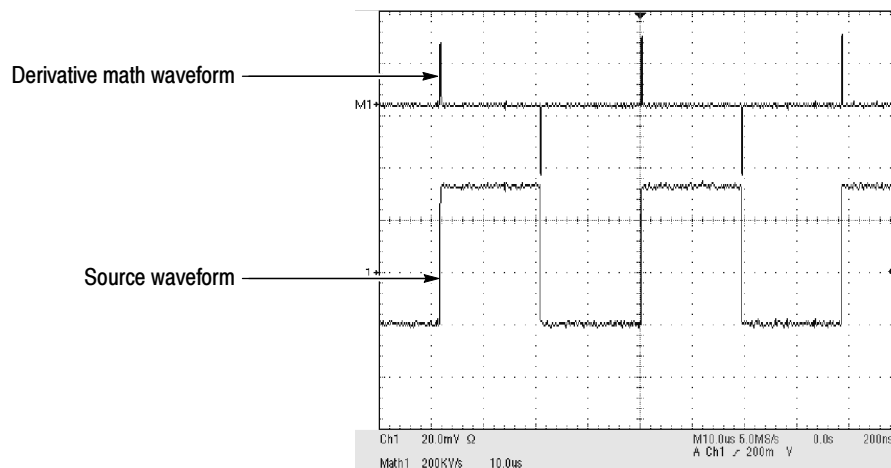

Figure 3-40: Derivative math waveform

Cursor Measurements. You can also use cursors to measure derivative waveforms. Use the same procedure as *Take Cursor Measurements* on page 3-150. When using that procedure, note that the amplitude measurements on a derivative waveform will be in volts per second rather than in volt-seconds as is indicated for the integral waveform measured in the procedure.

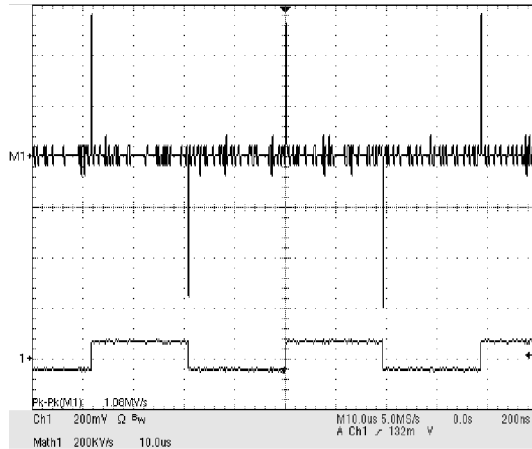

Figure 3-41: Peak-peak amplitude measurement of a derivative waveform

Offset, Position, and Scale. The settings that you make for offset, scale, and position affect the math waveform you obtain. Here are some tips for obtaining a good display:

- Scale and position the source waveform so that it is contained on the screen. (Off-screen waveforms may be clipped, resulting in errors in the derivative waveform).
- Use vertical position and vertical offset to position your *source* waveform. The vertical position and offset will not affect your derivative waveform unless you position the source waveform off of screen so that it is clipped.

Waveform Integration. The advanced math capabilities of the oscilloscope include waveform integration. This allows you to display an integral math waveform that is an integrated version of the acquired waveform.

Use integral waveforms in the following applications:

- Measuring power and energy, such as in switching power supplies.
- Characterizing mechanical transducers, as when integrating the output of an accelerometer to obtain velocity.

The integral math waveform, derived from the sampled waveform, is computed based on the following equation:

$$y(n) = scale \sum_{i=1}^n \frac{x(i) + x(i-1)}{2} T$$

Where: $x(i)$ is the source waveform
 $y(n)$ is a point in the integral math waveform
scale is the output scale factor
 T is the time between samples

Since the resultant math waveform is an integral waveform, its vertical scale is in volt-seconds (its horizontal scale is in seconds). The source signal is integrated over its entire record length; therefore, the math waveform record length equals that of the source waveform.

Offset and Position. When creating integrated math waveforms from live channel waveforms, consider the following topics:

- You should scale and position the source waveform so that it is contained on screen. (Off screen waveforms may be clipped, which will result in errors in the integral waveform).
- You can use vertical position and vertical offset to position your source waveform. The vertical position and vertical offset will not affect your integral waveform unless you position the source waveform off screen so that it is clipped.

DC Offset. The source waveforms that you connect to the oscilloscope often have a DC offset component. The oscilloscope integrates this offset along with the time-varying portions of your waveform. Even a few divisions of offset in the source waveform may be enough to ensure that the integral waveform saturates (clips), especially with long record lengths.

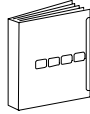
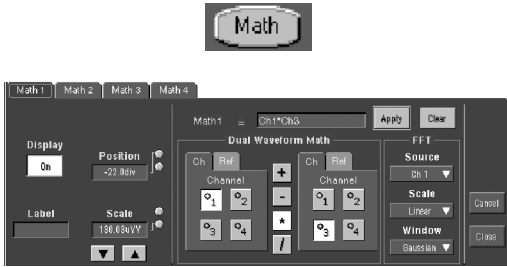
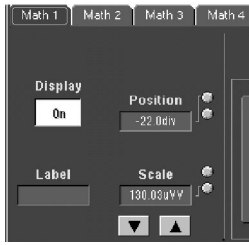
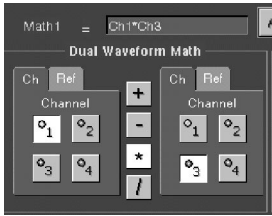
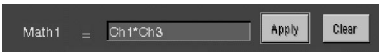

Creating a Math Waveform Use this procedure to create a math waveform using Dual Waveform math. If you have purchased the Advanced Analysis option (TDS500UP Option 2A), use the subsequent procedure beginning on page 3-145.

Overview	To create a math waveform	Control elements and resources
<p>Prerequisites</p>	<p>1. All waveforms that you want to use must be available.</p>	 <p>See page page 3-25 for acquisition setup</p>
<p>Open the Math Setup control window</p>	<p>2. From the toolbar, click the Math button to open the Math Setup control window.</p>	
<p>Select a math waveform</p>	<p>3. Select the Mathn tab for the math waveform that you want to create, and click Display to toggle it on.</p> <p>Tip. If the waveform you select already exists, its math expression appears in the window. You can still use the waveform by clicking Clear, which discards the previous math expression. You may also want to select another waveform.</p>	
<p>Enter an expression</p>	<p>4. Enter a complete math expression by selecting a channel or reference waveform as the left operand, selecting an operator, and selecting another channel or reference waveforms as the right operand. The left channel selector tabs are always assigned to the first waveform and the right channel selector tabs are always assigned to the second waveform.</p> <p>Note that you cannot use a math waveform as an operand in any expression.</p>	
<p>Apply expression to waveform</p>	<p>5. Once you have defined the math expression to your satisfaction, click Apply.</p>	



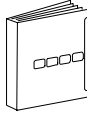
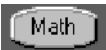

Overview	To create a math waveform	Control elements and resources
For further assistance	6. Access the online help for more assistance on using math waveforms.	 <p>See <i>Accessing Online Help</i> on page 3-209 for overview of the online help system.</p>

Creating a Math Waveform (Optional)

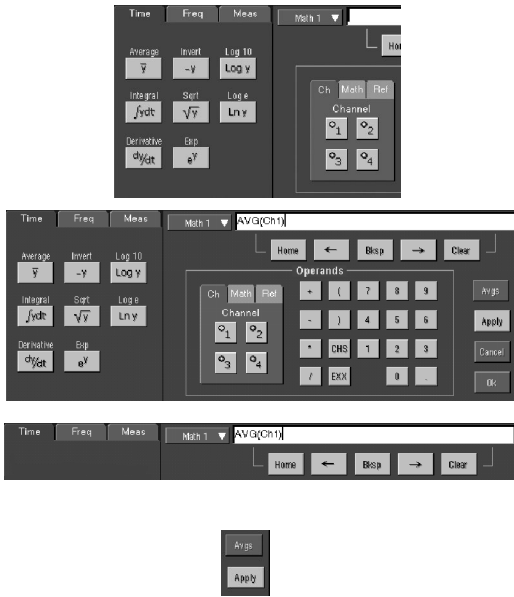
Use this procedure to create a math waveform using the Advanced Analysis option. Ensure that the sources you want to use exist. The sources do not have to be displayed.

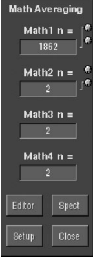
Overview	To create a math waveform	Control elements and resources
Prerequisites	1. All waveforms and automatic measurement scalars that you want to use must be available.	 <p>See page page 3-25 for acquisition setup</p>
Open the Math Setup control window	2. From the toolbar, click the Math button to open the Math Setup control window.	
Select a math waveform	3. Select the Math n tab for the math waveform that you want to create, and click Display to toggle it on. Tip. If the waveform you select already exists, its math expression appears in the window. You can still use the waveform by clicking Clear, which discards the previous math expression. You may also want to select another waveform.	
Select an expression	4. Click one of the Predefined Expression buttons to use a predefined math expression, or click Editor to access the Equation Editor.	

Overview	To create a math waveform	Control elements and resources
<p>Define or edit an expression</p>	<p>5. Use the Equation Editor control window to define a math expression. See Table 3-11 on page 3-138 for examples, and use these guidelines:</p> <ul style="list-style-type: none"> ■ Math definitions are not implemented if the sources are not valid. ■ Use the Bksp (backspace) button to remove the last entry; click Clear to remove the entire expression and start over. ■ Use parentheses to group terms in the expression to control execution order, for example, 5(Ch1 + Ch2). 	
<p>Select a function, build an expression, and apply to the waveform</p>	<p>6. Select the Time, Freq, or Meas tabs to display the available functions.</p> <p>7. Click a function button to enter the function in the math expression. Click an operand button (+, -, *, /) to insert an operand.</p> <p>8. Use the Home and arrow buttons to move within the math expression. Use the Bksp (backspace) button to delete portions of the expression.</p> <p>9. Click Apply to apply your new math expression to the math waveform.</p>	

Overview	To create a math waveform	Control elements and resources
<p>Apply averaging</p>	<p>10. Click Avgs to open the Math Parameters control window. The controls in the window apply to the math waveform defined by the expression.</p> <p>11. Select one of the Mathn = controls, and set the number of averages using the multipurpose knobs or pop-up keypad. This number of averages affect math waveforms if the Avg() function is used.</p>	 
<p>Apply expression to waveform</p>	<p>12. Once you have defined the math expression to your satisfaction, click Apply. Apply is available on the Equation Editor and Spectral Setup control windows.</p>	
<p>For further assistance</p>	<p>13. Access the online help for more assistance on using math waveforms.</p>	 <p>See <i>Accessing Online Help</i> on page 3-209 for overview of the online help system.</p>

Operations on Math Waveforms

This oscilloscope supports many of the same operations for math waveforms that it provides for channel (live) and reference waveforms. For example, you can measure math waveforms with cursors. This section discusses:

- Vertical display scaling and positioning
- Taking automatic measurements
- Taking cursor measurements
- Using histograms (optional)

In addition to the operations listed above, you can save math waveforms as reference waveforms.





NOTE. Each math waveform that you create derives its horizontal scale and position from the sources you include in its math expression. You can adjust these controls for the source waveforms and your adjustments are reflected in the math waveform. You can also magnify math waveforms using Zoom, and use the mouse for positioning.

Displaying and Measuring Math Waveforms

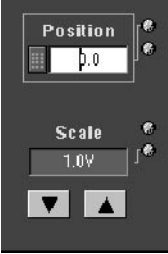
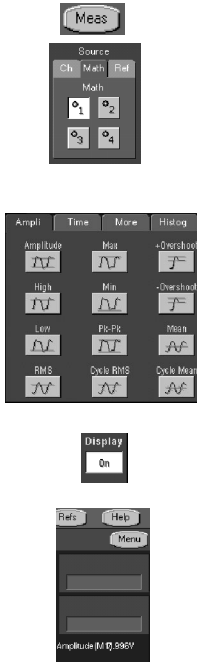
Basically, you use the same techniques to work with math waveforms that you use with channel waveforms. This procedure demonstrates some common operations you can perform on math waveforms:

Overview	To use math waveforms	Control elements and resources
<p>Prerequisites</p>	<p>1. A math waveform must be defined and displayed.</p>	<div data-bbox="1149 808 1242 919" data-label="Image"> </div> <p>See <i>Creating a Math Waveform</i> on page 3-144 or page 3-145</p>
<p>Select and display</p>	<p>2. Click the Math toolbar button to open the Math Setup control window.</p> <p>3. Select the tab for the math waveform that you want to work with.</p> <ul style="list-style-type: none"> ■ If the waveform you select is not defined, use the <i>Creating a Math Waveform</i> procedure starting on page 3-144 or page 3-145 to define the math waveform. ■ If the waveform is not displayed, click Display. 	<div data-bbox="1063 1050 1323 1407" data-label="Image"> </div>

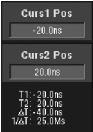
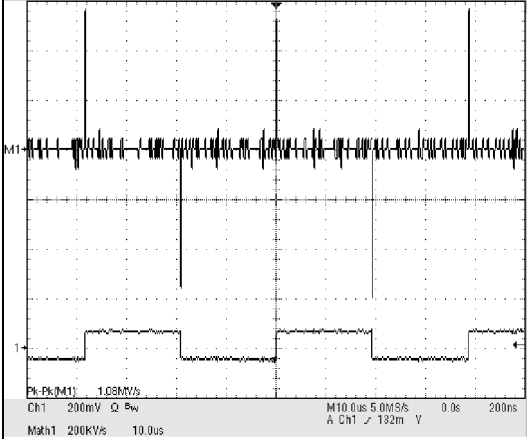
Overview	To use math waveforms	Control elements and resources
<p>Set scale and position</p>	<p>4. Click Position and Scale and use the multipurpose knobs or pop-up keypad to size and position the waveform on the screen.</p> <p>Keep in mind the following:</p> <ul style="list-style-type: none"> ■ The position is in divisions, so changing the scale can make the math waveform disappear until position is also changed (the same effect happens with channel waveforms). ■ You can click and drag a waveform handle to change the waveform vertical position. ■ You can change the waveform vertical position and scale by clicking on the waveform handle and using the multipurpose knobs to adjust. ■ You cannot adjust the offset of a math waveform. ■ You cannot adjust horizontal scale, position, and sample density (resolution) of math waveforms; different length source waveforms result in a math waveform of the shortest source record length. If you adjust these settings for sources of a math waveform, the adjustments are reflected in the math waveform. 	
<p>Take automatic measurements</p>	<p>5. Click the Meas toolbar button to open the Measurement Setup control window.</p> <p>6. Select the Source Math tab, and click a channel button to choose a math waveform.</p> <p>7. Select a measurement (for more information, see <i>Taking Automatic Measurements</i> on page 3-115).</p> <p>Tip. Click the Help button in the menu bar for more information.</p> <p>8. To display the measurement, touch Display to toggle it to on.</p> <p>9. Read the results in the measurements readout.</p>	

Overview	To use math waveforms	Control elements and resources
<p>Take cursor measurements</p>	<ol style="list-style-type: none"> 10. Click the Cursor toolbar button to display the cursors and open the Cursor control window. 11. Select the Math tab, and click the numbered button for the math waveform that you want to measure. 12. Select the cursor type by clicking either H Bars, V Bars, Paired, or Split (for more information, see <i>Taking Cursor Measurements</i> starting on page 3-124). 13. Use the multipurpose knobs to position each cursor on the math waveform to measure the feature that interests you. 14. Read the results in the cursor readout. The cursor readout is displayed under the multipurpose readouts or in the upper right corner of the graticule area. <p>Note that amplitude measurements on a derivative waveform are in volts per second, and volt-seconds for an integral waveform measurement.</p>	   
<p>For further assistance</p>	<ol style="list-style-type: none"> 15. Access the online help for more assistance on math waveforms operations. 	 <p>See <i>Accessing Online Help</i> on page 3-209 for overview of the online help system.</p>

Defining Spectral Math Waveforms

The math capabilities of the oscilloscope include waveform spectral analysis. This section describes how you can control the analysis intuitively with time domain and frequency domain controls. These controls merge the time domain controls with the frequency domain controls to provide a complete spectral analyzer.

NOTE. *This type of advanced spectral analysis is only available if you purchase Option 2A, Advanced Analysis. The math capabilities that come standard with this oscilloscope allow you to define a scale and window type to create an FFT magnitude spectrum.*

Signals may be represented by their characteristics in both the time and the frequency domain. By combining and transforming source waveforms into spectral math waveforms, you can simultaneously view signal characteristics in both domains.

This spectral analyzer provides a complete set of controls and features that allow you to make time and frequency domain measurements without the need to learn extensive details about FFT algorithms.

- *Frequency Domain Controls:* Use traditional spectrum analyzer controls to set the center frequency, span, and resolution bandwidth directly.
- *Time Domain Controls:* The time domain controls for the acquired waveform set the time duration and the resolution time between samples. You can easily set the required sample rate and record length.
- *Gating Controls:* These controls are the bridge that connects the time domain to the frequency domain. You can perform spectral analysis on a gated region of the input waveform. This gating also determines the resolution bandwidth.
- *Window Functions:* Eight different window functions are available to shape the filter response.
- *Magnitude Versus Frequency:* Display log data in dB, dBm, or linear mode. You can display the real or imaginary parts of the spectral magnitude only. Reference level offset and reference level controls give complete control over the vertical position and offset of the spectrum.
- *Phase Versus Frequency:* Display phase data as a function of frequency in radians or degrees. You may zero the noise phase for magnitudes below a threshold level. Finally, you may select Phase unwrap and $d\theta/d\omega$, group delay.
- *Spectral Averaging:* You can turn on averaging in the frequency domain for phase and magnitude waveforms.

- **Multiple Analyzer Control Locks:** Up to four spectral analyzers may be used simultaneously. They may all be assigned to different gates on the same source waveform or to different channel sources. The controls of Math1 and Math2 may be locked, and the controls of Math3 and Math4 may be locked. When controls are locked, turning a control on one analyzer changes the control on the other analyzer to the same value. Other combinations of locking, including all four analyzers, are available using GPIB commands.

The same exclusions for math waveforms apply to spectral math waveforms. In addition, *sources for spectral math waveforms must be channel waveforms.*

Using Spectral Math Controls

Read these topics for information on creating spectral waveforms.

The spectral analyzer contains five primary control categories. These are shown in Table 3-12.

Table 3-12: Spectral analyzer controls

Time controls	Gate controls	Frequency controls	Magnitude controls	Phase controls
Source	Position	Center	dB, dBm linear, real imaginary	degrees, radians, group delay
Duration, record length	Duration	Span	Ref level	Zero threshold
Duration, sample rate	Window	Resolution bandwidth	Ref level offset	Phase Unwrap
Resolution				

Using the time controls. The operation of the time domain controls for the spectral analyzer is summarized by the following rules:

- Duration selects the time from the beginning to the end of the acquired waveform. You may set duration using the record length control or the sample rate control.
- Resolution determines the time between samples. Duration is kept constant as resolution is changed. Therefore, the Resolution control affects both the sample rate and the record length simultaneously.
- Most often, you will want to use a short record length because long record lengths can slow oscilloscope response. However, long record lengths lower the noise relative to the signal and increase the frequency resolution for the spectral math waveform. More importantly, they might be needed to capture the waveform feature that you want to include in the waveform.

Examples of how duration and resolution affect the acquired waveform are shown in Figure 3-42.

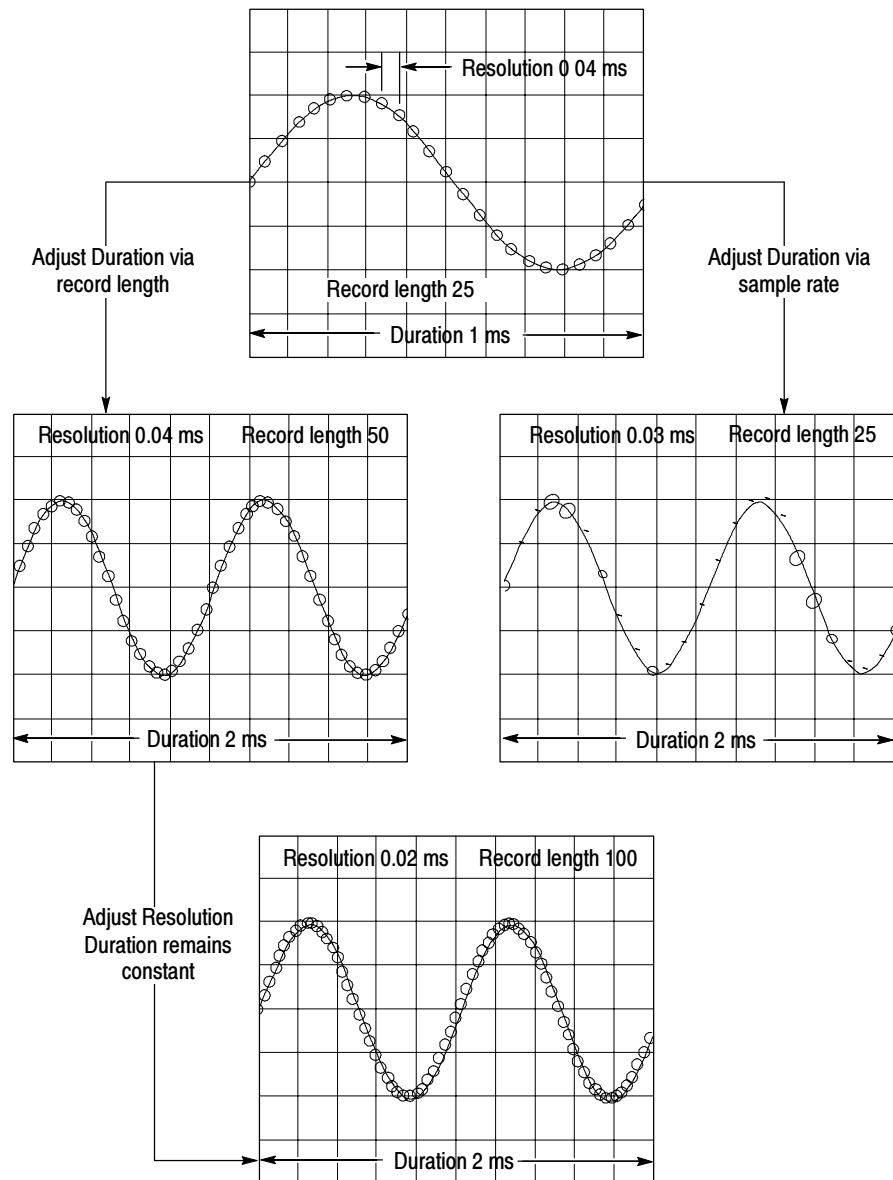

Figure 3-42: Duration and resolution control effects

Using gating controls. Gating determines which portion of the acquired waveform is transformed into the frequency domain. The gate has a position and a width control.

The gate position is the time in seconds from the trigger location to the center 50% position of the gate interval (see Figure 3-43). The position and width units are seconds.

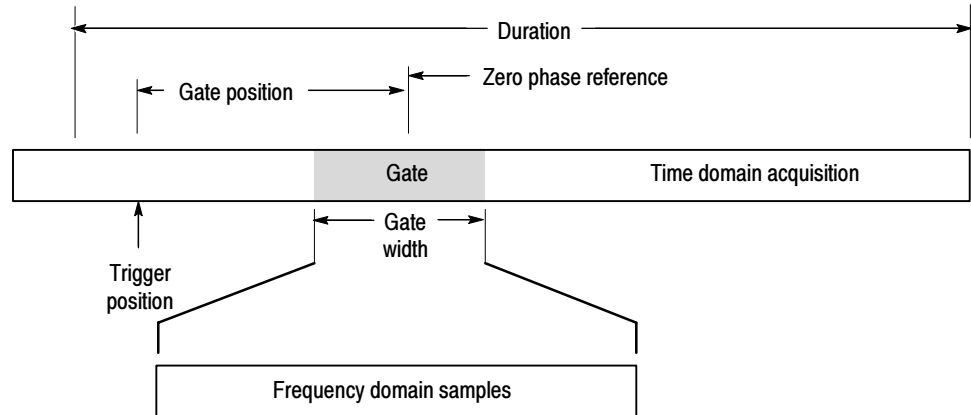

Figure 3-43: Definition of gate parameters

The gate must reside within the duration interval of the source waveform. If the source waveform duration is adjusted, and the gate position and width would result in the gate being outside of that duration, then the gate position or width is set within the limits.

The width of the gate affects the resolution bandwidth of the spectral analyzer. See *Using Spectral Math Controls* on page 3-152 for more details.

The data contained in the gated region is transformed to the frequency domain.

The gate is identified on the display using dashed markers (similar to cursors). The default gate width setting is equal to the duration of the source waveform.

Using the Frequency Domain controls. The gated region of the source waveform is transformed into a spectral phase or magnitude waveform. The horizontal units are always Hz. The vertical units depend on whether phase or magnitude is selected. The frequency domain controls for the spectral waveform are span, center, and resolution bandwidth. The spectrum normally appears on the display fit to a screen width of 10 divisions.

Span is the frequency at the end of the spectral waveform minus the frequency at the beginning of the waveform. The span control maximum value is equal to the current sample rate divided by two. Therefore, if you are unable to increase the span to the desired value and if you want to keep the same source waveform duration, go to the timebase controls and increase the sample rate using the resolution control. Or, if you want to also decrease the source waveform duration, adjust the sample rate control. If you decrease the sample rate, the span setting may decrease, if necessary, to keep the span less than the sample rate divided by two.

Center: This is the frequency at the center of the spectral waveform. Center is equal to the start frequency plus one half of the span. The adjustment range depends on the sample rate and the current span setting. Remember that the span must always be in the interval of zero to one half of the sample rate. Therefore, if the span is set to full, the center frequency control will not have any adjustment range and will remain at one half of the sample rate. It is necessary to decrease the span before the center will have an adjustment range. If you are unable to increase the center to the desired value, increase the sample rate using either the sample rate or resolution controls. You may also change sample rate by using the HORIZONTAL SCALE knob on the oscilloscope front panel.

Resolution Bandwidth, RBW: This is the 3 dB down bandwidth of the spectral analyzer frequency response to a sine wave input. The resolution bandwidth is affected by two parameters:

- Different window functions produce different filter response shapes in the spectrum and result in different resolution bandwidths.
- The gate width of the input data affects the RBW. Gate width has units of seconds. The RBW directly controls the gate width, but the numerical value is entered in units of Hz. Therefore, the time domain gate markers move as you adjust the RBW control.

$$RBW = \frac{\text{Window Bin Width}}{\text{Gate Width}}$$

The *Window Bin Width* is the resolution bandwidth in units of bins, and depends on the window function in use. The *Gate Width* is in units of seconds.

Figure 3-44 demonstrates the effects of adjusting the center frequency and span. Center frequency is a horizontal position control for the spectrum. Span is a horizontal scale control. Resolution bandwidth adjusts the bandwidth of the analyzer filters without affecting the span and center frequency.

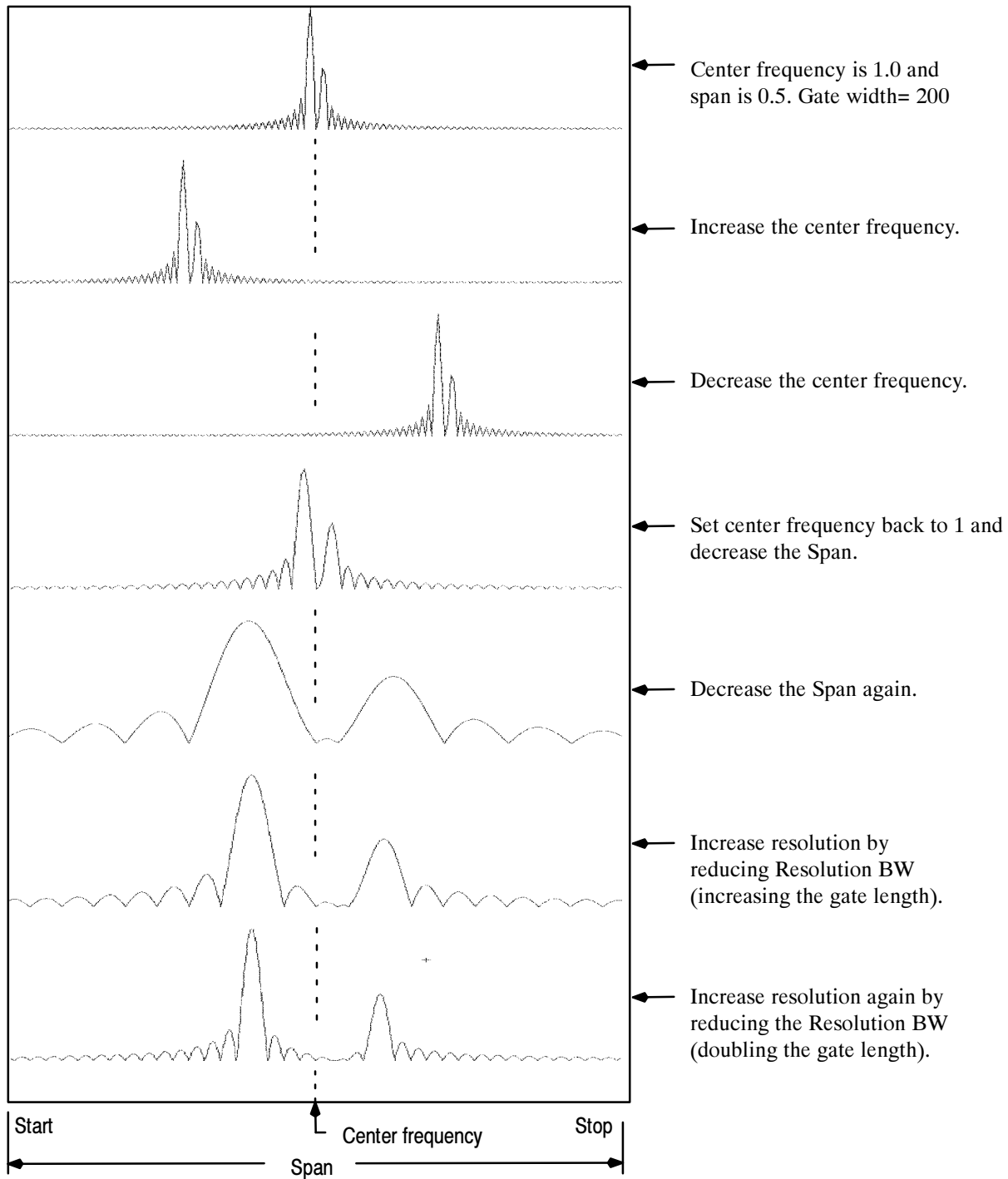

Figure 3-44: Effects of frequency domain control adjustments

Using the magnitude controls. Vertical units can be either linear or log. You may select these choices by clicking the Math menu button. Then select the Spectral Analysis Setup command. On the Mag tab, select the desired scale type from Linear, dB, or dBm.

Linear: When the spectrum is linear magnitude the vertical units are the same as the source waveform. Usually this is volts. However, it may also be watts or amperes.

dB: This sets the vertical scale of the magnitude spectrum to dB. Use the Reference Level Offset to set which vertical position in the magnitude spectrum will be zero dB. The following equation applies:

$$dB = 20 \log\left(\frac{|X|}{Ref}\right)$$

Where X is a complex data point in the spectrum and Ref is the Reference Level Offset value.

dBm: This selects dB as described in the above equation, but also sets the Reference Level Offset to a value that is equivalent to 1 mW of power into 50 Ω . Therefore, if the input units are volts, then the value is set to 223.6 mV. If the input units are amperes, then the value is set to 40 μ A. If the input units are watts, then the value is set to 1 mW.

Reference Level: This sets the vertical position of the displayed spectrum. Its value is the magnitude at the top of the display screen. When this control is adjusted, the spectral waveform along with its zero reference marker move vertically on the screen (see Figure 3-45). This control does not change the spectral data.

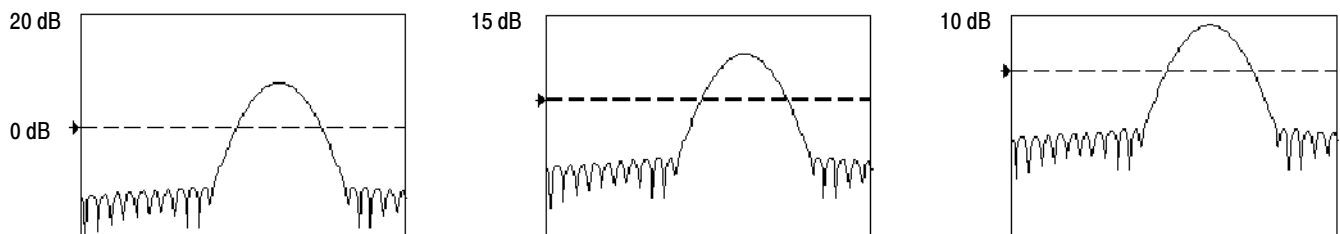

Figure 3-45: Effects of adjusting the reference level

Reference Level Offset: This changes the value of Ref in the equation for dB shown above. Unlike the Reference Level control, this control actually changes the output data values in the spectrum. Zero dB is shown on the display screen by the marker associated with the spectral waveform. Adjusting the Reference Level Offset causes the spectral waveform to move vertically with respect to the

waveform reference marker. This moves the waveform without changing the Reference Level control setting. Sometimes it is beneficial to adjust this control so that the peak of a fundamental is at zero dB. Then you can measure other harmonics in terms of how many dB they are away from the fundamental. Click the dBm button to preset this level to the equivalent of 1 mW into 50 ohms.

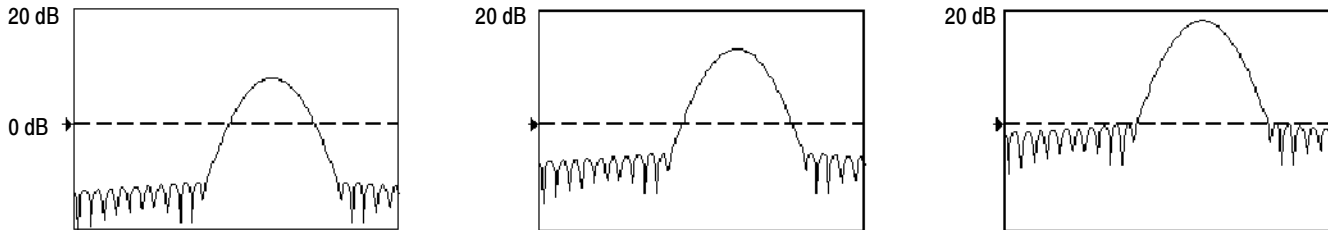

Figure 3-46: Effects of adjusting the reference level offset control

Real and Imaginary Magnitudes: You can display the linear magnitude of the real data or the imaginary data in the spectrum. This is useful if you process the spectrum off line and transform it back into a time domain trace. You can save the real and the imaginary spectrum into reference memory, and export the waveforms directly into Mathcad, MATLAB, or Excel documents to update in real time.

To turn on a real or imaginary spectrum, click the Math menu button, select Define/Edit Expression Editor, and select the Freq tab. Click either the Real or the Imag buttons and enter an expression. Click the appropriate channel button, and click Apply.

Using the Phase Controls. You can set the vertical units to Degrees, Radians, or Group Delay in seconds. To do this, click the Math toolbar button, click Spectral Analysis Setup, and select the Phase tab. Then select the desired scale type from Degrees, Radians, or Group Delay.

Phase Reference Position: Phase is a relative measurement that must have a time domain reference point. The phase value is specified with respect to this phase reference position.

For the spectral analyzer, the phase reference position is the 50% position of the gate, that is, the middle of the gate interval of the data that is input to the spectral analyzer. This is true for all window functions except for the Tek Exponential window. This window has the reference point at the 20% position of the gate.

Phase Unwrap: The spectral analyzer produces phase values from $-\pi$ to π radians or -180 to 180 degrees. However, when you perform impulse response testing and the phase is continuous, then phase values outside these ranges may occur. The spectral analyzer then wraps the data with discontinuities in the

display from +180 to -180 degrees. Phase unwrap will display the correct result by unwrapping the phase.

Phase unwrap is only valid when the phase spectrum is a continuous function of frequency. Therefore, do not use it when analyzing the harmonic content of the typical repetitive signal.

Suppression Threshold: Random noise in the spectrum may have phase values over the entire range. This could make the phase display unusable. However, you can set the suppression threshold control to a level in dB. The phase of any complex spectral points with a magnitude below this threshold is set to zero.

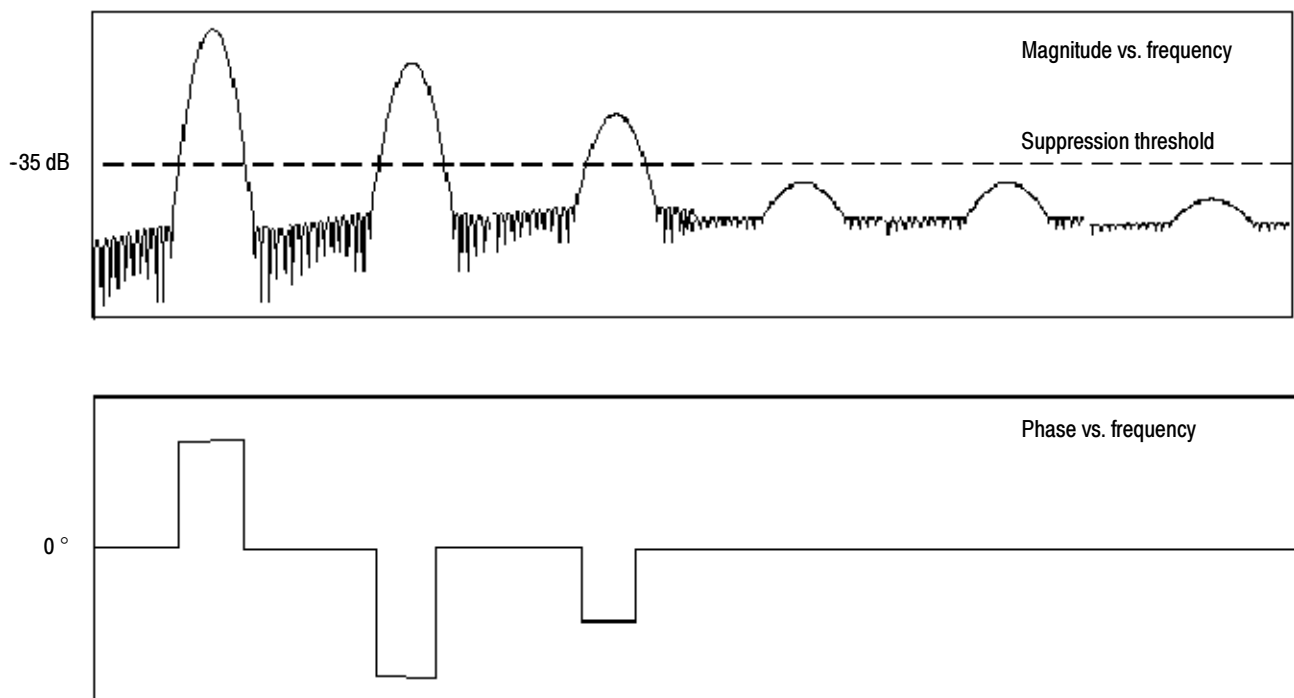

Figure 3-47: Example of the effects of setting the phase suppression threshold

Group Delay: When the phase spectrum is a continuous function of frequency, group delay may be computed. This is true of impulse response testing where an impulse is fed into the system, and the spectrum of the response of the system output is computed.

Group delay measures how well a system passes a signal in terms of phase distortion. Group delay is the derivative of the phase with respect to frequency.

This feature is not useful for analysis of harmonic content of signals where the phase response is not continuous.

Impulse Response Testing: When performing impulse response testing of a system, place the impulse at the zero-phase reference position of the acquisition. This produces a correct phase display. Because the Tek Exponential window has its zero phase reference position at the 20% point, more of the impulse response is captured. All other window functions have their phase reference position at the 50% position in the gated region.

There are several ways to adjust the position of the zero phase reference point with respect to your input signal:

- Adjust the spectral analyzer gate position
- Perform fine adjustment using the front-panel trigger level control
- Adjust the front-panel horizontal POSITION control

Using windows to filter. There are eight different spectral analyzer windows:

- Rectangular
- Hamming
- Hanning
- Kaiser-Bessel
- Gaussian
- Blackman-Harris
- Flattop2
- TekExponential

In the time domain, a window is a bell-shaped function equal in length to the gate duration. For most windows, this function tapers to zero at both ends of the gate region. Before computation of the spectral transformation, the window is multiplied, sample by sample, times the input data in the gated region. The window function affects the shape of the spectral analyzer response in the frequency domain. The window functions affect the ability to resolve frequency in the output spectrum and can affect the accuracy of the magnitude and phase measurements. Figure 3-48 shows how the time domain record is processed.

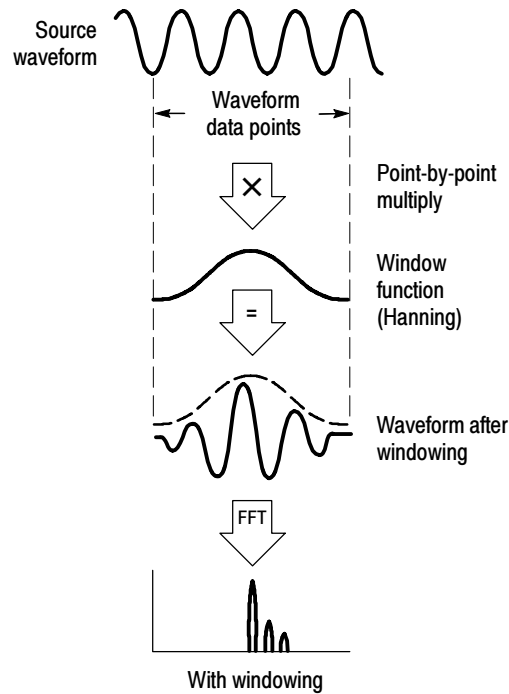

Figure 3-48: Windowing the time domain record

Accurate magnitude measurements require that the input source waveform be stationary within the gated region. This means that waveform parameters such as frequency and amplitude should not change significantly as a function of time within the gate region that is input to the spectral analyzer. Also, the gate width must be greater than or equal to the period of the start frequency of the span of the spectral analyzer. That is, there must be at least one cycle of the harmonic being measured within the gated region.

Choice of a window: Your choice of window function will depend on the input source characteristics that you want to observe and the characteristics of the window function. The window characteristics are shown in Table 3-13.

Table 3-13: Window characteristics

Window	3 dB BW in bins	Scallop loss	Nearest side lobe	Zero phase reference	Coefficients
Rectangular	0.89	3.96 dB	-13 dB	50%	1.0
Hamming	1.3	1.78 dB	-43 dB	50%	0.543478, 0.456522
Hanning	1.44	1.42 dB	-32 dB	50%	0.5, 0.5
Kaiser-Bessel	1.72	1.02 dB	-69 dB	50%	0.40243, 0.49804, 0.09831, 0.00122

Table 3- 13: Window characteristics (Cont.)

Window	3 dB BW in bins	Scallop loss	Nearest side lobe	Zero phase reference	Coefficients
Blackman-Harris	1.92	0.81 dB	-92 dB	50%	0.35875, 0.48829, 0.14128, 0.01168
Gaussian	2.0	0.76 dB	-79 dB	50%	a = 3.75 (not cosine series)
Flatop2	3.8	0.0065 dB	-90 dB	50%	0.213348, -0.206985, 0.139512, -0.043084, 0.003745
Tek Exponential	1.42	0.60 dB	-67 dB	20%	na

3 dB BW in Bins: This is the bandwidth of the filter response of the spectral analyzer to a sine wave input for a given window function. It is given in units of bins. A bin is the interval between spectral samples when the interpolation ratio due to FFT zero fill is one. The bandwidth is measured between the points on the lobe that are 3 dB down from the peak of the lobe. The bandwidth in hertz may be computed by dividing the BW in bins by the gate duration in seconds. This is also referred to as resolution bandwidth (RBW).

Coherent gain: The gain factor normally associated with different window functions is correctly scaled into the magnitude spectrum output. Therefore, the magnitudes in the output spectrum do not change as different windows are selected. (An exception is if the analyzer settings are such that no zero fill is used in the FFT. Under this condition different scallop loss factors of different windows might cause slight variations in magnitudes. Most of the time zero fill is in effect and scallop is not present.)

Scallop Loss: This is the magnitude error of the spectral analyzer when the frequency of the observed signal is exactly half way between two frequency samples of the spectrum when the interpolation ratio due to zero fill of the FFT is one. When zero fill is in effect, scallop loss is essentially eliminated because of the interpolation in the frequency domain due to zero fill. If you work with span settings less than full and you work with larger resolution bandwidth settings, zero fill is in effect most of the time.

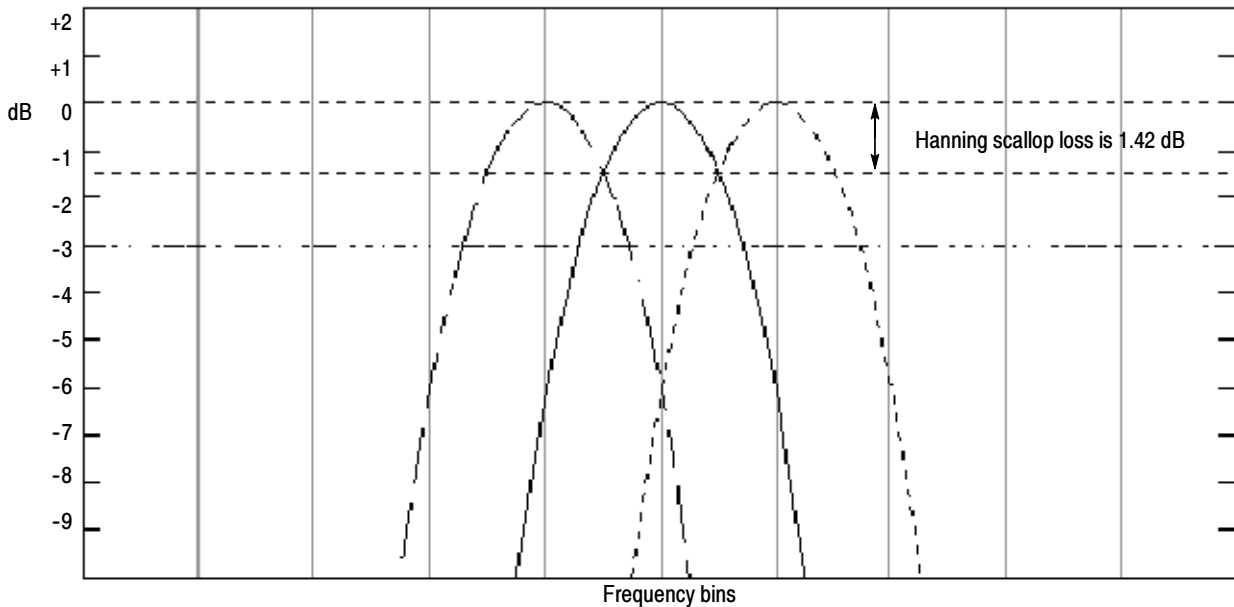

Figure 3-49: Example of scallop loss for a Hanning window without zero fill

Nearest Side Lobe: This is the difference in magnitude between the spectral lobe peak in the spectrum and the next side lobe that occurs due to energy leakage. Different windows have different leakage characteristics. The more narrow the resolution bandwidth of the window the more leakage in the spectrum.

Zero Phase Reference: This is the position in the time domain gate that is the reference point for phase in the output spectrum. That is, if a sine wave input has its peak at the zero phase reference position, then it reads out as zero phase in the spectrum. If the phase is to be correct when doing impulse response testing, the impulse in the time domain must be located at this position in the gate interval.

Coefficients: These are used to generate the windows which are constructed from a cosine series. For the Gaussian window, the value of “a” is given instead of a set of coefficients. You can find descriptions of cosine series windows in the *Handbook of Digital Signal Processing Engineering Applications* by Elliot. ISBN 0-12-237075-9.

Gaussian Window: This is the default window function (see Figure 3-50). It is unique in that the time-domain shape of an exponential Gaussian function transforms into a Gaussian exponential shape in the frequency domain. This window provides optimal localization in both the time and the frequency domain.

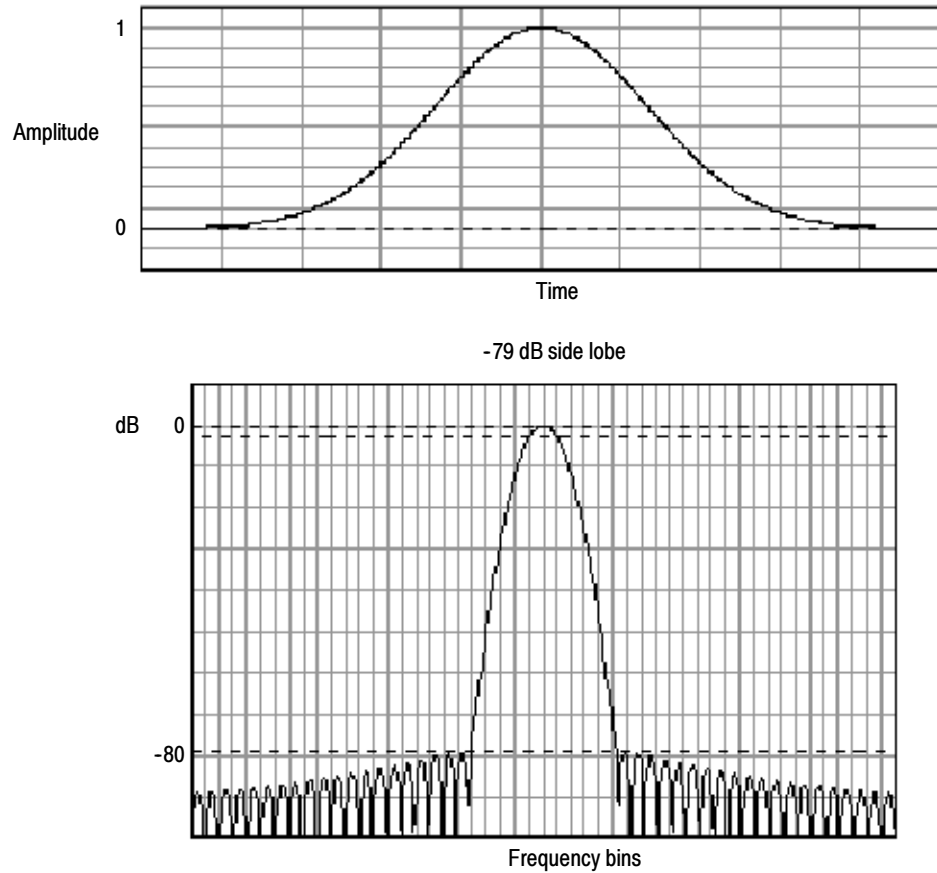

Figure 3-50: Time and frequency graphs for the Gaussian window

Rectangular Window: This window is equal to unity (see Figure 3-51). This means the data samples in the gate are not modified before input to the spectral analyzer. This window has the narrowest resolution bandwidth of any of the windows, but it also has the most spectral leakage and the highest side lobes.

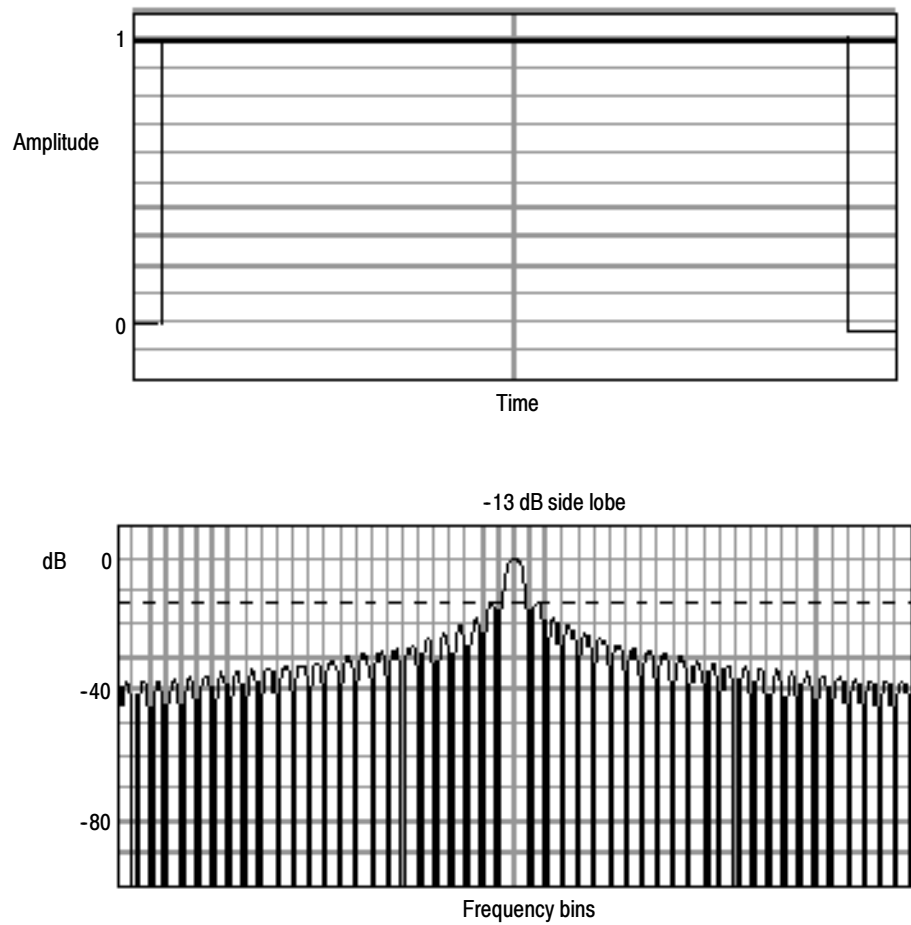

Figure 3-51: Time and frequency domain graphs for the Rectangular window

Hamming Window: This window is unique in that the time domain shape does not taper all the way to zero at the ends. This makes it a good choice if you wanted to process the real and imaginary parts of the spectrum off line and inverse transform it back to the time domain. Because the data does not taper to zero, you could remove the effect of the window function from the result.

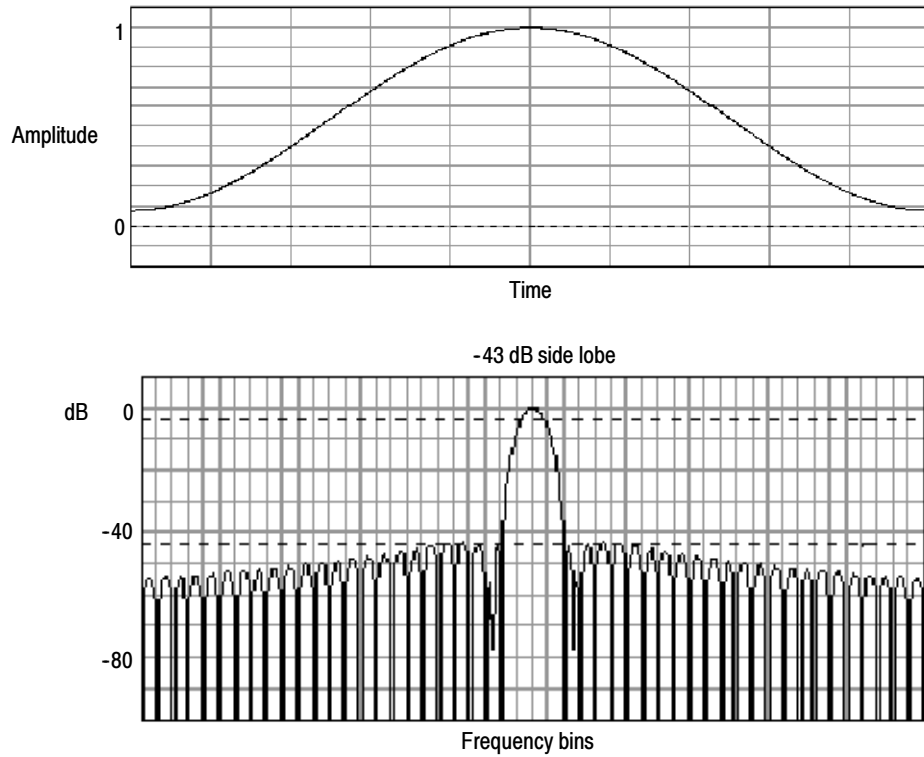

Figure 3-52: Time and frequency graphs of the Hamming window

Hanning, Kaiser-Bessel, and Blackman-Harris Windows: These windows have various resolution bandwidths and scallop losses (see figures 3-53, 3-54, and 3-55). Choose the one that best allows you to view the signal characteristics you are interested in. The Blackman-Harris has a low amount of energy leakage compared to the other windows. The Hanning has the narrowest resolution bandwidth, but higher side lobes.

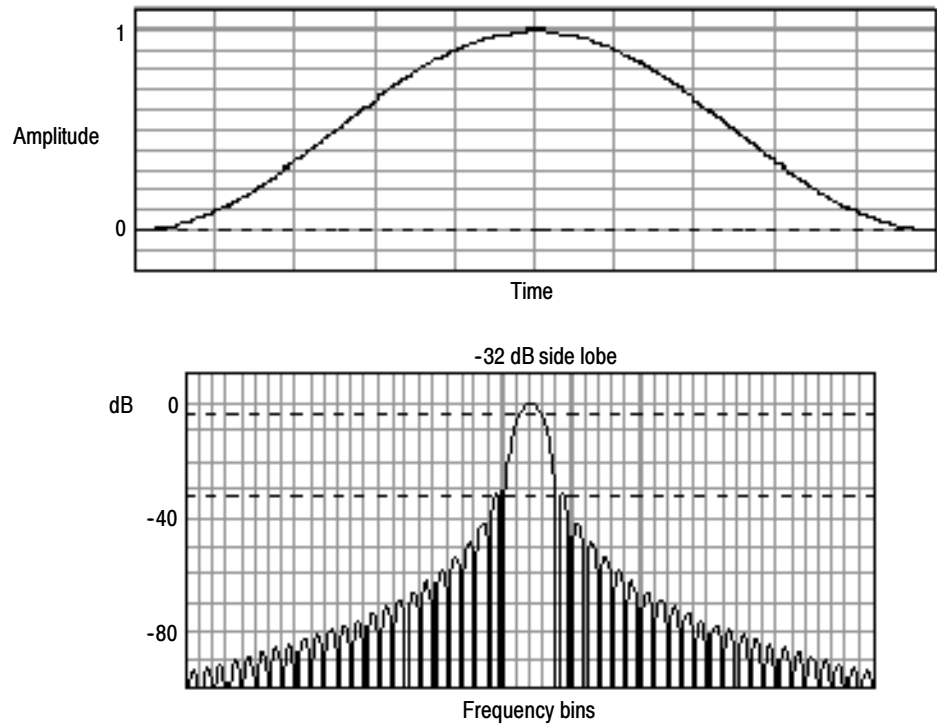

Figure 3-53: Time and frequency graphs for the Hanning window

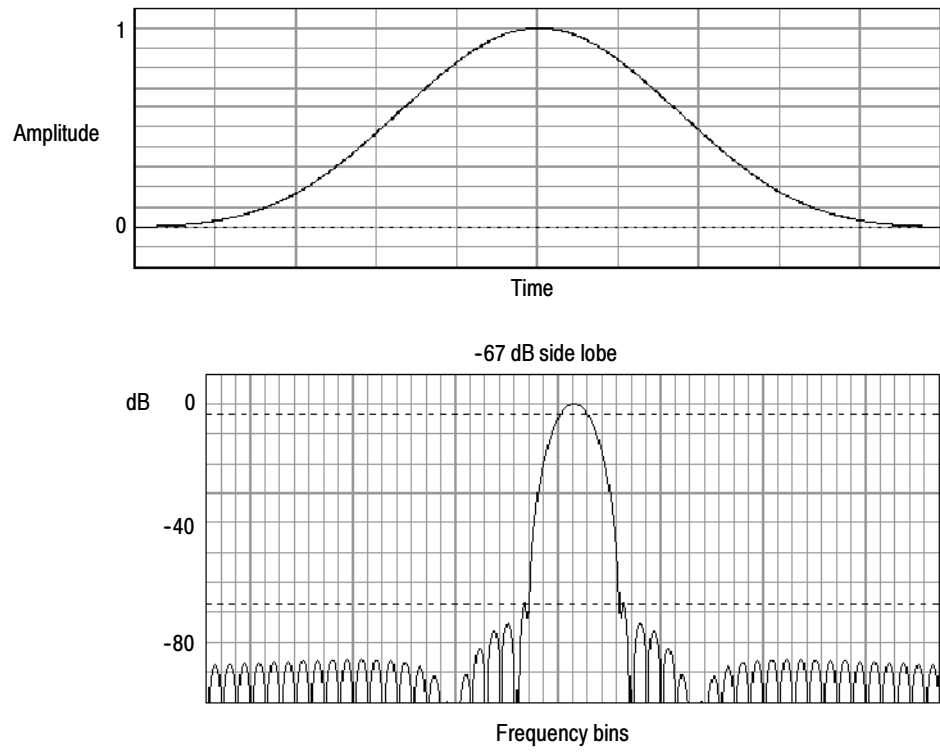

Figure 3-54: Time and frequency graphs for the Kaiser-Bessel window

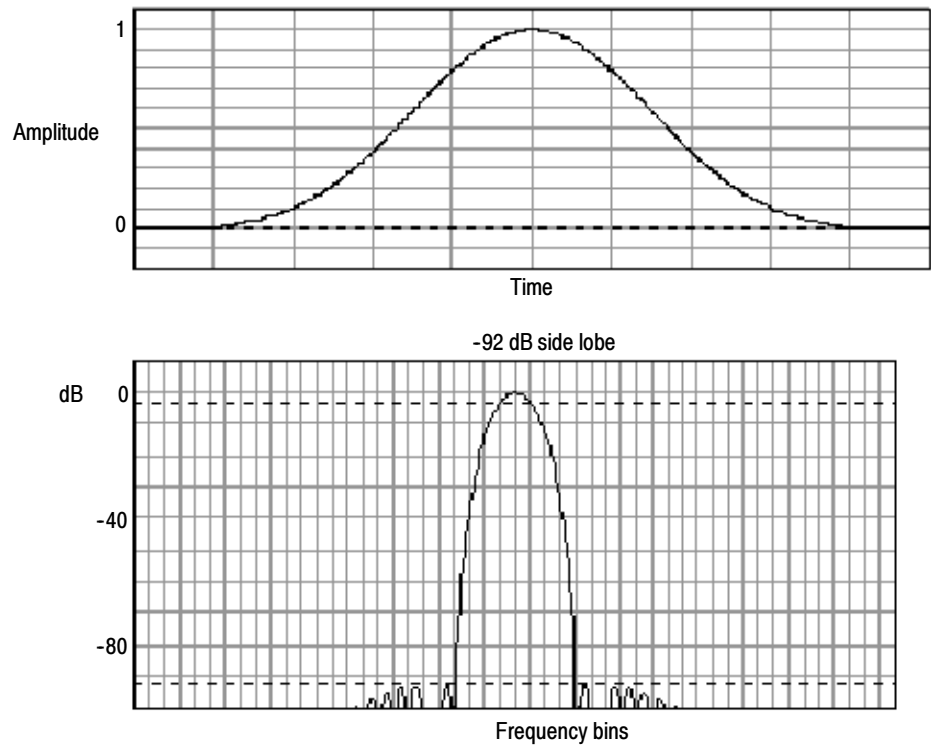

Figure 3-55: Time and frequency graphs of the Blackman-Harris window

Flattop2 Window: This window has the lowest scallop loss of any of the windows. It also has a wider resolution bandwidth but lower side lobe attenuation. Also, it is unique because the time domain shape has negative values.

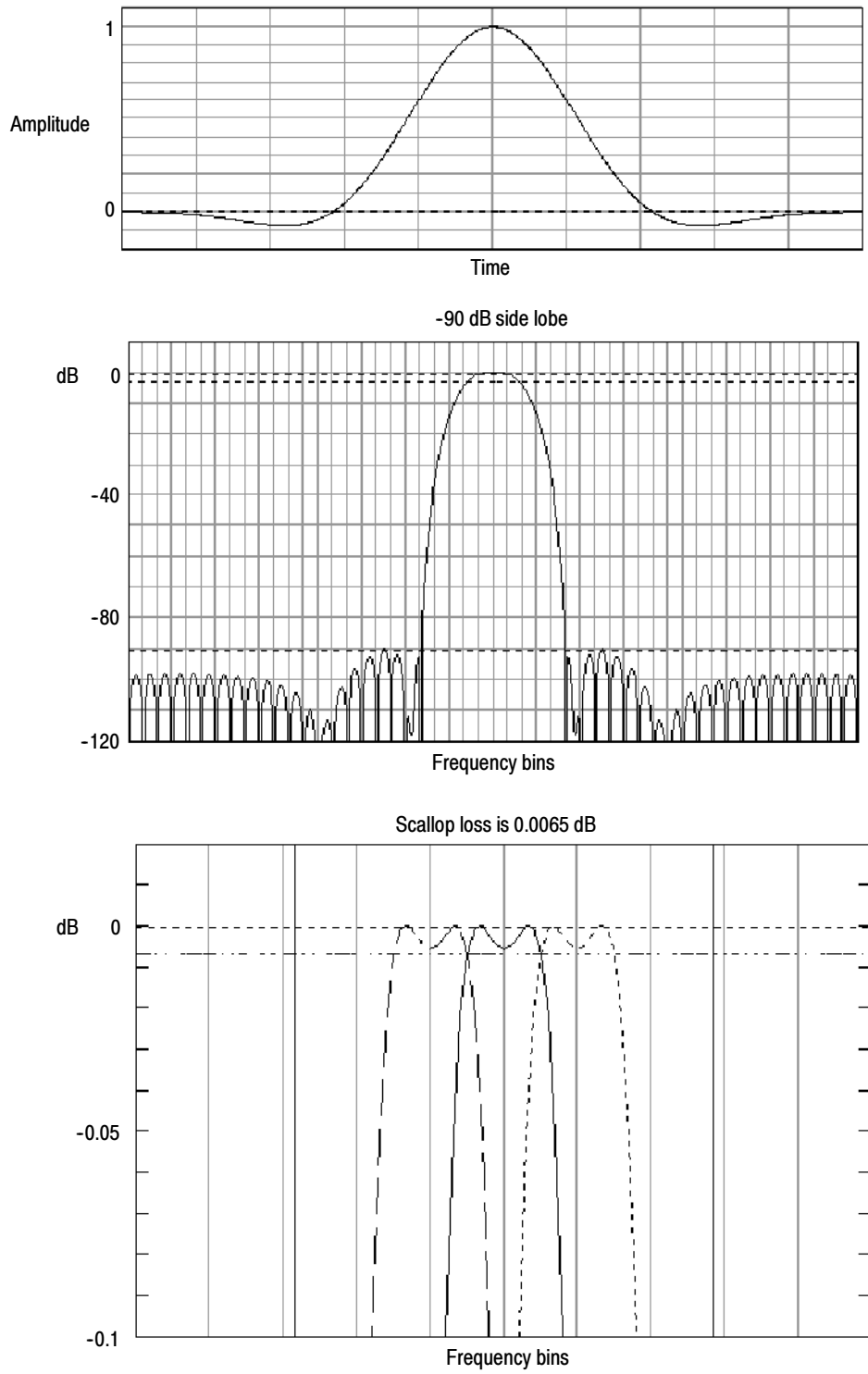

Figure 3-56: Time and frequency domain graphs for the Flattop2 window

Tek Exponential Window: The Tek Exponential window was invented at Tektronix. In the time domain, it is not a symmetrical bell shape as is the case with the other windows. Instead, it is exponential with a peak at the 20% position of the time domain gate. The frequency domain shape is triangular. Use this window for impulse response testing where the 20% position is the zero phase reference point. More of the acquired data record length is used to capture the impulse response. Exact details of how to compute its values were published in the article, *Impulse-response testing lets a single test do the work of thousands* by John Pickerd in EDN magazine, April 27, 1995, page 95.

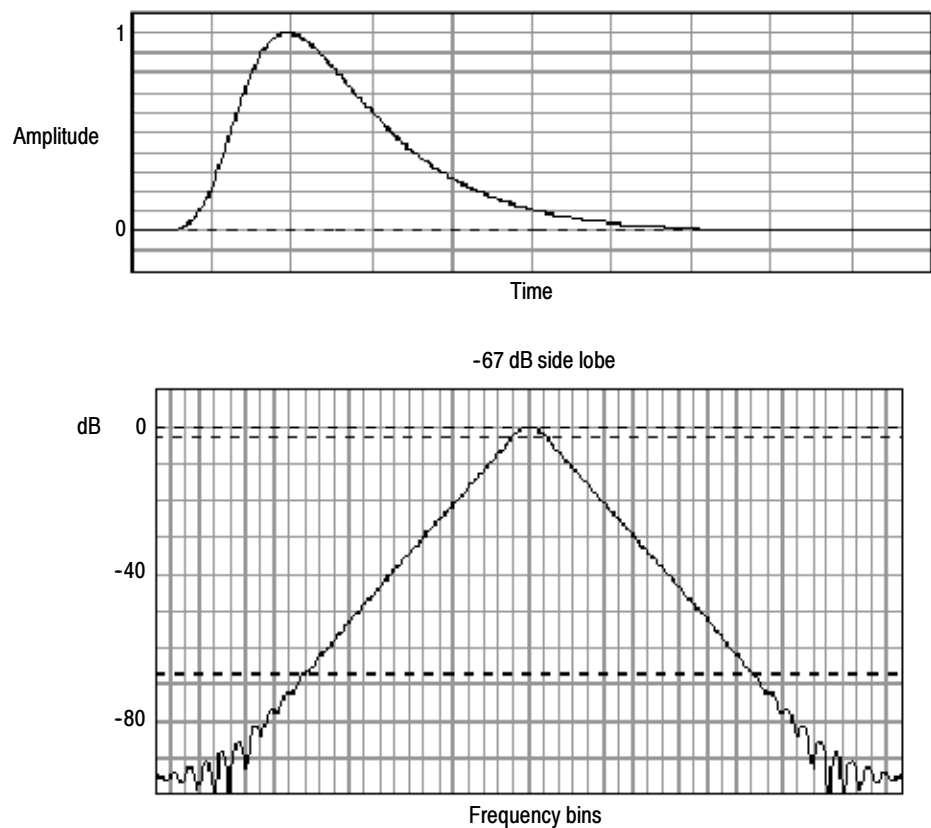

Figure 3-57: Tek Exponential window in the time and the frequency domains

Effects of trigger jitter. The oscilloscope acquisition system has a sample clock that is asynchronous with respect to the input signal. This means that from one acquisition to the next, samples may be in a different position on the waveform with respect to the trigger. Samples may vary in position by up to one sample interval.

There are only two samples per cycle of a signal that have a frequency equal to one half of the sample rate. This is the highest nonaliased signal that can be output from the spectral analyzer. Thus, at this frequency, one sample of acquisition jitter will show up in the spectrum as 180 degree phase variations. Therefore, when you analyze phase, make sure to oversample the signal sufficiently such that the one sample interval of jitter that is showing up in the phase is acceptable to the accuracy you want to achieve.

Effects of Average and High Res acquisition modes: The result of averaging the time domain acquisition using either Average mode or Hi Res acquisition mode affects the frequency response of the oscilloscope. This is due to the one sample of jitter in the acquisition system. Both Hi Res and Average acquisition modes have the same affect on the frequency response. These modes cause the response to roll off from a magnitude value of one at DC to a magnitude value of 0.63 at Nyquist which is the frequency equal to one half of the sample rate. This is true regardless of the real time sample rate setting.

Frequency Domain Averaging: Turn on averaging for a math waveform by editing the math expression. Sometimes, it is more desirable to average in the spectrum than in the time domain. For example, consider a signal that has time domain components that are asynchronous to the trigger. If you turn averaging in the time domain, these components may go to zero or produce strange nondeterministic effects on the resultant waveform. Thus, these signal components may end up not appearing in the spectrum. However, if averaging is done in the frequency domain instead, then these components will be present.

Recognizing Aliasing

Aliasing occurs when the input frequency of a signal is greater than one half of the sampling frequency (the sample rate).

Set the sample rate high enough so that the signals in the spectrum appear at their correct frequency as opposed to a lower aliased frequency value. Also, complex signal shapes that have many harmonics in them, such as a triangle or square wave, can appear to be OK in the time domain when in fact many of the harmonics in that signal are aliased.

One way to check for aliasing is to increase the sample rate and observe whether any of the harmonics unwrap to different frequency locations.

Another way to recognize aliasing is to realize that higher order harmonics usually have decreasing magnitudes compared to lower order harmonics. Thus, if you see a series of increasing harmonic magnitude values as frequency increases then you can suspect that they may be aliased. In the spectral math waveform, the actual higher frequency components are undersampled, and therefore they appear as lower frequency aliases that “fold back” around the Nyquist point. (See Figure 3-58.) You may test by increasing the sample rate and observing if aliases unwrap to different frequency positions.

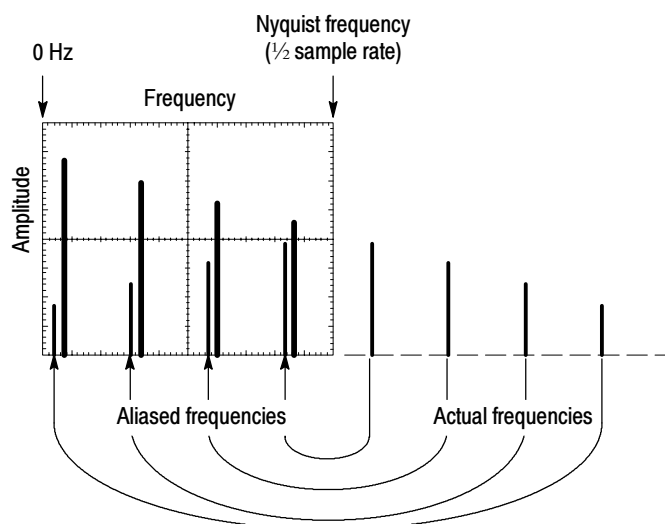

Figure 3-58: How aliased frequencies appear in a spectral waveform



If you have a variable-frequency signal source, another way to observe aliasing is to adjust the frequency slowly while watching the spectral display. If some of the harmonics are aliased, you will see the harmonics decreasing in frequency when they should be increasing or vice versa.

To Take Cursor Measurements of a Spectral Math Waveform. Once you have displayed a spectral math waveform, use cursors to measure its frequency, amplitude, or phase angle. Use the procedure found in *Taking Cursor Measurements* on page 3-124.

To Take Automated Measurements of a Spectral Math Waveform. You can use automated measurements to measure spectral math waveforms. Use the procedure found in *Taking Automatic Measurements* on page 3-115.

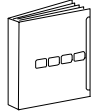

Selecting a Predefined Spectral Math Function (Optional)



Use the procedure that follows to define the current waveform as a spectral magnitude waveform or a spectral phase waveform.

Overview	To select a predefined spectral math function	Control elements and resources
<p>Prerequisites</p>	<p>1. The source that you want to use must be available. Spectral waveforms are created from live waveforms; you cannot create a spectral waveform from math or reference waveforms.</p>	 <p>See page page 3-25 for acquisition setup</p>
<p>Open the Math Setup control window</p>	<p>2. From the toolbar, click Math button to open the Math Setup control window.</p>	
<p>Select a predefined spectral analysis math function</p>	<p>3. Select the Math<i>n</i> tab for the waveform that you want to create and click Predefined Mag or Phase to select magnitude or phase spectral analysis. The waveform display is activated.</p>	

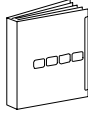
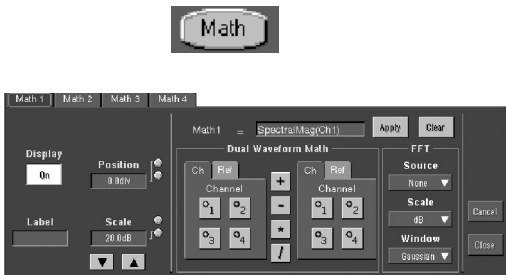
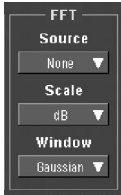
Defining a Spectral Math Waveform

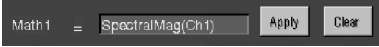

Use this procedure to define a spectral math waveform. If you have purchased the Advanced Analysis option (TDS5UP Option 2A), use the subsequent procedure beginning on page 3-176.



Overview	To define a spectral math waveform	Control elements and resources
<p>Prerequisites</p>	<p>1. All sources that you will use in your math waveform must be available.</p>	 <p>See page page 3-25 for acquisition setup</p>
<p>Open the Math Setup control window</p>	<p>2. From the toolbar, click the Math button to open the Math Setup control window.</p> <p>3. Click the Mathn tab of the math waveform you want to define.</p>	
<p>Select the source and display the spectral waveform</p>	<p>4. Select the source for the spectral waveform from the FFT Source drop-down list. The source can be a live waveform or another math waveform.</p> <p>Notice that the spectral waveform is displayed as soon as you select the source.</p>	
<p>Set the magnitude scale</p>	<p>5. Select a value from the Scale drop-down list to select the vertical scale factor:</p> <ul style="list-style-type: none"> ■ dB displays magnitude using the log scale, expressed in dB relative to the reference level offset. ■ Linear displays magnitude using units equal to the source units. ■ dBm sets the reference level offset to predefined values for dBm. <p>Tip. You can adjust the scale and position by clicking the waveform handle and using the multipurpose knobs.</p>	

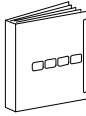

Overview	To define a spectral math waveform	Control elements and resources
<p>Select the window type</p>	<p>6. To select the window type, click Window Type and select from the list. A discussion of the FFT window types begins on page 3-160.</p>	
<p>Redefine the spectral waveform</p>	<p>7. To redefine your waveform, click Clear and repeat the above steps.</p>	
<p>For further assistance</p>	<p>8. Access the online help for more information about creating spectral math waveforms.</p>	 <p>See <i>Accessing Online Help</i> on page 3-209 for an overview of the online help system</p>



Defining a Spectral Math Waveform (Optional)

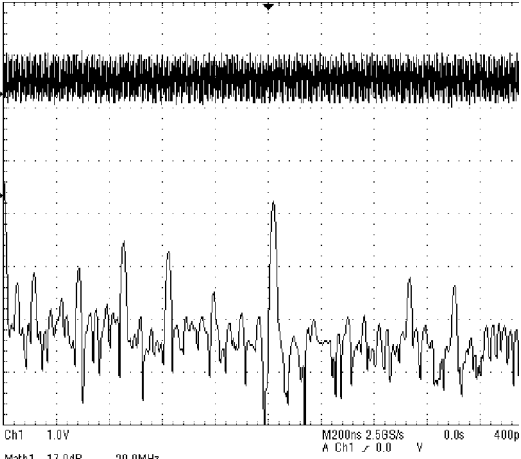

Use this procedure to define a spectral math waveform using the Advanced Analysis option. First ensure that the sources you use exist. Channel sources should be acquiring or have acquired data. These sources do not have to be displayed to be used.



Overview	To define a spectral math waveform	Control elements and resources
<p>Prerequisites</p>	<p>1. All sources that you will use in your math waveform must be available.</p>	 <p>See page page 3-25 for acquisition setup</p>
<p>Open the Spectral Analysis Setup control window</p>	<p>2. From the toolbar, click the Math button to open the Math Setup control window. 3. Click Spectral Analysis Setup to open the Spectral Analysis Setup control window.</p>	

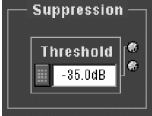
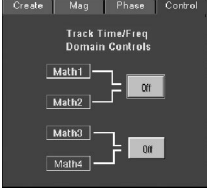

Overview	To define a spectral math waveform	Control elements and resources
<p>Select a spectral waveform</p>	<ol style="list-style-type: none"> Click Mathn and select the math waveform that you want to create from the list. Click Magnitude to create a magnitude spectral waveform or Phase to create a phase spectral waveform. If you want an averaged spectral waveform, click Average, and click Avgs to set the number of averages. See <i>Apply Averaging</i> on page 3-147. Select the tab and channel number for the source waveform. <p>Tip. If you want to redefine your waveform, click Clear button, and repeat the above steps.</p>	 
<p>Display the spectral waveform</p>	<ol style="list-style-type: none"> To display your spectral waveform, click Apply or OK. 	

Overview	To define a spectral math waveform	Control elements and resources
<p>Set the magnitude scale</p>	<p>8. Select the Mag tab.</p> <p>9. To select the vertical scale factor, click Scale:</p> <ul style="list-style-type: none"> ■ dB to display magnitude using the log scale, expressed in dB relative to the reference level offset. ■ Linear to display magnitude using units equal to the source units. ■ dBm to set the reference level offset to predefined values for dBm; see next step. <p>Tip. You can adjust the scale and position by clicking the waveform handle and using the multipurpose knobs.</p> <p>10. To set the reference level, click Reference Level and use the multipurpose knobs or pop-up keypad to set the reference level.</p> <p>Tip. Reference level is the value at the top of the display screen. It only applies to magnitude waveforms. Adjusting the reference level positions the waveform with respect to the top of the display, but does not change the position of the waveform with respect to its ground reference.</p> <p>11. To set the reference level offset, click Reference Level Offset, and use the multipurpose knobs or pop-up keypad to set the offset.</p> <p>Tip. Offset determines where zero dB is in the output waveform. Changing offset moves the waveform with respect to its ground reference. When the input is equal to the offset, it will display as zero dB in the output.</p>	 <p>The screenshot shows the 'Mag' control panel with tabs for 'Create', 'Mag', 'Phase', and 'Control'. Under the 'Scale' section, there are three buttons: 'Linear', 'dBm', and 'dB'. Under the 'Reference' section, there are two fields: 'Level' set to '20.0dB' and 'Level Offset' set to '223.6mV'.</p>  <p>This close-up shows the 'Reference' control panel with a 'Level' field set to '20.0dB' and a 'Level Offset' field set to '223.6mV'. Each field has a small keypad icon to its right.</p>  <p>This close-up shows the 'Reference' control panel with a 'Level' field set to '20.0dB' and a 'Level Offset' field set to '223.6mV'. Each field has a small keypad icon to its right.</p>

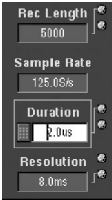
Overview	To define a spectral math waveform	Control elements and resources
<p>Set the phase scale</p>	<p>12. Select the Phase tab.</p> <p>13. To select the vertical scale factor click Scale:</p> <ul style="list-style-type: none"> ■ Degree to set the phase units to degrees. Phase is displayed using degrees as the scale, where degrees wrap from -180° to $+180^\circ$. ■ Radian to set the phase units to radians. Phase is displayed using radians as the scale, where radians wrap from $-\pi$ to $+\pi$. ■ GroupDelay to unwrap the phase spectrum and display its derivative. <p>The topic <i>Using the Phase Controls</i> on page 3-158 provides in-depth information on setup for phase displays.</p> <p>14. To specify whether to unwrap phase in a spectral analysis phase waveform, click Unwrap to toggle.</p> <p>15. To set the level in dB that a magnitude in the spectrum must exceed to have its phase computed (to reduce the effect of noise in your phase waveform), click Suppression Threshold, and use the multipurpose knobs or pop-up keypad to set the threshold level. If the magnitude is less than the threshold, then its phase is set to zero (for an example, see Figure 3-47 on page 3-159).</p> <p>The topic <i>Suppression Threshold</i>, on page 3-159 provides additional information on phase suppression.</p>	   
<p>Set time and frequency domain control tracking</p>	<p>16. Select the Control tab.</p> <p>17. To enable changing time and frequency domain controls for one math waveform to change the same controls for another math waveform, click the Track Time/Freq Domain Controls buttons to toggle them on or off.</p>	

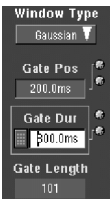
Overview	To define a spectral math waveform	Control elements and resources
<p>Select the window type</p>	<p>18. To select the window type,click Window Type and select from the list. A discussion of the FFT window types begins on page 3-160.</p>	
<p>Set the frequency domain controls</p>	<p>19. To set the frequency range over which the spectral analysis is performed, click Freq Span and use the multipurpose knobs or pop-up keypad to set the frequency range.</p> <p>Higher sample rates allow you to set greater frequency spans. To set the frequency span to the maximum allowed by the current sample rate, click Full.</p> <p>20. To set the center frequency of the spectral analysis, click Center Freq and use the multipurpose knobs or pop-up keypad to set the center frequency.</p> <p>21. Resolution bandwidth determines how small of a frequency difference can be resolved in the frequency domain output data. It basically defines the bandwidth of the filters used to do the frequency domain analysis.</p> <p>To set the resolution bandwidth, touch Res BW, and use the multipurpose knobs or keypad to set the resolution bandwidth.</p>	

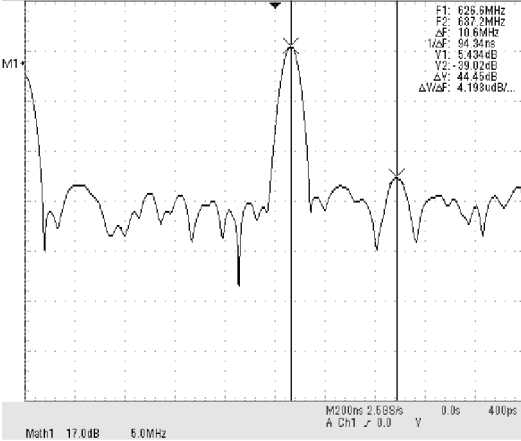
Overview	To define a spectral math waveform	Control elements and resources
<p>Set the time domain controls</p>	<p>22. The Time domain controls determine the sample rate and record length of the acquisition. These controls allow you to change the duration on the acquisition without changing the sample rate.</p> <p>From the Spectral Analysis Setup menu, click Resolution and adjust the time interval between data samples of the input waveform.</p> <p>Note: Resolution is the inverse of Sample rate. Adjust resolution to adjust sample rate. Resolution may also cause a change in record length such that the duration is kept constant at the value selected by the Duration control.</p> <p>23. To adjust the number of seconds over the duration of the acquired waveform (record length), click Duration and use the multipurpose knobs or pop-up keypad to adjust the duration.</p> <p>Note: Changing duration also changes the record length.</p> <p>24. Gate position is the position of the phase reference point in the gate with respect to the trigger in seconds. The gate position and gate duration must be within the acquisition.</p> <p>To set the gate position, click Gate Pos, and use the multipurpose knobs or pop-up keypad to adjust the gate position.</p> <p>25. Gate duration and resolution bandwidth are the same. Gate duration is displayed in seconds and resolution bandwidth in hertz.</p> <p>To set the gate duration, click Gate Dur, and use the multipurpose knobs or pop-up keypad to adjust the gate duration.</p>	   

Overview	To define a spectral math waveform	Control elements and resources
<p>Take cursor measurements</p>	<p>26. From the toolbar, click the Cursors button to display the cursors and open the Cursor control window.</p> <p>27. Select the Math tab and click the channel button for the spectral waveform that you want to measure.</p> <p>28. Select the cursor type. For more information, see <i>Taking Cursor Measurements</i> starting on page 3-124).</p> <p>29. Use the multipurpose knobs to position each cursor on the waveform to measure the feature(s) that interests you.</p> <p>30. Read the results in the cursor readout. The cursor readout is displayed under the multipurpose readouts as shown here or in the upper right corner of the graticule area.</p> <p>The figure shows the cursor measurement of a frequency magnitude on an FFT. The readout reads 0 dB because it is aligned with the 1 V_{RMS} level. The other readout reads 24.4 dB indicating the magnitude of the frequency it is measuring is -24.4 dB relative to 1 V_{RMS}. Display of the source waveform is turned off.</p> <p>The cursor units will be in dB or volts for magnitude waveforms and in degrees or radians for those measuring phase.</p> <p>31. Select V Bars and use the multipurpose knobs to align the two vertical cursors to points of interest along the horizontal axis of the waveform.</p> <p>32. Read the frequency difference between the cursors from the Δ: readout. Read the frequency of each cursor relative to the zero frequency point from the cursors readout.</p>	 
<p>For further assistance</p>	<p>33. Access the online help for more information about creating spectral math waveforms.</p>	 <p>See <i>Accessing Online Help</i> on page 3-209 for an overview of the online help system</p>

Data Input/Output

This section describes the input and output capabilities of your oscilloscope:

- *Saving and Recalling Setups* on page 3-183
- *Saving and Recalling Waveforms* on page 3-189
- *Exporting and Copying Waveform Data* on page 3-196
- *Printing Waveforms* on page 3-205
- *Remote Communication* on page 3-207

Saving and Recalling Setups

This oscilloscope can save a number of different instrument setups for later recall, limited only by the space that you have to store the setups.

By saving and recalling different setups, you can switch from setup to setup without having to first manually record your settings and then manually set them. This capability is helpful when you want to:

- Save and recall a setup that optimizes the oscilloscope for displaying and analyzing a certain signal.
- Save a series of setups to help automate a procedure through recall of a sequence of saved setups as part of performing the procedure.
- Export a setup for sharing with a second oscilloscope.

You can include and view comments with your setups when you use the Save Instrument Setups and the Recall Instrument Setups control windows. These comments may describe, for example, each setup you save and its intended application.

If you do not have an attached keyboard, you can still enter comments and name setup files. The Save and Recall windows include a pop-up keyboard that you can use with your mouse or the touch screen to enter the setup path name, file name, and comments.

The oscilloscope excludes the following items when saving setups:

- *Channel waveforms and reference waveforms.* Control settings (scale, position, and so on) are saved but not the waveform data. Upon recall of the setup, the settings are applied, but the data is not restored.

- *Math waveforms.* Control settings and the math expression are retained but not the waveform data. Upon setup recall, however, the math waveform expressions are applied, but math waveform data is not restored.
- *User options stored in the Windows registry.* These include all options set in the User Preferences control window.

If you want to save a waveform in a useful format for other applications, such as a spreadsheet, use the export function (see *Exporting and Copying Waveform Data* on page 3-196).

A few other things to remember when saving and recalling setups:

- Recalling a setup replaces the current setup with the recalled setup. If you do not want to lose your current setup, save the setup file for later recall.
- Saved setups may contain settings inappropriate for waveforms currently in your oscilloscope. For example, if you save a setup that displays a math waveform that is the average of reference waveform 1, when you recall the setup, if the reference is empty, the math and reference waveforms are not displayed.

Using Auto-Increment File Name

The Save As... dialog boxes and Export dialog boxes on this instrument have an Auto-increment file name feature that enables you to save numerous similar files without retyping the entire file name each time. Use this feature by selecting Auto-increment file name on the dialog box as shown in Figure 3-59.

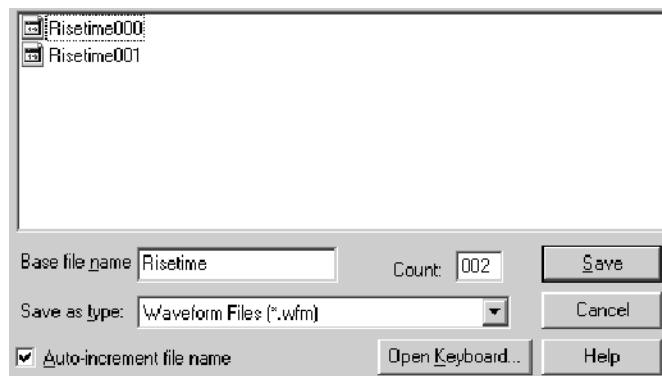

Figure 3-59: Auto-increment file name feature

Enter a Base file name and click Save. For the initial save the default count is 000, but you can overwrite this number if you choose. Your first file is saved as [Basefilename][count].ext, where ext is the file extension. On subsequent saves, the oscilloscope searches for the highest numbered file name and increases the number by one, as in Basefilename001.ext.





For example, if you are saving a series of rise time data files, you can use “Risetime” as the base file name. Your first file is saved as Risetime000.*ext*. The next file will be Risetime001.*ext*, and so on.

If Count reaches 999, it is suggested that you change the base file name to Basefilename1 (for example, Risetime1) on the next save. Your next file will then be saved as Risetime1000.*ext*. You will receive a warning message if you are going to overwrite any files with the same name.

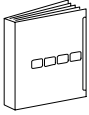
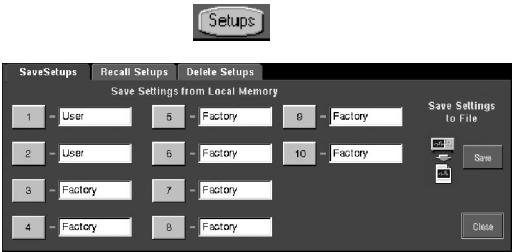
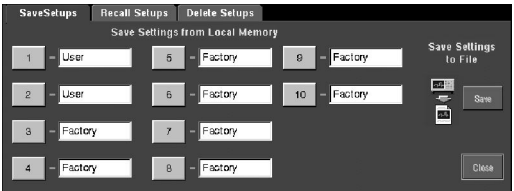

Saving A Setup

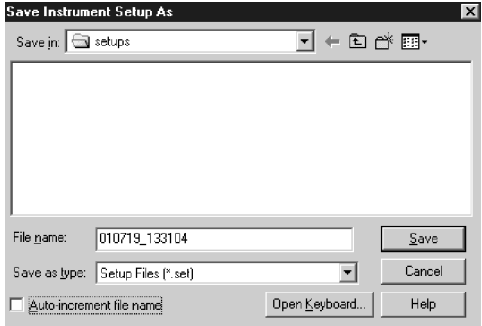

Use the procedure that follows to save a setup to one of ten internal locations, the oscilloscope hard disk, a floppy disk, or third-party storage device.

Overview	To save a setup	Control elements and resources
Prerequisites	<ol style="list-style-type: none"> 1. Power on the oscilloscope. 2. Set up the oscilloscope controls as you want them saved as part of a recallable setup. For help in making your setup, check the references at right and other sections in this chapter specific to the setup you wish to make. 	 <p>See <i>Powering On the Oscilloscope</i> on page 1-8, page 3-25 for acquisition setup, and page 3-49 for trigger setup.</p>
Open the Instrument Setup control window	<ol style="list-style-type: none"> 3. From the toolbar, click Setups to open the Instrument Setup control window. The window opens on the Save Setups tab. 	
Save the setup	<ol style="list-style-type: none"> 4. Click one of the numbered buttons to save the setup. If any data exists in the setup, it will be overwritten. 	

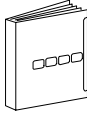
Overview	To save a setup	Control elements and resources
<p>Name the setup</p>	<p>5. Name your setup file by either:</p> <ul style="list-style-type: none"> ■ Accepting the default name (User) that appears in the name field. ■ Double-clicking in the name field and using the pop-up keyboard to enter a new name default file name. ■ Clicking on the existing name and using an attached keyboard to enter a new name. 	
<p>Save the setup to a file</p>	<p>6. Click Save to open the Save Instrument Setup As dialog box.</p> <p>7. Use the Save in: drop-down list to navigate to the directory in which to save your setup.</p> <p>8. Name your setup file. You can accept the default file name that appears in the File name: field, type a new name, or select an existing name from the file list (data in the existing file will be overwritten).</p> <p>Select the Auto-increment file name check box to save a series of files without typing in a new name each time. For more information, see <i>Using Auto-Increment File name</i> on page 3-184.</p> <p>Tip. If you do not have an attached keyboard, click Open Keyboard to display a virtual keyboard.</p> <p>Tip. The file extension specified in the Save as Type list will automatically be appended to the file name. The oscilloscope does not use any user-defined file extensions.</p> <p>9. Click Save to save the setup file. To cancel without saving, click Cancel.</p>	  
<p>For further assistance</p>	<p>10. For more help on saving setups, access the online help.</p>	 <p>See page 3-209 to learn about using online help.</p>

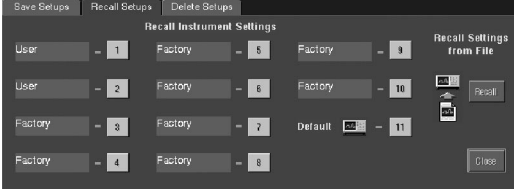
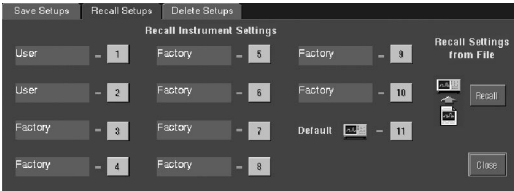
Recalling a Setup Use this procedure to recall a setup. Remember that recalling a setup replaces the existing setup, which is lost.

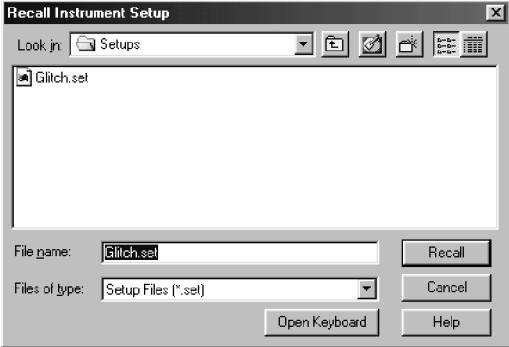
Overview	To recall a setup	Control elements and resources
Prerequisites	1. The oscilloscope must be powered on, and you must have access to a previously saved setup.	 <p>See <i>Powering On the Oscilloscope</i> on page 1-8, and <i>Saving a Setup</i> on page 3-185</p>
Display the Instrument Setup control window	2. From the toolbar, click Setups and select the Recall Setups tab of the Instrument Setup control window.	 
Recall the setup	3. Click the number of the setup that you want to recall. The current oscilloscope setup is overwritten.	

Overview	To recall a setup	Control elements and resources
<p>Recall the setup from a file</p>	<ol style="list-style-type: none"> 4. To open the Recall Instrument Setup dialog box, click Recall. 5. Use the Look in: drop down list and buttons to navigate to the directory which contains a setup that you want to recall. 6. Select your setup file by either clicking an existing name in the file list, or clicking in the File name field and typing a new name. <p>Tip. If you do not have an attached keyboard, click on Open Keyboard to display a virtual keyboard.</p> 7. Click the Recall button to recall the setup file. To cancel without recalling a setup, click Cancel. 	  
<p>For further assistance</p>	<ol style="list-style-type: none"> 8. For more help on recalling setups, access the online help. 	 <p>See page 3-209 to learn about using online help.</p>

Saving and Recalling Waveforms

This oscilloscope can save any number of waveforms, limited only by the space that you have to store them.

By saving a waveform, you can recall it at a later time for comparison, evaluation, and documentation. This is helpful when you want to:

- Recall a waveform for further evaluation or comparison with other waveforms.
- Extend the waveform carrying capacity of the oscilloscope. The oscilloscope supports four reference, four channel, and four math waveforms. If you want more than four reference waveforms, you can save additional references to disk for recall later.



The Reference Setup control window contains a Label field for including comments with your saved waveforms.



If you do not have an attached keyboard, you can still enter comments and name reference waveform files. The Reference Setup control window includes a pop-up keyboard that you can use with your mouse or the touch screen to enter the waveform path name, file name, and comments.

The oscilloscope recalls each waveform into one of the reference waveform locations (Ref1-Ref4). You cannot recall *into* a channel or a math waveform.

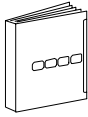
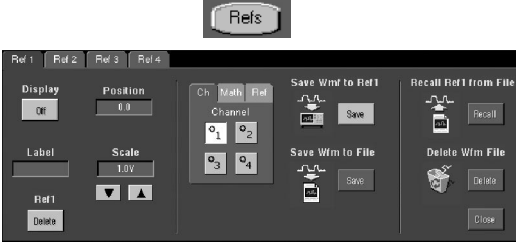
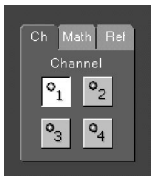
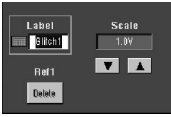
Saving a Waveform

Use this procedure to save a waveform or waveforms to a reference location, the oscilloscope hard disk, a floppy disk, or third-party storage device.

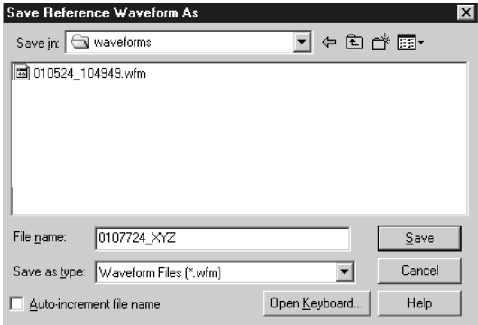
Overview	To save a waveform	Control elements and resources
<p>Prerequisites</p>	<ol style="list-style-type: none"> The oscilloscope must be powered up. Make sure the waveform to be saved exists. Your source must be a channel, an active math waveform, or an active reference waveform. Display the waveform with the setup in which you want to save it. <p>For help in acquiring waveforms, check the references at right.</p>	 <ul style="list-style-type: none"> See <i>Powering On the Oscilloscope</i> on page 1-8. See page 3-25 for acquisition setup. See page 3-49 for trigger setup.
<p>Open the Reference Setup control window</p>	<ol style="list-style-type: none"> From the toolbar, click Refs and select the tab for the reference in which you want to save the waveform. 	
<p>Select the waveform to save</p>	<ol style="list-style-type: none"> Select the Ch, Math, or Ref tab of the waveform that you want to save, and click the appropriate channel number. 	
<p>Label the waveform</p>	<ol style="list-style-type: none"> If you want to label the waveform, click Label and use your keyboard or the pop-up keyboard to create a label for your waveform. 	
<p>Save the waveform to a reference</p>	<ol style="list-style-type: none"> Click Save Wmf to Refx Save to save your waveform. Data in the existing reference will be overwritten. 	





Overview	To save a waveform	Control elements and resources
<p>Save the waveform to a file</p>	<p>7. To save the waveform to a file, click Save Wfm to File Save.</p> <p>8. Use the Save in: drop-down list and buttons to navigate to the directory in which to save your waveform.</p> <p>9. Name your waveform file. You can accept the default file name that appears in the File name: field, type a new name, or select an existing name from the file list (data in the existing file will be overwritten).</p> <p>Select the Auto-increment file name check box to save a series of files without typing in a new name each time. For more information, see <i>Using Auto-Increment File Name</i> on page 3-184.</p> <p>Tip. If you do not have an attached keyboard, click on Open Keyboard to display a virtual keyboard.</p> <p>10. The file extension specified in the Save as Type list will automatically be appended to the file name. You can select from these file formats:</p> <ul style="list-style-type: none"> ■ wfm is an internal oscilloscope format ■ csv is usable by spreadsheets such as Microsoft Excel. ■ dat is usable by Mathcad and MATLAB. ■ txt is the standard text file format. <p>11. Click Save to save the waveform file. To cancel without saving, click Cancel.</p>	  
<p>For further assistance</p>	<p>12. For more help on saving waveforms, access the online help.</p>	 <p>See page 3-209 to learn about using online help.</p>

Recalling A Waveform

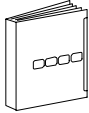
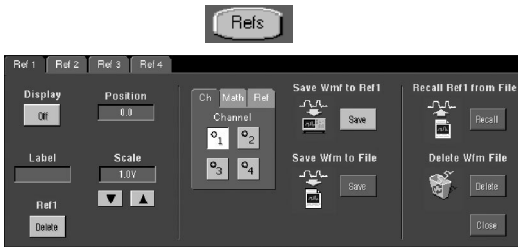
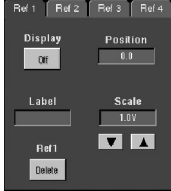
Use the procedure that follows to recall a waveform to a reference. You can only recall waveforms into references.

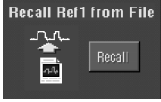
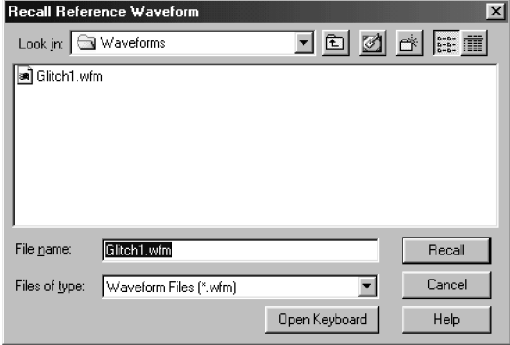
NOTE. Reference waveforms cannot be recalled because they are already resident on the oscilloscope. However, you can copy a reference waveform to another reference: first display the reference to be copied, and then use the Saving a Waveform procedure (page 3-190) to save it to another reference (Ref1-Ref4).

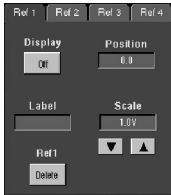

Overview	To recall a waveform	Control elements and resources
<p>Prerequisites</p>	<p>1. The oscilloscope must be powered up. You must have access to a waveform saved by the oscilloscope.</p>	 <p>See <i>Powering On the Oscilloscope</i> on page 1-8, and <i>Saving a Waveform</i> on page 3-190</p>
<p>Display the Reference Setup control window</p>	<p>2. From the toolbar, click Refs and select the tab of the reference into which you want to recall the waveform.</p>	
<p>Recall the waveform</p>	<p>3. If recalling an internal reference, click Display to toggle the display of the reference waveform on.</p>	

Overview	To recall a waveform	Control elements and resources
<p>Recall a reference waveform from a file</p>	<p>4. Click Recall Refx from File Recall to open the Recall Reference Waveform dialog box.</p> <p>5. Use the Look in: drop-down list and buttons to navigate to the directory which contains the waveform that you want to recall. Select your waveform file by either clicking an existing name in the file list, or clicking in the File name field and typing a new name.</p> <p>Tip. If you do not have an attached keyboard, click on Open Keyboard to display a virtual keyboard.</p> <p>Click the Recall button to recall the waveform. To cancel without recalling a waveform, click Cancel.</p>	  
<p>Display the reference waveform</p>	<p>6. Click Display to toggle the display of the reference waveform on.</p>	
<p>For further assistance</p>	<p>7. For more help on recalling waveforms, access the online help.</p>	 <p>See page 3-209 to learn about using online help.</p>

Clearing References

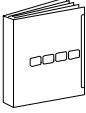
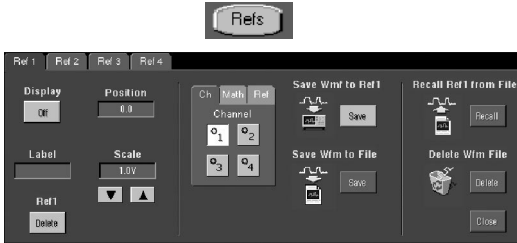
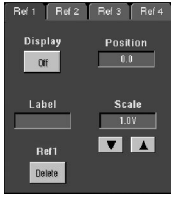
You can clear individual references or delete waveform files. Use this procedure when you are certain that you no longer need the data in these files. To clear all references and setups, use the Utilities menu Tek Secure Erase command.

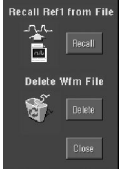
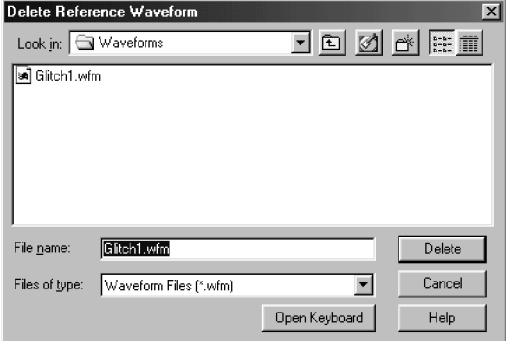
Overview	To clear references	Control elements and resources
<p>Prerequisites</p>	<p>1. The oscilloscope must be powered on. You must have access to a waveform saved by the oscilloscope.</p>	 <p>See <i>Powering On the Oscilloscope</i> on page 1-8, and <i>Saving a Waveform</i> on page 3-190</p>
<p>Display the Reference Setup control window</p>	<p>2. From the toolbar, click Refs and select the tab of the reference you want to delete.</p>	
<p>Delete the reference</p>	<p>3. Click Delete to delete the reference waveform.</p>	

Overview	To clear references	Control elements and resources
<p>Delete a reference waveform file</p>	<p>4. To open the Delete Reference Waveform dialog box, click Delete Wfm File Delete.</p> <p>The Delete Reference Waveform dialog box allows navigation to directories, lists waveform files in the directory, and provides for selection of a waveform file.</p> <p>5. Use the Look in: drop-down list and buttons to navigate to the directory which contains the waveform that you want to delete.</p> <p>6. Select your waveform file by either clicking an existing name in the file list, or clicking in the File name field and typing a new name.</p> <p>Tip. If you do not have an attached keyboard, click on Open Keyboard to display a virtual keyboard.</p> <p>7. Click the Recall button to recall the waveform. To cancel without recalling a waveform, click Cancel.</p>	  
<p>For further assistance</p>	<p>8. For more help on deleting files, touch the Help button to access contextual online help.</p>	 <p>See page 3-209 to learn about using online help.</p>

Exporting and Copying Waveform Data

This oscilloscope also supports exporting waveform data to a file. The oscilloscope can export waveforms, images, and measurements in several formats. You can also copy waveform data to the Windows clipboard for use with other applications, such as spreadsheets or math analysis applications.

A few things to remember when exporting waveform data:

- Waveforms export as a series of comma-separated values (CSV), which are amplitudes without units. There is no timing information, but data is placed in the file in sequence from the first sample in the waveform record to the last.
- Because the waveforms are exported as CSV, without timing and scaling information, the oscilloscope does not import these waveforms directly. If you intend to recall a waveform later, save it (see the procedure *Saving A Waveform* on page 3-190) instead of exporting it.
- You may also choose to copy a waveform and paste it directly into an application such as Microsoft Word or Excel. If so, select your waveform, and then select Copy in the Edit menu.

File Formats. To make exported files more useful, select a file format usable by your analysis tools:

Numeric creates files (.txt) in a numeric format usable by text and word processors.

Text creates files (.txt) in a text format usable by text and word processors.

Bitmap creates files (.bmp) in a bitmap file format usable by many graphic programs.

JPEG creates files (.jpg) in a compressed image format usable by many graphic programs.

Spreadsheet creates files (.CSV) in a format usable by spreadsheets (Excel, Lotus 1-2-3, and Quattro Pro).

MATLAB creates files (.DAT) in a format usable by MATLAB.

Mathcad creates files (.DAT) in a format usable by MathCad.

Note that the MathCad file is an ASCII file, the first four values of which contain header information:



- The first header value holds the record length.
- The second header value holds time, in seconds, between samples.

- The third header value holds the trigger position (expressed as an index in the data position).
- The fourth header value refers to the fractional trigger position.

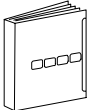
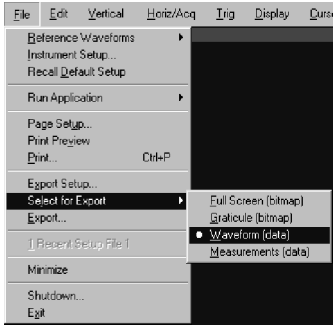

Also note that the delimiters are carriage returns.

Exporting Waveform Data

Use this procedure to export waveforms, images, or measurements to the oscilloscope hard disk, a floppy disk, or third party storage device.

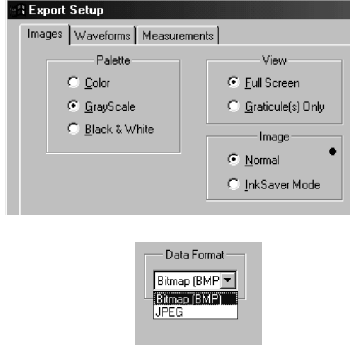
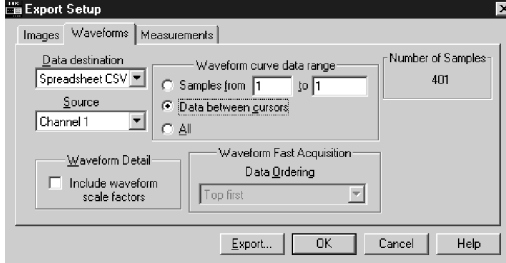
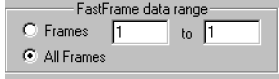
Overview	To export waveform data	Control elements and resources
<p>Prerequisites</p>	<ol style="list-style-type: none"> 1. The oscilloscope must be powered on. 2. Make sure the waveform, image, or measurement to be exported exists; that is, your source must be a channel, an active math waveform, an active reference, and so forth. 	 <ul style="list-style-type: none"> ■ See <i>Powering On the Oscilloscope</i> on page 1-8. ■ See page 3-25 for acquisition setup. ■ See page 3-49 for trigger setup.
<p>Select format for export</p>	<ol style="list-style-type: none"> 3. From the menu bar, select the File menu Select for Export submenu. The submenu lists all available waveform, image, and measurement types available for export: <ul style="list-style-type: none"> ■ Full Screen exports a bitmap of all screen contents ■ Graticule exports a bitmap of only the graticule area ■ Waveform exports waveform data ■ Measurements exports measurement data 	
<p>Select setup for export</p>	<ol style="list-style-type: none"> 4. From the menu bar, select the File menu Export Setup command. The Export Setup control window opens on the Images tab. 	

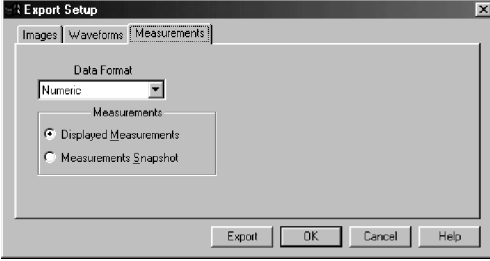
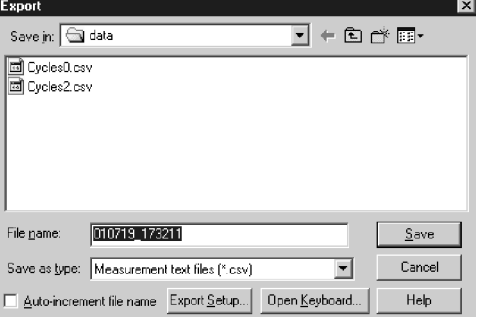
Overview	To export waveform data	Control elements and resources
<p>Set image export options</p>	<ol style="list-style-type: none"> 5. Select a color Palette for your exported images. 6. Select the imageView: to export an image of the entire screen, select Full-screen; to select an image of the selected graticule, select Graticule(s) only. 7. Select the type of image from the Image list. To export the image exactly as it appears on the screen, select Normal. To export the image on a white background, select Ink-saver Mode. 8. Select an image data format from the Data Format list. 	
<p>Set waveform export options</p>	<ol style="list-style-type: none"> 9. Select the Waveforms tab. 10. Select the data format (Data destination) for the waveform that you want to export. See <i>File Formats</i> on page 3-196 for information on the available formats. 11. Select a valid waveform from the Source list. 12. Select the Include waveform scale factors check box if you want to include waveform details like header information (record length, sample interval, trigger point information, and so on). If you only want to include the waveform voltage values, clear the selection. 13. Select the number of samples that you want to export from the Waveform curve data range. Select all samples, a range of samples, or only the samples between the cursors. If you select Data between cursors, you can use the multipurpose knobs to adjust the positions if the cursors are already active. If they are not, the cursors are activated in their most recent positions. 14. If you are using FastFrame, select the frame range to include in the exported files: <ul style="list-style-type: none"> ■ All Frames to include all frames in the exported files ■ Frames to enter a range of frames to include in the exported files 15. If you are exporting Fast Acquisitions data, select the data ordering from the list. 	 

Overview	To export waveform data	Control elements and resources
<p>Set measurement export options</p>	<p>16. Select the Measurements tab.</p> <p>17. Select the data format for the measurement that you want to export.</p> <p>18. Select Displayed Measurements to export all measurements that are displayed on screen, or Measurements Snapshot to export the current snapshot data. If there is no valid snapshot data, the default snapshot values are exported.</p> <p>19. Click OK to accept your changes, Cancel to close the window without making changes, or Help to access more information.</p>	
<p>Export data to a file</p>	<p>20. To export the data to a file, select the File menu Export command.</p> <p>21. Use the Save in: drop-down list and buttons to navigate to the directory in which to save your data.</p> <p>22. Select the file type in the Save as type: drop-down list to force the file listing to only include these types.</p> <p>23. Name your file. You can accept the default file name that appears in the File name: field, type a new name, or select an existing name from the file list (data in the existing file will be overwritten).</p> <p>Select the Auto-increment file name check box to save a series of files without typing in a new name each time. For more information, see <i>Using Auto-Increment File Name</i> on page 3-184.</p> <p>Tip. If you do not have an attached keyboard, click on Open Keyboard to display a virtual keyboard.</p> <p>24. Click the Save button to save the file. To cancel without saving a file, click Cancel button.</p>	 
<p>For further assistance</p>	<p>25. For more help on exporting files, access the online help.</p>	 <p>See page 3-209 to learn about using online help.</p>

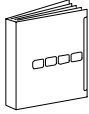
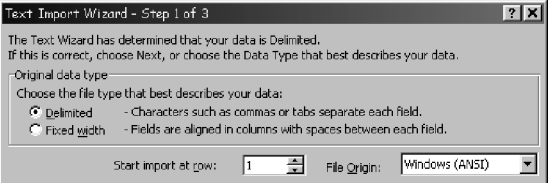
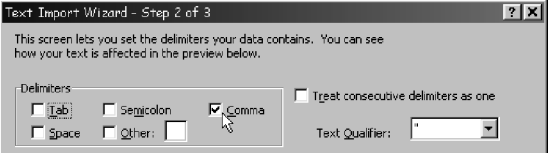
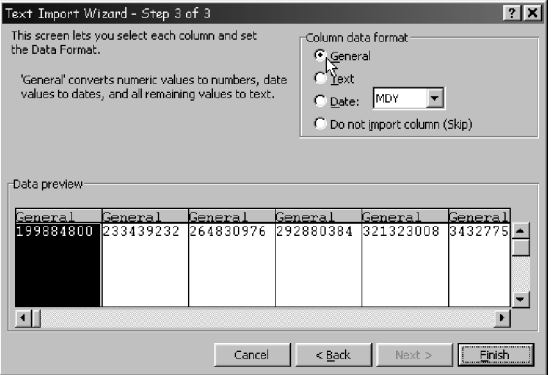

Using an Exported Waveform

How you use the exported waveform depends on your application. The following example is a simple application; the procedure is general and may require adapting for your spreadsheet or other data-analysis tool.

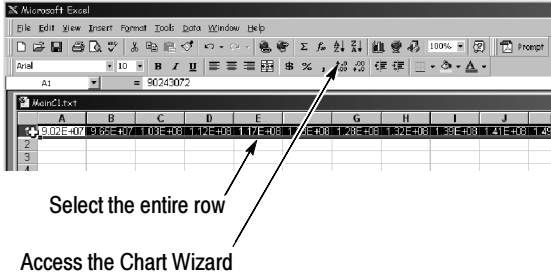
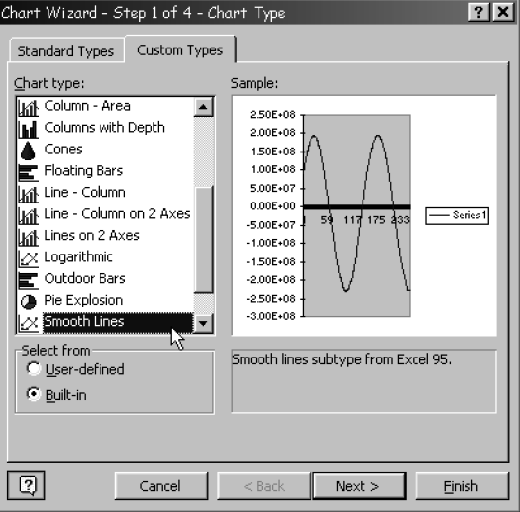
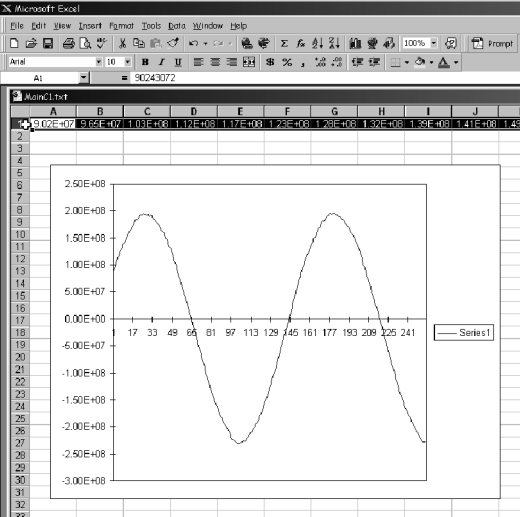
Overview	To use exported waveforms	Control elements and resources												
<p>Prerequisites</p>	<ol style="list-style-type: none"> MS Excel 97 running on a PC or on the oscilloscope. Access to a waveform exported by the oscilloscope. 	 <ul style="list-style-type: none"> See <i>Saving a Waveform</i> on page 3-190. 												
<p>Import the waveform data</p>	<ol style="list-style-type: none"> In Excel, select Open from the File menu. Use the window that pops up to navigate to the directory containing the file. In the dialog that displays, make the selections as shown at the right as you navigate through the Text Import Wizard. You must select delimiter as your data type, comma as the delimiter type, and General as your Column data format. <p>Tip. This step assumes MS Excel 97; your tool may have similar import features for comma-separated data. Check its documentation.</p> <p>Tip. To plot 2 channels, export the first channel with scale factors and time values. Export the second channel as voltages only.</p>	 <p>Text Import Wizard - Step 1 of 3</p> <p>The Text Wizard has determined that your data is Delimited. If this is correct, choose Next, or choose the Data Type that best describes your data.</p> <p>-Original data type-</p> <p>Choose the file type that best describes your data:</p> <p><input checked="" type="radio"/> Delimited - Characters such as commas or tabs separate each field.</p> <p><input type="radio"/> Fixed width - Fields are aligned in columns with spaces between each field.</p> <p>Start import at row: 1 File Origin: Windows (ANSI)</p>  <p>Text Import Wizard - Step 2 of 3</p> <p>This screen lets you set the delimiters your data contains. You can see how your text is affected in the preview below.</p> <p>Delimiters:</p> <p><input type="checkbox"/> Tab <input type="checkbox"/> Semicolon <input checked="" type="checkbox"/> Comma <input type="checkbox"/> Treat consecutive delimiters as one</p> <p><input type="checkbox"/> Space <input type="checkbox"/> Other: [] Text Qualifier: []</p>  <p>Text Import Wizard - Step 3 of 3</p> <p>This screen lets you select each column and set the Data Format.</p> <p>Column data format:</p> <p><input checked="" type="radio"/> General <input type="radio"/> Text <input type="radio"/> Date: MDY <input type="radio"/> Do not import column (Skip)</p> <p>'General' converts numeric values to numbers, date values to dates, and all remaining values to text.</p> <p>-Data preview-</p> <table border="1"> <thead> <tr> <th>General</th> <th>General</th> <th>General</th> <th>General</th> <th>General</th> <th>General</th> </tr> </thead> <tbody> <tr> <td>159684800</td> <td>233439232</td> <td>264830976</td> <td>292880384</td> <td>321323008</td> <td>3432775</td> </tr> </tbody> </table> <p>Cancel < Back Next > Finish</p>	General	General	General	General	General	General	159684800	233439232	264830976	292880384	321323008	3432775
General	General	General	General	General	General									
159684800	233439232	264830976	292880384	321323008	3432775									

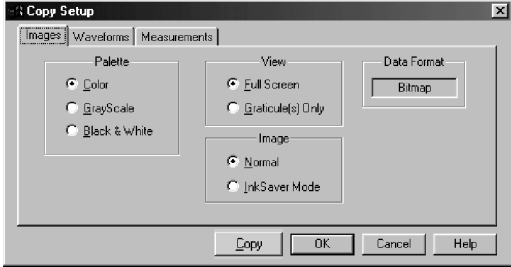
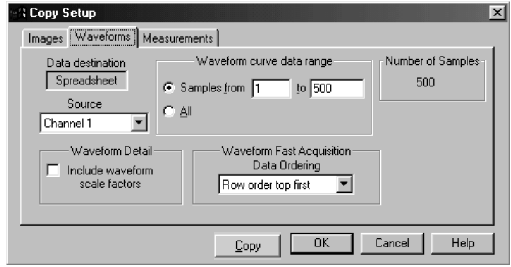
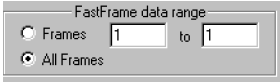
Overview	To use exported waveforms	Control elements and resources
<p>Begin your chart</p>	<ol style="list-style-type: none"> Click on the row number to select the entire row containing your imported waveform values. Select the Chart button from the toolbar or from the Insert menu. 	 <p>Select the entire row</p> <p>Access the Chart Wizard</p>
<p>Specify a line-graph chart</p>	<ol style="list-style-type: none"> From the Chart Wizard, make sure Built In is checked. Then select either Lines in the Standards Types tab or Smooth lines in the Custom Types tab. 	
<p>Finish the chart</p>	<ol style="list-style-type: none"> Click Next to step through the next two steps accepting the defaults setting at each step. Click the Finish button in step 4. You should have a waveform display similar to that show right. <p>Tip. This procedure assumes that you are using MS Excel 97. You can likely specify titles, customize the treatment and labeling of the x and y axes, and so forth in your data-analysis application—either as you create the chart or afterward. Use the help for your data-analysis application to determine if it has these capabilities and for instructions in using them.</p>	

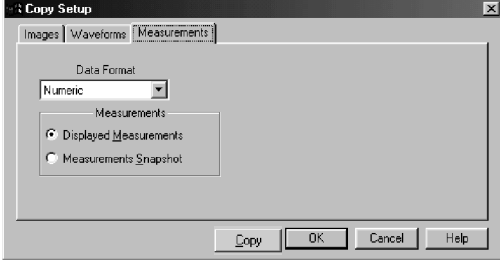
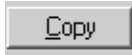
Overview	To copy data	Control elements and resources
<p>Set image copy options</p>	<ol style="list-style-type: none"> 4. Select a color Palette for your copied images. 5. Select the image View: to copy an image of the entire screen, select Full-screen; to copy an image of the selected graticule, select Graticule(s) only. 6. Select the type of image from the Image list. To copy the image exactly as it appears on the screen, select Normal. To copy the image on a white background, select Ink-saver Mode. 7. Select the Data Format, either BMP or JPG. 	
<p>Set waveform copy options</p>	<ol style="list-style-type: none"> 8. Select the Waveforms tab. 9. Select the data format (Data destination) for the waveform that you want to copy. 10. Select a valid waveform from the Source list. 11. Select the Include waveform scale factors check box if you want to include waveform details like header information (record length, sample interval, trigger point information, and so on). If you only want to include the waveform voltage values, clear the selection. 12. Select the number of samples that you want to copy from the Waveform curve data range. Select all samples, a range of samples, or only the samples between the cursors. If you select Data between cursors, you can use the multipurpose knobs to adjust the positions if the cursors are already active. If they are not, the cursors are activated in their most recent positions. 13. If you are using FastFrame, select the frame range to include in the exported files: <ul style="list-style-type: none"> ■ All Frames to include all frames in the exported files ■ Frames to enter a range of frames to include in the exported files 14. If you are copying Fast Acquisitions data, select the data ordering from the list. 	 

Overview	To copy data	Control elements and resources
<p>Set measurement copy options</p>	<p>15. Select the Measurements tab.</p> <p>16. Select the data format for the measurement that you want to copy.</p> <p>17. Select Displayed Measurements to copy all measurements that are displayed on screen, or Measurements Snapshot to copy the current snapshot data. If there is no valid snapshot data, the default snapshot values are copied.</p>	
<p>Copy the data</p>	<p>18. Click Copy to save your setup information. The copy operation takes place after you click Copy.</p>	
<p>For further assistance</p>	<p>19. For more help on copying files, access the online help.</p>	 <p>See page 3-209 to learn about using online help.</p>

Printing Waveforms

You can print the contents of the display screen, including any waveforms, to the optional built-in thermal printer, a printer attached to one of the rear-panel ports, or a network printer if your oscilloscope is on a network. You can print the full screen, just the graticule area, or a long continuous waveform as a banner. Banner printing shows more detail, drawing samples that might otherwise overlap on the screen. Banners can be printed on the integrated thermal printer only.

The oscilloscope uses Windows print drivers, so the process to install printers is the same as it is on any other PC.

Printing from the Front Panel

To print from the front panel, push the front-panel PRINT button. The display screen will print on the default printer. For additional print options, see the topics that follow.

Printing from the Menu Bar

To print a waveform from the application menu bar, select the File menu Print command. The standard Windows Print dialog box opens. The settings in the dialog box are dependent on the type of printer connected to the oscilloscope.

Setting Up the Page

To set the format of the printed page, select the File menu Page Setup command. The oscilloscope opens the Page Setup dialog box. The controls in this dialog box are similar to the Page Setup dialog box in most Windows applications. The Paper settings are dependent on the type of printer connected to the oscilloscope. A reduced preview image appears at the top of the window. To view a larger image, click Print Preview at the bottom of the window.

The Type of printing should be Screen-copy for all screen shots. Banner printing should only be used to print long continuous waveforms on the integrated thermal printer.

The Palette, View, and Image areas near the bottom of the window are identical to the settings under the Images tab of the Export Setup control window (see *Exporting Waveform Data* on page 3-197).

Previewing the Page

To preview your printout, select the File menu Print Preview command. The standard Windows Print Preview dialog box opens, as shown in Figure 3-60.

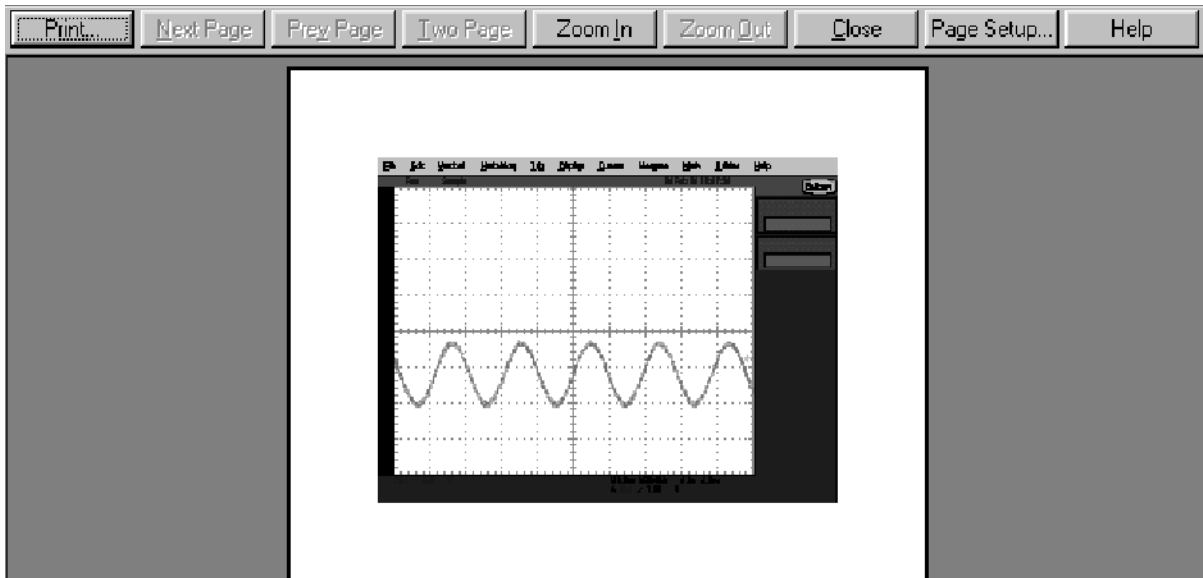

Figure 3-60: Print preview dialog box

Printing Banners

Banners can only be printed on the integrated thermal printer. When you open the Print dialog box from the File menu Print command, the Name text box should contain Integrated Thermal Printer, the default if you have this printer installed.

To print a banner, open the File menu Page Setup dialog box, and select Banner for the Type. This locks in values for the Orientation, View, and Image controls. For the Print Scale controls, select the Units you want to use to specify the horizontal scale, either inches/division or centimeters/division. Select a value for the Length; these values change according to the choice of Units.

Change the Summary Waveform selection if you want to add a screen shot to the Beginning, End, or Both ends of the banner. The Summary Waveform is a screen shot that gives you an overall view of what was originally on the screen before printing began. It contains information that will not appear on the banner, such as cursor and measurement readouts, histograms, and any screen text or labels that you have added.

Select the Samples to Print to specify which portion of the waveform to print. If you select Between cursors and no cursors are present, vertical cursors are activated in their most recent position. You can use the multipurpose knobs to change the cursor positions.

NOTE. If the banner you produce from the integrated thermal printer is unreadable because it is too light, open the printer cover and push the lever on the right side of the printer towards the back of the oscilloscope as far as it will go.

Banner printing is not compatible with:

- Fast Acquisition mode
- Persistence display mode
- XY or XYZ mode
- Zoom mode

Using Print Screen

If you have an attached keyboard, press the Print Screen (Prt Sc) key to copy the screen contents to the Windows clipboard. This bitmap does not include the waveforms or graticule. The waveforms and graticule are displayed by the graphics adapter outside of normal Windows mechanisms.

To capture the oscilloscope screen with its graticule and waveforms, use the Edit menu Copy command after selecting Image in the Copy Setup menu, or to build a bitmap file, select the File menu Export command after selecting Full Screen (bitmap) in the Select for Export menu. For additional information see *Exporting and Copying Waveforms* on page 3-196.

Using the Date/Time Stamp

You can display the current date and time on screen so that they appear on hard copies you print. To do this, toggle the Display Date/Time button On from the Display Setup control window Objects tab. If you need to reset the date and time for any reason, use the Utilities menu Set Date & Time command.

Remote Communication

GPIB Remote communication is performed through the GPIB (General Purpose Interface Bus). The product software CD-ROM contains the *TDS5000 Series Programmer Online Guide*, which consists of GPIB online help and PDF. Refer to this documentation for help with establishing remote control with your instrument (taking measurements, setting controls, performing calculations, and so on).

Use the Utilities menu GPIB Configuration command to open the GPIB Configuration control window. Click Talk/Listen to enable the GPIB. Click the Address control to map it to a multipurpose knob and use the knob to set the GPIB address for the oscilloscope. Click Off Bus to make the GPIB port unavailable.

Other Communication

For information on connecting the oscilloscope to a network to enable printing, file sharing, Internet access, and other communication functions, see *Connecting to a Network* on page 1-12.

Accessing Online Help

The online help system, integrated as part of the oscilloscope user interface, provides quick access to support information for operating this instrument. This section describes the help system and how to access it.

This oscilloscope provides the following help resources online:

- Help Topics
- *TDS5000 Series Oscilloscope Online Programmer Guide* (GPIB online help and a PDF file)

Much of the information you need to operate this oscilloscope and use it effectively is found online, where you can quickly access it and display it on your oscilloscope screen.

Remember the following when using online help:



- Use online help when you want to minimize interruption to your work flow. Help Topics are there when you need to probe more deeply into feature operation.
- Use the manuals for instructions on putting the oscilloscope into service, for procedures on reinstalling its product software, for listings of specifications, and for overviews of features and their operation.
- Use the online programmer guide (on the oscilloscope screen or on a connected PC) for support on operating the oscilloscope from the GPIB.

Using Online Help

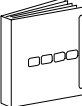
Use this procedure to access contextual help and search the help system for more information.

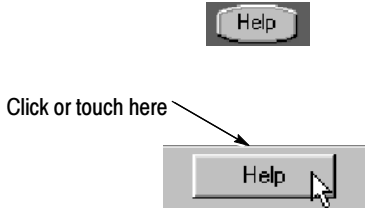
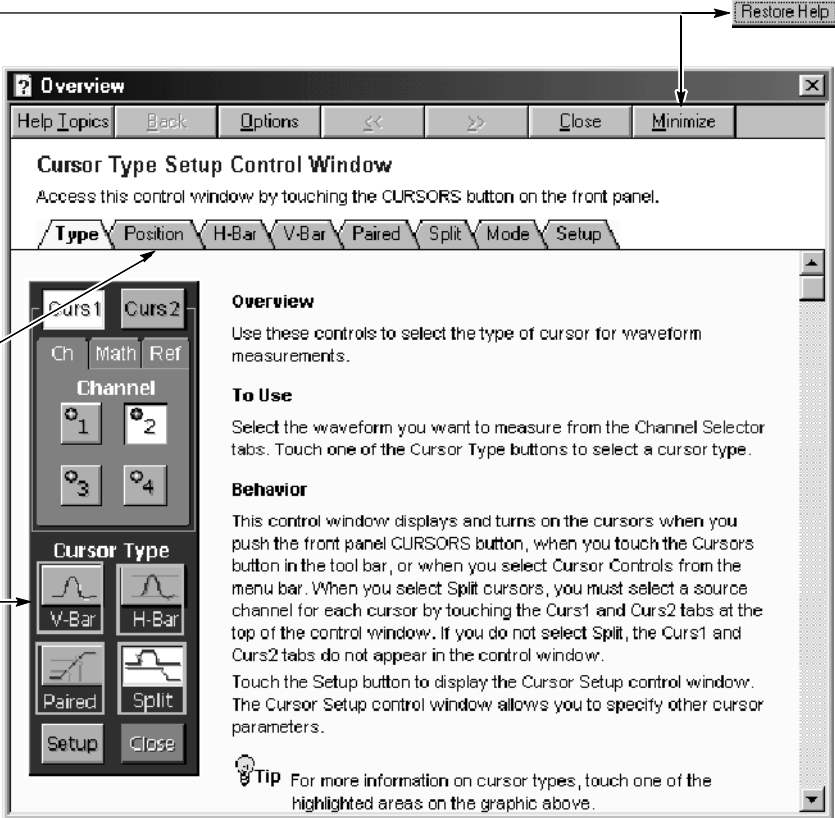
Overview	To use online help	Control elements and resources
Prerequisites	1. The oscilloscope must be powered up and running.	 <p>See <i>Powering On the Oscilloscope</i> on page 1-8</p>

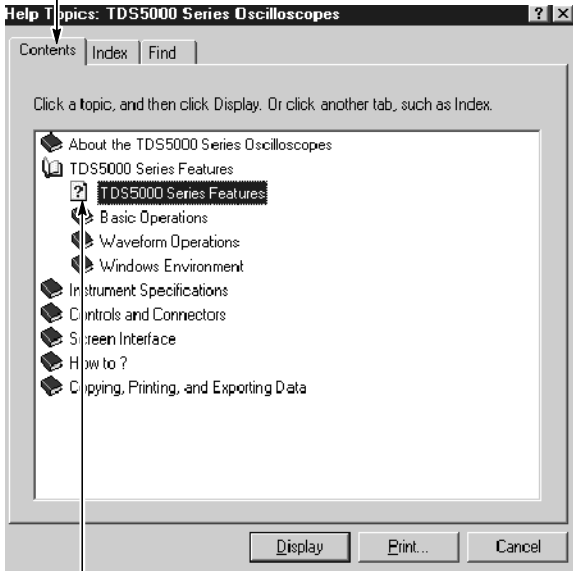
Overview	To use online help	Control elements and resources
<p>For in-depth, contextual overviews</p>	<ol style="list-style-type: none"> When using the toolbar and you have a control window displayed, touch the Help button to open the help system with an overview of the control window that is currently displayed. Some control windows contain a Help button. Click the button to open the help system with an overview of the control window that is currently displayed. You can also press the F1 key on an attached keyboard to access this type of help. <p>Click the Minimize button in a help window to move help out of the way so that you can operate the oscilloscope. Click the Restore Help button to see the last help topic again.</p> <p>Click a tab in a help window to navigate between the Overview and specific topics.</p> <p>Click an outlined control to receive more specific information about the control.</p>	 

Overview	To use online help	Control elements and resources
<p>Using WinHelp</p>	<p>4. You can search for help using methods that most users of PCs are familiar with: From the menu bar, select Help, and then select Contents and Index.</p> <p>5. From the online help finder, choose from the three tabs.</p>  <p>6. Click to explore the topic titles and to highlight one for display. Click the Display button to open the topic in a help window.</p>	

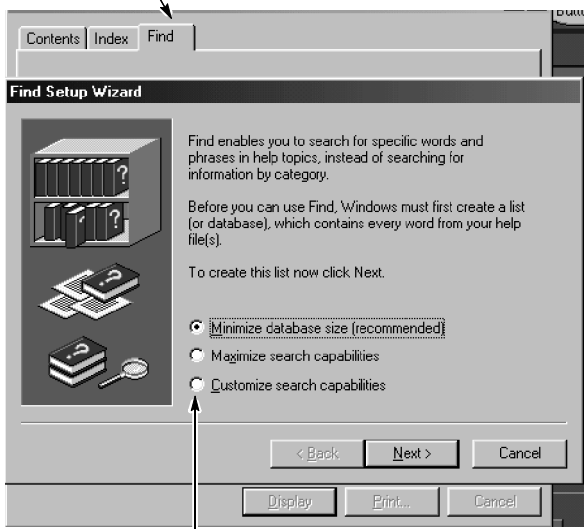
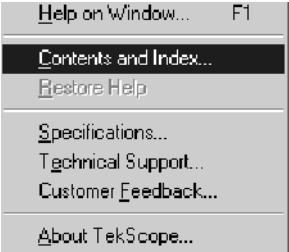
Overview	To use online help	Control elements and resources
<p>Enabling full-text search</p>	<p>7. If you cannot find the information in the Contents or Index tabs of the online finder, you may want to enable full text search: From the application menu bar, select Help, and then select Contents and Index. See right.</p> <p>8. From the online help finder (see below), choose the Find tab.</p>  <p>9. Choose the method for word list generation and select next or finish. Once the word list generation finishes, clicking the Find tab will access a pane for searching with full text search.</p>	

Appendix A: Specifications

This appendix contains the specifications for the TDS5000 series Digital Phosphor Oscilloscopes. All specifications are guaranteed unless labeled “typical.” Typical specifications are provided for your convenience but are not guaranteed.

All specifications apply to all TDS5000 models unless noted otherwise. To meet specifications, the following conditions must be met:

- The oscilloscope must have been calibrated in an ambient temperature between 20 °C and 30 °C (68 °F and 86 °F).
- The oscilloscope must be operating within the environmental limits listed in Table A-10 on page A-20.
- The oscilloscope must be powered from a source that meets the specifications listed in Table A-8 on page A-18.
- The oscilloscope must have been operating continuously for at least 20 minutes within the specified operating temperature range.
- You must perform the Signal Path Compensation procedure after the 20-minute warm-up period, and the ambient temperature must not change more than 5 °C (41 °F) without first repeating the procedure. See *Appendix E: Optimizing Measurement Accuracy* for instructions to perform this procedure.

Product and Feature Description

The TDS5000 Series Digital Phosphor Oscilloscope family consists of the models shown in Table A-1.

Table A-1: TDS5000 models

Model	Number of channels	Bandwidth	Maximum sample rate (real time)
TDS5052	2	500 MHz	5 GS/s
TDS5054	4	500 MHz	5 GS/s
TDS5104	4	1 GHz	5 GS/s

Acquisition Features

Separate Digitizers. Ensure accurate timing measurements with separate digitizers for each channel. The digitizers can also be combined to yield a higher sample rate on a single channel.

Fast Acquisition. Acquire up to 100,000 waveforms per second to see rapidly changing signals or intermittent signal irregularities.

Long Record Lengths. Choose record lengths from 500 points to up to 100,000 points per channel (up to 400,000 points on a single channel). Extend the maximum record length up to a maximum of 8,000,000 points with memory options.

Peak Detect Acquisition Mode. See pulses as narrow as 400 ps, even at the slower time base settings. Peak detect helps you see noise and glitches in your signal.

Acquisition Control. Acquire continuously or set up to capture single shot acquisitions. Enable or disable optional acquisition features such as equivalent time or roll mode.

Horizontal Delay. Use delay when you want to acquire a signal at a significant time interval after the trigger point. Toggle delay on and off to quickly compare the signal at two different points in time.

Signal Processing Features

Average, Envelope, and Hi Res Acquisition. Use Average acquisition mode to remove uncorrelated noise from your signal. Use Envelope to capture and display the maximum variation of the signal. Use Hi Res to increase vertical resolution for lower bandwidth signals.

Waveform Math. Set up simple math waveforms using the basic arithmetic functions including FFT, or create more advanced math waveforms using the optional math expression editor. Waveform expressions can even contain measurement results and other math waveforms.

Spectral Analysis. (Optional) Display spectral magnitude and phase waveforms based on your time-domain acquisitions. Control the oscilloscope using the traditional spectrum analyzer controls such as span and center frequency.

Display Features	Color LCD Display. Identify and differentiate waveforms easily with color coding. Waveforms, readouts, and inputs are color matched to increase productivity and reduce operating errors.
	Digital Phosphor. A Digital Phosphor Oscilloscope can clearly display intensity modulation in your signals. The oscilloscope automatically overlays subsequent acquisitions and then decays them to simulate the writing and decay of the phosphor in an analog oscilloscope CRT (cathode-ray tube). The feature results in an intensity-graded or color-graded waveform display that shows the information in the intensity modulation.
	Fit to Screen. The Digital Phosphor technology performs the compression required to represent all record points on the screen, even at the maximum record length settings.
	Zoom. To take advantage of the full resolution of the oscilloscope, you can zoom in on a waveform to see the fine details. Both vertical and horizontal zoom functions are available.
Measurement Features	Cursors. Use cursors to take simple voltage, time, and frequency measurements.
	Automatic Measurements. Choose from a large palette of amplitude, time, and histogram measurements. You can customize the measurements by changing reference levels or by adding measurement gating.
Trigger Features	Simple and Advanced Trigger Types. Choose a simple edge trigger, or choose from ten advanced trigger types to help you capture a specific signal fault or event.
	Dual Triggers. Use the A (main) trigger system alone or add the B trigger to capture more complex events. You can use the A and B triggers together to set up a delay-by-time or delay-by-events trigger condition.
Convenience Features	Autoset. Use Autoset to quickly set up the vertical, horizontal, and trigger controls for a usable display.
	Touch Screen Interface. (Optional) You can operate all oscilloscope functions (except the power switch) from the touch screen interface. You can also install a mouse and keyboard to use the interface.

Toolbar or Menu Bar. You can choose a toolbar operating mode that is optimized for use with the touch screen, or a PC-style menu-bar operating mode that is optimized for use with a mouse.

Open Desktop. The oscilloscope is built on a Microsoft Windows software platform; the oscilloscope application program starts automatically when you apply power to the instrument. You can minimize the oscilloscope application and take full advantage of the built-in PC to run other applications. Moving waveform images and data into other applications is as simple as a copy/paste operation.

Dedicated Front Panel Controls. The front panel contains knobs and buttons to provide immediate access to the most common oscilloscope controls. Separate vertical controls are provided for each channel. The same functions are also available through the screen interface.

Data Storage and I/O. The oscilloscope has a removable hard disk drive, a floppy disk drive, and a CD-ROM reader or optional CD-RW drive that can be used for storage and retrieval of data. The oscilloscope has GPIB, USB, Centronics, RS232, and Ethernet ports for input and output to other devices.

Integrated Thermal Printer (Optional). The optional built-in thermal printer allows you to print a long continuous waveform as a banner. Banner printing shows more detail, drawing samples that might otherwise overlap on the screen.

Online Help. The oscilloscope has a complete online help system that covers all its features. The help system is context sensitive; help for the displayed control window is automatically shown if you touch the help button. Graphical aids in the help windows assist you in getting to the information you need. You can also access the help topics through a table of contents or index.

Specification Tables

Table A-2: Channel input and vertical specifications

Characteristic	Description	
Input coupling	DC, AC, and GND	
Input channels	Two or four, all identical	
Input impedance, DC coupled	1 M Ω \pm 1.0% in parallel with 18 pF \pm 2 pF 50 Ω \pm 2.5%; VSWR \leq 1.6:1 from DC to 500 MHz (TDS5052/TDS5054), VSWR \leq 1.5:1 from DC to 1 GHz (TDS5104)	
Maximum voltage at input BNC (1 M Ω)	150 V _{RMS} CAT I, and \leq 400 peak For steady state sinusoidal waveforms, derate at 20 dB/decade above 200 kHz to 9 V _{RMS} at 3 MHz and above	
Maximum voltage at input BNC (50 Ω)	5 V _{RMS} , \pm 30 V peak	
Differential delay at input BNC	\leq 100 ps between any two channels with the same scale and coupling settings	
Deskew range, typical	\pm 75 ns	
Channel-to-channel crosstalk	\geq 100:1 at 100 MHz, and \geq 30:1 at the rated bandwidth for any two channels with the same scale and coupling settings	
Digitizers	8-bit resolution, separate digitizers for each channel sample simultaneously	
Sensitivity range	1 M Ω : 1 mV/div to 10 V/div, in a 1-2-5 sequence 50 Ω : 1 mV/div to 1 V/div, in a 1-2-5 sequence Fine adjustment available with \leq 1% resolution	
Analog bandwidth	DC 50 Ω coupling, bandwidth limit set to Full, operating ambient \leq 30 $^{\circ}$ C, derated by 2.5 MHz/ $^{\circ}$ C above 30 $^{\circ}$ C	
TDS5052/TDS5054	<i>SCALE range</i>	<i>Bandwidth</i>
	1 mV/div to 1.99 mV/div	DC to 175 MHz
	2 mV/div to 4.98 mV/div	DC to 300 MHz
	5 mV/div to 1 V/div	DC to 500 MHz
TDS5104	<i>SCALE range</i>	<i>Bandwidth</i>
	1 mV/div to 1.99 mV/div	DC to 175 MHz
	2 mV/div to 1 V/div	DC to 1 GHz
Analog bandwidth limit, typical	Selectable between 20 MHz, 150 MHz, or Full	

Table A-2: Channel input and vertical specifications (Cont.)

Characteristic	Description	
Lower frequency limit, AC coupled	< 10 Hz for 1 M Ω , reduced by a factor of ten when using a 10X probe; <200 kHz for 50 Ω	
Calculated rise time, typical	DC 50 Ω coupling, bandwidth limit set to Full	
TDS5052/TDS5054 TDS5104	<i>SCALE range</i>	<i>Rise time</i>
	1 mV/div to 1.99 mV/div	2.29 ns
	2 mV/div to 4.98 mV/div	1.33 ns
	5 mV/div to 1 V/div	800 ps
	<i>SCALE range</i>	<i>Rise time</i>
	1 mV/div to 1.99 mV/div	2.29 ns
	2 mV/div to 1 V/div	300 ps
Step response settling errors, typical	Bandwidth limit set to Full	
	<i>SCALE range and step amplitude</i>	<i>Settling error at time after step</i>
	1 mV/div to 99.5 mV/div, with \leq 2 V step	20 ns: \leq 0.5%
		100 ns: \leq 0.2%
		20 ms: \leq 0.1%
100 mV/div to 1 V/div, with \leq 20 V step	20 ns: \leq 1.0%	
	100 ns: \leq 0.5%	
	20 ms: \leq 0.2%	
1.01 V/div to 10 V/div, with \leq 200 V step	20 ns: \leq 1.0%	
	100 ns: \leq 0.5%	
	20 ms: \leq 0.2%	

Table A-2: Channel input and vertical specifications (Cont.)

Characteristic	Description			
Position range	± 5 divisions			
Offset range	1 M Ω coupling			
	<i>SCALE range</i>	<i>Offset range</i>		
	1 mV/div to 99.5 mV/div	±1 V		
	100 mV/div to 1V/div	±10 V		
	1.01 V/div to 10 V/div	±100 V		
	TDS5052/5054	50 Ω coupling		
		<i>SCALE range</i>	<i>Offset range</i>	
		1 mV/div to 99.5 mV/div	±1 V	
		100 mV/div to 1 V/div	±10 V	
		TDS5104	50 Ω coupling	
			<i>SCALE range</i>	<i>Offset range</i>
			1 mV/div to 50 mV/div	±0.5 V
			50.5 mV/div to 99.5 mV/div	±0.25 V
			100 mV/div to 500 mV/div	±5 V
505 mV/div to 1 V/div			±2.5 V	
Offset accuracy	<i>SCALE range</i>	<i>Offset range</i>		
	1 mV/div to 9.95 mV/div	$\pm \langle (0.2\% \times \text{net offset}) + 1.5 \text{ mV} + (0.1 \text{ div} \times \text{V/div setting}) \rangle$		
	10 mV/div to 99.5 mV/div	$\pm \langle (0.35\% \times \text{net offset}) + 1.5 \text{ mV} + (0.1 \text{ div} \times \text{V/div setting}) \rangle$		
	100 mV/div to 1 V/div	$\pm \langle (0.35\% \times \text{net offset}) + 15 \text{ mV} + (0.1 \text{ div} \times \text{V/div setting}) \rangle$		
	1.01 V/div to 10 V/div	$\pm \langle (0.25\% \times \text{net offset}) + 150 \text{ mV} + (0.1 \text{ div} \times \text{V/div setting}) \rangle$		
		At temperatures above 40 °C: $\pm \langle (0.75\% \times \text{Net Offset}) + 150 \text{ mV} + (0.1 \text{ div} \times \text{V/div setting}) \rangle$		
<i>where, net offset = offset - (position × volts/division)</i>				

Table A-2: Channel input and vertical specifications (Cont.)

Characteristic	Description	
DC gain accuracy, Sample or Average acquisition mode	$\pm 1.5\% + 1.0\% \times \text{net offset} / \text{offset range} $ TDS 5104 with 2 mV/div - 3.98 mV/div: $\pm 3\% + 1.0\% \times \text{net offset} / \text{offset range} $ Refer to <i>Offset Range</i> specifications	
DC voltage measurement accuracy	<i>Measurement type</i>	<i>DC accuracy (in volts)</i>
Sample acquisition mode, typical	Absolute measurement of any waveform point, and High, Low, Max, and Min measurements	$\pm [1.5\% + 1.0\% \times \text{net offset} / \text{offset range} \times \text{reading} - \text{net offset} + \text{offset accuracy} + 0.13 \text{ div} \times \text{V/div setting} + 0.6 \text{ mV}]$ TDS 5104 with 2 mV/div - 3.98 mV/div: $\pm [1.5\% + 3.0\% \times \text{net offset} / \text{offset range} \times \text{reading} - \text{net offset} + \text{offset accuracy} + 0.13 \text{ div} \times \text{V/div setting} + 0.6 \text{ mV}]$
	Delta voltage measurement between any two points acquired under the same setup and ambient conditions, and all other automatic measurements	$\pm [1.5\% + 1.0\% \times \text{net offset} / \text{offset range} \times \text{reading} - \text{net offset} + 0.26 \text{ div} \times \text{V/div setting} + 1.2 \text{ mV}]$ TDS5104 with 2 mV/div - 3.98 mV/div: $\pm [1.5\% + 3.0\% \times \text{net offset} / \text{offset range} \times \text{reading} - \text{net offset} + 0.26 \text{ div} \times \text{V/div setting} + 1.2 \text{ mV}]$
<i>where, net offset = offset - (position × volts/division)</i>		

Table A-2: Channel input and vertical specifications (Cont.)

Characteristic	Description	
Average acquisition mode (≥16 averages)	Absolute measurement of any waveform point, and High, Low, Max, and Min measurements	$\pm[1.5\% + 1.0\% \times \text{net offset /offset range} \times \text{reading} - \text{net offset} + 0.06 \text{ div} \times \text{V/div} + \text{offset accuracy}]$ TDS 5104 with 2 mV/div - 3.98 mV/div: $\pm[1.5\% + 3.0\% \times \text{net offset /offset range} \times \text{reading} - \text{net offset} + \text{offset accuracy} + 0.06 \text{ div} \times \text{V/div}]$
	Delta voltage measurement between any two points acquired under the same setup and ambient conditions, and all other automatic measurements	$\pm[1.5\% + 1.0\% \times \text{net offset /offset range} \times \text{reading} - \text{net offset} + 0.1 \text{ div} \times \text{V/div setting} + 0.3 \text{ mV}]$ TDS5104 with 2 mV/div - 3.98 mV/div: $\pm[1.5\% + 3.0\% \times \text{net offset /offset range} \times \text{reading} - \text{net offset} + 0.1 \text{ div} \times \text{V/div} + 0.3 \text{ mV}]$
<i>where, net offset = offset - (position × volts/division)</i>		
Nonlinearity, typical	< 1 LSB differential, < 1 LSB integral, independently based	

Table A-2: Channel input and vertical specifications (Cont.)

Characteristic	Description	
Effective bits, typical	Sine wave input at the indicated frequency and pk-pk amplitude, at 50 mV/division and 25 °C	
	<i>Signal and input conditions</i>	<i>Effective bits</i>
TDS5052, TDS5054	1 MHz, 9.2 div, 5 GS/s sample rate, Sample acquisition mode	6.8 bits
	1 MHz, 9.2 div, 10 MS/s sample rate, HiRes acquisition mode	9.1 bits
	500 MHz, 6.5 div, 5 GS/s sample rate, Sample acquisition mode	6.5 bits
TDS5104	1 MHz, 9.2 div, 5 GS/s sample rate, Sample acquisition mode	6.6 bits
	1 MHz, 9.2 div, 10 MS/s sample rate, HiRes acquisition mode	9.0 bits
	1 GHz, 6.5 div, 5 GS/s sample rate, Sample acquisition mode	4.7 bits

Table A-3: Horizontal and acquisition system specifications

Characteristic	Description	
Acquisition modes	Sample, Peak detect, Hi Res, Average, and Envelope	
Acquisition rate	Up to 100,000 waveforms per second in Fast Acquisition mode Up to 130 waveforms per second with Fast Acquisition off	
Minimum record length	500 points	
Maximum record length	Depends on the number of active channels and the amount of memory installed	
Standard	100,000 points (3 or 4 channels) 200,000 points (2 channels) 400,000 points (1 channel)	
Option 1M installed	500,000 points (3 or 4 channels) 1,000,000 points (2 channels) 2,000,000 points (1 channel)	
Option 2M installed	2,000,000 points (3 or 4 channels) 4,000,000 points (2 channels) 8,000,000 points (1 channel)	
Real-time sample rate range	<i>Number of channels acquired</i>	<i>Sample rate range</i>
	1	1.25 S/s to 5 GS/s
	2	1.25 S/s to 2.5 GS/s
	3 or 4	1.25 S/s to 1.25 GS/s
Equivalent-time sample rate or interpolated waveform rate range	2.5 GS/s to 250 GS/s Equivalent-time acquisition can be enabled or disabled. When disabled, waveforms are interpolated at the fastest time base settings.	
Seconds/division range	200 ps/div to 40 s/div	
Maximum FastFrame update rate, nominal	225,000 frames per second	
Horizontal delay range	16 ns to 250 s	
Long term sample rate and delay time accuracy	±15 ppm over any ≥ 1 ms interval	
RMS aperture uncertainty, typical	≤ [3 ps + (0.1 ppm × record duration)]	

Table A-3: Horizontal and acquisition system specifications (Cont.)

Characteristic	Description	
Delta time measurement accuracy	For a single channel, with signal amplitude > 5 div, reference level set at 50%, interpolation set to sin(x)/x, volts/division set to ≥ 5 mV/div, with (displayed risetime)/(sample interval) ratio between 1.4 and 4, where sample interval = 1/(real-time sample rate)	
	<i>Conditions</i>	<i>Accuracy</i>
	Single shot signal, Sample or Hi Res acquisition mode, Full bandwidth	$\pm (15 \text{ ppm} \times \text{reading} + 0.3 \text{ sample intervals})$
Average acquisition mode, ≥ 100 averages, Full bandwidth	$\pm (15 \text{ ppm} \times \text{reading} + 20 \text{ ps})$	

Table A-4: Trigger specifications

Characteristic	Description	
Auxiliary input resistance, typical	$\geq 1.5 \text{ k}\Omega$	
Maximum auxiliary input voltage	$\pm 20 \text{ V}$ (DC or peak AC)	
Edge Trigger Sensitivity	<i>Trigger Source</i>	<i>Sensitivity</i>
TDS5052, TDS5054	Any channel, DC coupled	0.35 div from DC to 50 MHz, increasing to 1 div at 500 MHz
	Auxiliary input	400 mV from DC to 50 MHz, increasing to 750 mV at 100 MHz
TDS5104	Any channel, DC coupled	0.35 div from DC to 50 MHz, increasing to 1 div at 1 GHz
	Auxiliary input	400 mV from DC to 50 MHz, increasing to 750 mV at 100 MHz
Edge trigger sensitivity, typical	All sources, for vertical scale settings $\geq 10 \text{ mV/div}$ and $\leq 1 \text{ V/div}$	
	<i>Trigger coupling</i>	<i>Sensitivity</i>
	NOISE REJ	$3 \times$ the DC-coupled limits
	AC	Same as DC-coupled limits for frequencies $\geq 60 \text{ Hz}$, attenuates signals $< 60 \text{ Hz}$
	HF REJ	$1.5 \times$ the DC-coupled limits from DC to 30 kHz, attenuates signals $> 30 \text{ kHz}$
	LF REJ	$1.5 \times$ the DC-coupled limits for frequencies $\geq 80 \text{ kHz}$, attenuates signals $< 80 \text{ kHz}$
Advanced trigger sensitivity, typical	For all trigger types except Edge, with vertical scale settings $\geq 10 \text{ mV/div}$ and $\leq 1 \text{ V/div}$ 1.0 div, from DC to 500 MHz	
Event count sensitivity, typical	For sequential trigger delayed by events, with vertical scale settings $\geq 10 \text{ mV/div}$ and $\leq 1 \text{ V/div}$ 1.0 div, from DC to 500 MHz	
Trigger level or threshold range	<i>Trigger Source</i>	<i>Sensitivity</i>
	Any channel	± 10 divisions from center of screen
	Auxiliary input	$\pm 8 \text{ V}$
	Line	fixed at zero volts

Table A-4: Trigger specifications (Cont.)

Characteristic	Description		
Trigger level or threshold accuracy, typical	Edge trigger, DC coupling, for signals having rise and fall times ≤ 20 ns		
	<i>Trigger Source</i>	<i>Accuracy</i>	
	Any channel	$\pm [(2\% \times \text{setting} - \text{net offset}) + (0.3 \text{ div} \times \text{volts/div setting}) + \text{offset accuracy}]$	
	Auxiliary	Not calibrated or specified	
	<i>where, net offset = offset - (position \times volts/division)</i>		
Set level to 50% function	Operates with signals ≥ 30 Hz		
Trigger position error, typical	Edge trigger, DC coupling, for signals having a slew rate at the trigger point of ≥ 0.5 div/ns		
	<i>Acquisition mode</i>	<i>Error</i>	
	Sample, Average	$\pm (1 \text{ displayed point} + 1 \text{ ns})$	
	Envelope	$\pm (2 \text{ displayed points} + 1 \text{ ns})$	
Trigger jitter, typical	$\sigma = 8$ ps RMS		
B Event (Delayed) trigger	<i>Trigger After Time</i>	<i>Trigger on n^{th} Event</i>	
	Range	Delay time = 16 ns to 250 s	Event count = 1 to 10^7
	Minimum time between arm (A Event) and trigger (B Event), typical	2 ns from the end of the time period to the B trigger event	2 ns between the A trigger event and the first B trigger event
	Minimum pulse width, typical	—	B event width ≥ 1 ns
	Maximum frequency, typical	—	B event frequency ≤ 500 MHz

Table A-4: Trigger specifications (Cont.)

Characteristic	Description	
Advanced trigger timing	For vertical scale settings ≥ 10 mV/div and ≤ 1 V/div	
	<i>Minimum recognizable event width or time</i>	<i>Minimum re-arm time to recognize next event</i>
Glitch type	Minimum glitch width = 1 ns	2 ns + 5% of glitch width setting
Runt or Window type	Minimum runt width = 2 ns	2 ns
Runt or Window type (time qualified)	Minimum runt width = 2 ns	8.5 ns + 5% of runt width setting
Runt or Window type (logic qualified)	Minimum runt width = 2 ns	8.5 ns + 5% of runt width setting
Width type	Minimum difference between upper and lower limits = 1 ns	2 ns + 5% of upper limit setting
Timeout type	Minimum timeout time = 1 ns	2 ns + 5% of timeout setting
Transition type	Minimum transition time = 600 ps	8.5 ns + 5% of transition time setting
Pattern type, typical	Minimum time the pattern is true = 1 ns	1 ns
State type, typical	Minimum true time before clock edge = 1 ns	1 ns
	Minimum true time after clock edge = 1 ns	
Setup/Hold type, typical	<i>Minimum clock pulse width from active edge to inactive edge</i>	<i>Minimum clock pulse width from inactive edge to active edge</i>
	3 ns + hold time setting	2 ns
	<i>Setup and Hold parameters</i>	<i>Limits</i>
	Setup time (time from data transition to clock edge)	-100 ns minimum +100 ns maximum
	Hold time (time from clock edge to data transition)	-1 ns minimum +102 ns maximum
	Setup time + Hold time (algebraic sum of the two settings)	+2 ns minimum +202 ns maximum
Advanced trigger timer ranges	<i>Limits</i>	
Glitch type	1 ns to 1 s	

Table A-4: Trigger specifications (Cont.)

Characteristic	Description	
Runt or Window type, wider than	1 ns to 1 s	
Runt or Window type, time qualified	1 ns to 1 s	
Width type	1 ns to 1 s	
Timeout type	1 ns to 1 s	
Transition type	1 ns to 1 s	
Pattern type	1 ns to 1 s	
Setup/Hold type	<i>Setup and Hold timers</i>	<i>Limits</i>
	Setup time (time from data transition to clock edge)	-100 ns to +100 ns
	Hold time (time from clock edge to data transition)	-1 ns to +100 ns
	Setup time + Hold time (algebraic sum of the two settings)	+2 ns to +200 ns
Advanced trigger timer accuracy	For Glitch, Timeout, or Width types	
	<i>Time range</i>	<i>Accuracy</i>
	1 ns to 500 ns	±(20% of setting + 0.5 ns)
	520 ns to 1 s	±(0.01% of setting + 100 ns)
Trigger holdoff range	1.5 μs to 12 s, minimum resolution is 8 μs for settings ≤1.2 ms	

Table A-5: Display specifications

Characteristic	Description
Display type	211.2 mm (8.3 in) width × 158.4 mm (6.2 in) height, 264 mm (10.4 in) diagonal, liquid crystal active-matrix color display
Display resolution	640 horizontal × 480 vertical pixels
Pixel pitch	0.33 mm horizontal, 0.33 mm vertical
Contrast ratio, typical	150:1
Response time, typical	50 ms, black to white
Display refresh rate	59.94 frames per second
Displayed intensity levels	Supports Windows SVGA high-color mode (16- or 24-bit)

Table A-6: Input/output port specifications

Characteristic	Description	
Probe Compensator Output	Front-panel terminals	
	<i>Output voltage</i>	<i>Frequency</i>
	1.0 V (from base to top) \pm 1.0% into a $\geq 10\text{ k}\Omega$ load	1 kHz \pm 5%
Analog Signal Output amplitude	Rear-panel BNC connector, provides a buffered version of the signal that is attached to the channel 3 input 20 mV/div \pm 20% into a 1 M Ω load 10 mV/div \pm 20% into a 50 Ω load	
Analog Signal Output bandwidth, typical	100 MHz into a 50 Ω load	
Auxiliary Output levels	Rear-panel BNC connector, provides a TTL-compatible, negative-polarity pulse for each A or B trigger (selectable)	
	<i>V_{out high}</i>	<i>V_{out low (true)}</i>
	$\geq 2.5\text{ V}$ into open circuit, $\geq 1.0\text{ V}$ into 50 Ω load	$\leq 0.7\text{ V}$ with $\leq 4\text{ ma}$ sink, $\leq 0.25\text{ V}$ into 50 Ω load
Auxiliary Output pulse width, typical	Pulse width varies, 1 μs minimum	
External Reference Input	Rear-panel BNC connector	
	9.8 MHz to 10.2 MHz	
	200 mV p-p to 7 V p-p	
	$>1.5\text{k}\Omega$ in series with $\sim 10\text{ nf}$ DC blocking capacitor	

Table A-6: Input/output port specifications (Cont.)

Characteristic	Description
Side-panel I/O ports	Ports located on the rear panel
Parallel port (IEEE 1284)	DB-25 connector, supports the following modes: -standard (output only) bidirectional (PS-2 compatible) bidirectional enhanced parallel port (IEEE 1284 standard, mode 1 or mode 2, v 1.7) -bidirectional high-speed extended capabilities
Audio ports	Miniature phone jacks for stereo microphone input and stereo line output
USB port (2)	Allows connection or disconnection of USB keyboard, mouse and/or other devices while scope power is on
Keyboard port	PS-2 compatible, oscilloscope power must be off to make connection
Mouse port	PS-2 compatible, oscilloscope power must be off to make connection
LAN port	RJ-45 connector, supports 10 base-T and 100 base-T
Serial port	DB-9 COM1 port, uses NS16C550-compatible UARTS, transfer speeds up to 115.2 kb/s
SVGA video port	Upper video port, DB-15 female connector, connect a second monitor to use dual-monitor display mode, supports Basic requirements of PC99 specifications
GPIB port	IEEE 488.2 standard interface
Scope VGA video port	Lower video port, DB-15 female connector, 31.6 kHz sync, EIA RS-343A compliant, connect to show the oscilloscope display, including live waveforms, on an external monitor

Table A-7: Data storage specifications

Characteristic	Description
CD-ROM	Side-panel CD-ROM drive, read only. CD-RW optional
Floppy disk	Front-panel 3.5 in floppy disk drive, 1.44 MB capacity
Hard disk	Internal hard disk drive, \geq 20 GB capacity

Table A-8: Power source specifications

Characteristic	Description
Source voltage and frequency	100 to 240 V \pm 10%, 47 Hz to 63 Hz
Power consumption	\leq 220 W
Overvoltage Category	Overvoltage Category II (as defined in IEC61010-1/A2)

Table A-9: Mechanical specifications

Characteristic	Description												
Weight													
Benchtop configuration	22 lbs (10 kg) oscilloscope only 55 lbs (25 kg) when packaged for domestic shipment												
Rackmount kit	4 lbs (1.8 kg) rackmount conversion kit 11 lbs (5 kg) kit packaged for domestic shipment												
Dimensions													
Benchtop configuration	11.2 in (284.5 mm) height, 12.8 in (325.1 mm) with feet extended 17.6 in (447 mm) width 11.35 in (288.3 mm) depth												
Rackmount configuration (Option 1R)	10.5 in (267 mm) height 19 in (483 mm) width 11.35 in (288.3 mm) depth												
Cooling	Fan-forced air circulation with no air filter.												
Required clearances	<table border="1"> <tbody> <tr> <td>Top</td> <td>0 in (0 mm)</td> </tr> <tr> <td>Bottom</td> <td>0.25 in (6.5 mm) minimum or 0 in (0 mm) when stand- ing on the feet</td> </tr> <tr> <td>Left side</td> <td>3 in (76 mm)</td> </tr> <tr> <td>Right side</td> <td>0 in 5 in (126 mm) required to access CD-ROM</td> </tr> <tr> <td>Front</td> <td>0 in (0 mm)</td> </tr> <tr> <td>Rear</td> <td>0 in (0 mm)</td> </tr> </tbody> </table>	Top	0 in (0 mm)	Bottom	0.25 in (6.5 mm) minimum or 0 in (0 mm) when stand- ing on the feet	Left side	3 in (76 mm)	Right side	0 in 5 in (126 mm) required to access CD-ROM	Front	0 in (0 mm)	Rear	0 in (0 mm)
Top	0 in (0 mm)												
Bottom	0.25 in (6.5 mm) minimum or 0 in (0 mm) when stand- ing on the feet												
Left side	3 in (76 mm)												
Right side	0 in 5 in (126 mm) required to access CD-ROM												
Front	0 in (0 mm)												
Rear	0 in (0 mm)												
Construction material	Chassis parts are constructed of aluminum alloy, front panel is constructed of plastic laminate, circuit boards are constructed of glass laminate, outer shell is molded and textured from a polycarbonate/ABS blend												

Table A- 10: Environmental specifications

Characteristic	Description
Temperature	
Operating	+5 °C to +45 °C
Nonoperating	-20 °C to +60 °C
Humidity	
Operating	20% to 80% relative humidity with a maximum wet bulb temperature of +29 °C at or below +45 °C, noncondensing Upper limit derated to 30% relative humidity at +45 °C
Nonoperating	With no diskette in floppy disk drive 5% to 90% relative humidity with a maximum wet bulb temperature of +29 °C at or below +60 °C, noncondensing Upper limit derated to 20% relative humidity at +60 °C
Altitude	
Operating	10,000 ft (3,048 m)
Nonoperating	40,000 ft (12,190 m)
Random vibration	
Operating	0.22 g _{RMS} from 5 Hz to 500 Hz, 10 minutes on each axis
Nonoperating	2.28 g _{RMS} from 5 Hz to 500 Hz, 10 minutes on each axis
Shock, nonoperating	30 g (11 ms half-sine wave or less)

Table A- 11: Certifications and compliances

Category	Standards or description
EC Declaration of Conformity - EMC	<p>Meets intent of Directive 89/336/EEC for Electromagnetic Compatibility. Compliance was demonstrated to the following specifications as listed in the Official Journal of the European Union:</p> <p>EN 61326 Emissions^{1, 3} Class A Radiated and Conducted Emissions</p> <p>EN 61326 Immunity ^{1, 2, 4}</p> <p>IEC 61000-4-2 Electrostatic Discharge Immunity ± 4 kV contact discharge, ± 8 kV air discharge, performance criterion C</p> <p>IEC 61000-4-3 RF field immunity 3 V/m, 80 MHz to 1 GHz, 80% amplitude modulated with a 1 kHz sinewave performance criterion A</p> <p>IEC 61000-4-4 Electrical Fast Transient/Burst Immunity 1 kV on AC mains, 500 V on I/O cables, performance criterion C</p> <p>IEC 61000-4-5 AC Surge Immunity 500 V differential mode, 1 kV common mode, performance criterion B</p> <p>IEC 61000-4-6 RF Conducted Immunity 3 V, 150 kHz to 80 MHz, amplitude modulated with a 1 kHz sinewave, performance criterion A</p> <p>IEC 61000-4-11 AC Mains Voltage Dips and Interruption Immunity 100% reduction for one cycle, performance criterion B</p> <p>EN 61000-3-2 Power Harmonic Current Emissions</p> <p>¹ If interconnect cables are used, they must be low-EMI shielded cables such as the following Tektronix part numbers or their equivalents: 012-0991-01, 012-0991-02 or 012-0991-03 GPIB Cable; 012-1213-00 (or CA part number 0294-9) RS-232 Cable; 012-1214-00 Centronics Cable; or LCOM part number CTL3VGAMM-5 VGA Cable.</p> <p>² The performance criteria for when the oscilloscope is subjected to the conditions described above are defined as follows: A — ≤ 0.2 division waveform displacement or ≤ 0.4 division increase in peak-to-peak noise B — temporary, self-recoverable degradation or loss of performance is allowed, but no change of actual operating state or loss of stored data is allowed C — temporary loss of function is allowed provided that the function is self recoverable or can be restored by the operation of the controls</p> <p>³ Radiated emissions may exceed the levels specified in EN 61326 when this oscilloscope is connected to a test object.</p> <p>⁴ USB mouse and keyboard only, performance criterion C. Normal USB keyboard or mouse operation can be restored by unplugging and reconnecting the USB connector to the oscilloscope. If the USB mouse, front-panel controls, or touch screen do not respond, press the On/Standby switch for five seconds to cycle power.</p>
FCC	Radiated and conducted emissions do not exceed the levels specified in FCC47 CFR, Part 15, Subpart B, for Class A equipment.

Table A- 11: Certifications and compliances (cont.)

Category	Standards or description
EC Declaration of Conformity - Low Voltage	<p>Compliance was demonstrated to the following specification as listed in the Official Journal of the European Union:</p> <p>Low Voltage Directive 73/23/EEC, amended by 93/68/EEC</p> <p>EN 61010-1/A2:1995 Safety requirements for electrical equipment for measurement control and laboratory use.</p>
U.S. Nationally Recognized Testing Laboratory Listing	<p>UL3111-1, First Edition Standard for electrical measuring and test equipment.</p>
Canadian Certification	<p>CAN/CSA C22.2, No. 1010.1-92 Safety requirements for electrical equipment for measurement, control, and laboratory use.</p>
Additional Compliance	<p>IEC61010-1/A2 Safety requirements for electrical equipment for measurement, control, and laboratory use.</p>
Installation (Overvoltage) Category	<p>Terminals on this product may have different installation (overvoltage) category designations. The installation categories are:</p> <p>CAT III Distribution-level mains (usually permanently connected). Equipment at this level is typically in a fixed industrial location.</p> <p>CAT II Local-level mains (wall sockets). Equipment at this level includes appliances, portable tools, and similar products. Equipment is usually cord-connected.</p> <p>CAT I Secondary (signal level) or battery operated circuits of electronic equipment.</p>
Pollution Degree	<p>A measure of the contaminates that could occur in the environment around and within a product. Typically the internal environment inside a product is considered to be the same as the external. Products should be used only in the environment for which they are rated.</p> <p>Pollution Degree 2 Normally only dry, nonconductive pollution occurs. Occasionally a temporary conductivity that is caused by condensation must be expected. This location is a typical office/home environment. Temporary condensation occurs only when the product is out of service.</p>
Safety Certification Compliance	
Equipment Type	Test and measuring
Safety Class	Class 1 (as defined in IEC 61010-1/A2) - grounded product
Pollution Degree	Pollution Degree 2 (as defined in IEC 61010-1/A2). Note: Rated for indoor use only.

Appendix B: Automatic Measurements Supported

This appendix provides a list of all supported measurements and their definitions. An illustration showing the levels used to take measurements is also included.

Table B-1: Supported measurements and their definitions













Name	Definition
 Amplitude	Voltage measurement. The high value less the low value measured over the entire waveform or gated region. <i>Amplitude = High-Low</i>
 Area	Area measurement (Voltage over time measurement). The area over the entire waveform or gated region in volt-seconds. Area measured above ground is positive; area below ground is negative.
 Cycle Area	Voltage over time measurement. The area over the first cycle in the waveform, or the first cycle in the gated region, in volt-seconds. Area measured above ground is positive; area below ground is negative.
 Burst Width	Timing measurement. The duration of a burst. Measured over the entire waveform or gated region.
 Cycle Mean	Voltage measurement. The arithmetic mean over the first cycle in the waveform or the first cycle in the gated region.
 Cycle RMS	Voltage measurement. The true Root Mean Square voltage over the first cycle in the waveform or the first cycle in the gated region.
 Delay	Timing measurement. The time between the MidRef crossings of two different traces or the gated region of the traces.
 Fall Time	Timing measurement. Time taken for the falling edge of the first pulse in the waveform or gated region to fall from a High Ref value (default = 90%) to a Low Ref value (default = 10%) of its final value.
 Frequency	Timing measurement for the first cycle in the waveform or gated region. The reciprocal of the period. Measured in hertz (Hz) where 1 Hz = 1 cycle per second.
 High	The value used as 100% whenever High Ref, Mid Ref, and Low Ref values are needed (as in fall time and rise time measurements). Calculated using either the min/max or the histogram method. The <i>min/max</i> method uses the maximum value found. The <i>histogram</i> method uses the most common value found above the mid point. Measured over the entire waveform or gated region.
 Low	The value used as 0% whenever High Ref, Mid Ref, and Low Ref values are needed (as in fall time and rise time measurements). May be calculated using either the min/max or the histogram method. With the min/max method it is the minimum value found. With the histogram method, it refers to the most common value found below the midpoint. Measured over the entire waveform or gated region.
 Maximum	Voltage measurement. The maximum amplitude. Typically the most positive peak voltage. Measured over the entire waveform or gated region.
 Mean	Voltage measurement. The arithmetic mean over the entire waveform or gated region.

Table B-1: Supported measurements and their definitions (Cont.)

























Name	Definition
 Minimum	Voltage measurement. The minimum amplitude. Typically the most negative peak voltage. Measured over the entire waveform or gated region.
 Negative Duty Cycle	Timing measurement of the first cycle in the waveform or gated region. The ratio of the negative pulse width to the signal period expressed as a percentage. $NegativeDutyCycle = \frac{NegativeWidth}{Period} \times 100\%$
 Negative Overshoot	Voltage measurement. Measured over the entire waveform or gated region. $NegativeOvershoot = \frac{Low-Min}{Amplitude} \times 100\%$
 Negative Width	Timing measurement of the first pulse in the waveform or gated region. The distance (time) between MidRef (default 50%) amplitude points of a negative pulse.
 Peak to Peak	Voltage measurement. The absolute difference between the maximum and minimum amplitude in the entire waveform or gated region.
 Phase	Timing measurement. The amount one waveform leads or lags another in time. Expressed in degrees, where one waveform cycle is 360°.
 Period	Timing measurement. Time it takes for the first complete signal cycle to happen in the waveform or gated region. The reciprocal of frequency. Measured in seconds.
 Positive Duty Cycle	Timing measurement of the first cycle in the waveform or gated region. The ratio of the positive pulse width to the signal period expressed as a percentage. $PositiveDutyCycle = \frac{PositiveWidth}{Period} \times 100\%$
 Positive Overshoot	Voltage measurement over the entire waveform or gated region. $PositiveOvershoot = \frac{Max-High}{Amplitude} \times 100\%$
 Positive Width	Timing measurement of the first pulse in the waveform or gated region. The distance (time) between MidRef (default 50%) amplitude points of a positive pulse.
 Rise time	Timing measurement. Time taken for the leading edge of the first pulse in the waveform or gated region to rise from a Low Ref value (default = 10%) to a High Ref value (default = 90%) of its final value.
 RMS	Voltage measurement. The true Root Mean Square voltage over the entire waveform or gated region.
Histogram Measurements (Optional)	
 Mean	The average of all acquired points within (or on) the histogram box.
 Median	Half of all acquired points within (or on) the histogram box are less than and half are greater than this value.
 StdDev	The standard deviation (Root Mean Square (RMS) deviation) of all acquired points within (or on) the histogram box.
 Hits in Box	Displays the number of points in the histogram box or on the box boundary.

Table B-1: Supported measurements and their definitions (Cont.)

Name	Definition
 Waveform Count	Displays the number of waveforms that have contributed to the histogram.
 Peak Hits	Displays the number of points in the largest bin of the histogram.
 Pk-Pk	Displays the peak-to-peak value of the histogram. Vertical histograms display the “voltage” of the highest nonzero bin minus the “voltage” of the lowest nonzero bin. Horizontal histograms display the “time” of the rightmost nonzero bin minus the “time” of the leftmost nonzero bin (Max - Min).
 Max	Displays the maximum voltage or time.
 Min	Displays the minimum voltage or time.
 Mean ± 1 StdDev	The percentage of points in the histogram which are within 1 standard deviation of the histogram mean.
 Mean ± 2 StdDev	The percentage of points in the histogram which are within 2 standard deviations of the histogram mean.
 Mean ± 3 StdDev	The percentage of points in the histogram which are within 3 standard deviations of the histogram mean.

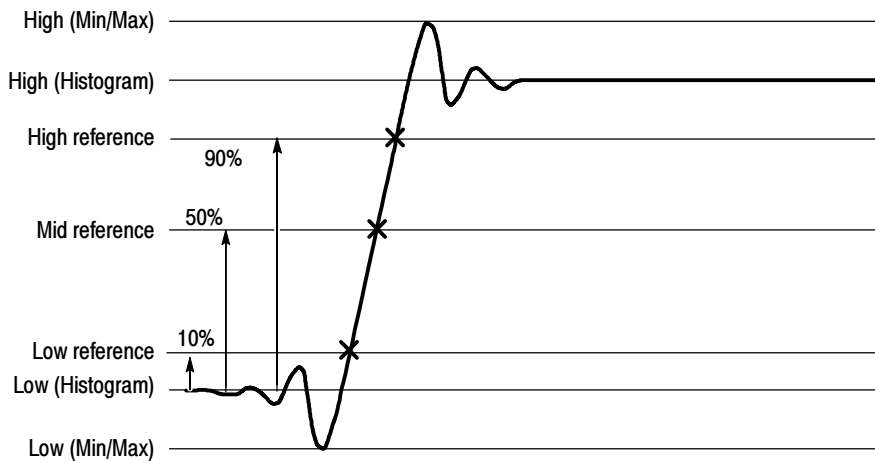

Figure B-1: Levels used to determine measurements

Appendix C: Cleaning

Use these procedures to clean your oscilloscope. If additional cleaning is required, have your oscilloscope serviced by qualified service personnel.

Exterior Cleaning

Clean the exterior surfaces of the chassis with a dry lint-free cloth or a soft-bristle brush. If any dirt remains, use a cloth or swab dipped in a 75% isopropyl alcohol solution. Use a swab to clean narrow spaces around controls and connectors. Do not use abrasive compounds on any part of the chassis.

Clean the On/Standby switch using a dampened cleaning towel. Do not spray or wet the switch directly.



CAUTION. Do not use chemical cleaning agents that might damage the plastics used in this oscilloscope. Use only deionized water when cleaning the front-panel buttons. Use a 75% isopropyl alcohol solution as a cleaner and rinse with deionized water. Before using any other type of cleaner, consult your Tektronix Service Center or representative.

To prevent getting moisture inside the oscilloscope during external cleaning, use only enough liquid to dampen the cloth or applicator.

Flat Panel Display Cleaning

The display is soft plastic and must be treated with care during cleaning.



CAUTION. Improper cleaning agents or methods can damage the flat panel display.

Do not use abrasive cleaners or commercial glass cleaners to clean the display surface.

Do not spray liquids directly on the display surface.

Do not scrub the display with excessive force.

Clean the flat panel display surface by gently rubbing the display with a clean-room wipe (such as Wypall Medium Duty Wipes, #05701, available from Kimberly-Clark Corporation).



CAUTION. *To prevent getting moisture inside the oscilloscope during external cleaning, use only enough liquid to dampen the cloth or applicator.*

If the display is very dirty, moisten the wipe with distilled water or a 75% isopropyl alcohol solution and gently rub the display surface. Avoid using excess force or you may damage the plastic display surface.

Appendix D: Menu Bar Commands

This appendix describes the commands and functions available from the menu bar. For more information about these commands, see the online help.

File Commands

Table D-1 lists the commands available from the File menu.

Table D- 1: File menu commands

Submenu	Command	Function
Reference Waveforms	Reference Setup	Opens the Reference Setup control window, used to create and control reference waveforms.
	Display On/Off	Opens the Waveform Display control window, used to turn the display of waveforms on and off.
	Position/Scale	Opens the Position/Scale control window, used to position the waveform and set the vertical scale.
	Label	Opens the Waveform Label control window, used to attach a label to the waveform.
	Save Wfm	Opens the Reference Setup control window, used to create and control reference waveforms.
	Recall Wfm	Opens the Reference Setup control window, used to create and control reference waveforms.
	Delete All Refs	Deletes all reference waveforms.
	Instrument Setup	Opens the Instrument Setup control window, used to save, recall, or delete saved instrument setups.
	Recall Default Setup	Recalls the factory default oscilloscope setup.
Run Application	(depends on installed applications)	Allows you to start an optional application.
	Page Setup	Opens the Page Setup dialog box, used to define the page before sending data to a printer.
	Print Preview	Shows you a preview of the page before you print.
	Print	Opens the Print dialog box, used to send data to your printer.
	Export Setup	Opens the Export Setup control window, used to set up and export images, waveforms, and measurements.

Table D-1: File menu commands (Cont.)

Submenu	Command	Function
Select for Export	Full Screen (bitmap) Graticule (bitmap) Waveform (data) Measurements (data)	Select an option to change the type of items exported without opening the Export Setup control window each time.
	Export	Opens the Export dialog box, used to export images, waveforms, or measurements to a file for analysis with other applications.
	1 <i>Recent Setup File 1</i>	Recalls (loads) the most recent setup file. Will not be present if you have not saved any setups.
	Minimize	Minimizes the oscilloscope application, displaying the Windows desktop.
	Shutdown	Shuts down the oscilloscope.

Edit Commands

Table D-2 lists the commands available from the Edit menu.

Table D-2: Edit menu commands

Submenu	Command	Function
	Undo Last Autoset	Undoes the last Autoset operation.
	Copy	Copies the full screen, graticule, waveform, or measurement to the clipboard for use with other applications.
Select for Copy	Full Screen (bitmap), Graticule (bitmap), Waveform (data), Measurement (data)	Select an option to change the type of items copied without opening the Copy Setup control window each time.
	Copy Setup	Opens the Copy Setup control window, used to set up and copy images, waveforms, and measurements.

Vertical Commands

Table D-3 lists the commands available from the Vertical menu.

Table D-3: Vertical menu commands

Submenu	Command	Function
	Vertical Setup	Opens the Vertical Setup control window, used to set the vertical parameters for live (channel) waveforms. The controls for each channel are independent. Use the tabs at the top of the control window to select the channel you want to change.
	Zoom Controls	Opens the Zoom control window, used to set the position and scale of zoomed waveforms.
	Display On/Off	Opens the Waveform Display control window, used to turn the display of waveforms on and off.
	Position/Scale	Opens the Position/Scale control window, used to position the waveform and set the vertical scale.
	Label	Opens the Waveform Label control window, used to attach a label to the waveform.
	Offset	Opens the Vertical Offset control window, used to set the vertical offset and scale of a waveform.
	Termination	Opens the Termination control window, used to select input termination for a channel.
	Invert	Opens the Channel Invert control window, used to invert a live channel waveform.
	Coupling	Opens the Coupling control window, used to select input coupling for a channel.
	Bandwidth	Opens the Bandwidth control window, used to set the bandwidth of a channel.
	Probe Cal	Opens the Probe Cal control window, used to check probe status and compensate the entire signal path from the probe tip to digitized signal.
	Deskew	Opens the Deskew control window, used to compensate for propagation delays of input channels. The deskew range is ± 75 ns.
	Attenuation	Opens the Attenuation control window, used to set the external attenuation or gain between the signal and the input channels.
	Zoom Setup	Opens the Zoom Setup control window, used to set up the horizontal and vertical zoom controls.
Zoom Graticule	50-50 Split 80-20 Split Full Screen	Directly access the options that allocate portions of the available display for the zoomed graticule.

Horizontal and Acquisition Commands

Table D-4 lists the commands available from the Horiz/Acq (Horizontal/Acquisition) menu.

Table D-4: Horiz/Acq menu commands

Submenu	Command	Function
	Horizontal/Acquisition Setup	Opens the Horizontal and Acquisition Setup window, used to set up the horizontal and acquisition parameters of waveforms. The horizontal and acquisition controls are common to all channels.
	Zoom Controls	Opens the Zoom control window, used to set the position and scale of zoomed waveforms.
	Autoset	Automatically sets up the front-panel controls based on the characteristics of the input signal and default selections.
	Fast Acquisitions	Toggles Fast Acquisitions mode on and off.
	Run/Stop	Opens the Run/Stop control window, used to start and stop acquisitions, control a single sequence of acquisitions, and display the acquisition status.
	Delay Mode On	Toggles horizontal delay mode on and off.
	Roll Mode Auto	Toggles roll mode on and off. When on, the oscilloscope automatically enters roll mode at slower horizontal scale settings.
	Equivalent Time Auto	Toggles equivalent time on and off. When on, the oscilloscope automatically uses equivalent time sampling when the sample rate is too fast to acquire enough samples using real-time sampling.
	Position/Scale	Opens the Horizontal Position/Display control window, used to toggle delay mode, position the waveform, and set the horizontal scale.
	Resolution	Opens the Resolution control window, used to set the record length and view the duration, sample rate, and resolution.
	Acquisition Mode	Opens the Acquisition Mode control window, used to select the acquisition mode.
	FastFrame Setup	Displays the FastFrame Setup window that you use to set up FastFrame acquisitions
	FastFrame Controls	Displays the FastFrame control window that you use to select the frame to view and the reference frame used by time stamps
	Zoom Setup	Opens the Zoom Setup control window, used to set up the horizontal and vertical zoom controls.
Zoom Graticule	50-50 Split 80-20 Split Full Screen	Directly access the options that allocate portions of the available display for the zoomed graticule.
Zoom Lock	All Live None	Directly set the zoom lock to focus the Zoom on the waveform(s) of interest.

Trigger Commands

Table D-5 lists the commands available from the Trig (Trigger) menu.

Table D-5: Trig menu commands

Submenu	Command	Function
	A Event (Main) Trigger Setup	Opens the Trigger Setup control window, used to set up the A Event triggers.
Quick Select	Edge, Glitch, Width, Runt, Window, Timeout, Transition, Setup/Hold, Logic Pattern, Logic State, Video	Opens the control window for each of these trigger types.
	Edge Setup	Opens the Trigger Setup control window for the Edge trigger type.
	Glitch Setup	Opens the Trigger Setup control window for the Glitch trigger type.
	Width Setup	Opens the Trigger Setup control window for the Width trigger type.
	Runt Setup	Opens the Trigger Setup control window for the Runt trigger type.
	Window Setup	Opens the Trigger Setup control window for the Window trigger type.
	Timeout Setup	Opens the Trigger Setup control window for the Timeout trigger type.
	Transition Setup	Opens the Trigger Setup control window for the Transition trigger type.
	Setup/Hold Setup	Opens the Trigger Setup control window for the Setup/Hold trigger type.
	Logic Pattern	Opens the Trigger Setup control window for the Pattern trigger type.
	Logic State	Opens the Trigger Setup control window for the State trigger type.
	Video Setup	Opens the Trigger Setup control window for the Video trigger type.
	A-B Trigger Sequence	Opens the Trigger Setup control window to set up A-B sequence triggering.
	B Event (Delayed) Trigger Setup	Opens the Trigger Setup control window to set up the selected the B trigger type.
	Holdoff	Opens the Holdoff control window, used to set trigger holdoff.
	Mode	Opens the Mode control window, used to select the trigger mode, force a trigger, and set the trigger level to 50%.
	Run/Stop	Opens the Run/Stop control window you can use to start and stop acquisitions, control a single sequence of acquisitions, and display the acquisition status.

Display Commands

Table D-6 lists the commands available from the Display menu.

Table D-6: Display menu commands

Submenu	Command	Function
	Display Setup	Opens the Display Setup control window, from which you can set up the display appearance, screen text, screen objects, and screen colors.
	Appearance	Opens the Appearance tab of the Display Setup control window, used to set the display style, display persistence, waveform intensity, display format, and waveform interpolation.
	Screen Text	Opens the Screen Text tab of the Display Setup control window where you can define text captions to add to the oscilloscope display.
	Objects	Opens the Objects tab of the Display Setup control window, used to change the appearance of objects on the display.
	Colors	Opens the Colors tab of the Display Setup control window, used to set the color of screen objects.
Display Style	Dots, Vectors, Intensified Samples	Directly access the waveform display style options.
Display Persistence	No Persistence, Infinite Persistence, Variable Persistence	Directly access the waveform display persistence options.
Display Format	Y-T, X-Y, X-Y-Z	Directly access the waveform display format options.
Display Palette	Normal, Monochrome Gray, Monochrome Green, Temperature Grading, Spectral Grading	Directly access the waveform display palette options.
Waveform Interpolation	Sin(x)/x, Linear	Choose from Sin(x)/x or Linear interpolation.
Graticule Style	Full, Grid, Cross-Hair, Frame, IRE, mV	Directly access the waveform display style options.
	LCD Save Enabled	Toggle the backlight timeout.
	Display Date & Time	Toggle the date and time display.

Cursors Commands

Table D-7 lists the commands available from the Cursors menu.

Table D-7: Cursors menu commands

Submenu	Command	Function
	Cursor Controls	Opens the Cursor Type Setup control window, used to select the type of cursors.
	Cursors On	Toggles display of cursors on and off.
Cursor Type	H-bars, V-bars, Paired, Split	Enables the selected cursor type.
Cursor Mode	Independent, Track	Sets the selected cursor tracking mode.
	Cursor Position	Opens the Cursor Position control window, used to position the cursors.
	Cursor Setup	Opens the Cursor Setup control window, used to set up and control cursors.

Measure Commands

Table D-8 lists the commands available from the Measure (Measurement) menu.

Table D-8: Measure menu commands

Submenu	Command	Function
	Measurement Setup	Opens the Measurement Setup control window, used to set up the oscilloscope for automatic measurements.
	Snapshot	Lets you see all of the automated measurements for a selected waveform at one time.
Amplitude	High Level, Low Level, Amplitude, Maximum, Minimum, Peak to Peak, Pos Overshoot, Neg Overshoot, Mean, RMS, Cycle Mean, Cycle RMS	Selects the individual automatic amplitude measurement directly without opening the Measurement Setup control window.
Time	Rise Time, Fall Time, Positive Width, Negative Width, Period, Frequency, Delay, Pos Duty Cycle, Neg Duty Cycle	Selects the individual automatic time measurement directly without opening the Measurement Setup control window.
More	Area, Cycle Area, Phase, Burst Width	Selects the individual automatic measurement directly without opening the Measurement Setup control window.

Table D-8: Measure menu commands (Cont.)

Submenu	Command	Function
Display Statistics	Value, Value, Mean, Value, Statistics	Opens the selected measurement statistics of current measurements.
	Reference Levels	Opens the Reference Levels control window, used to define reference levels for the measurements.
	Gating	Opens the Measurement Gating control window, used to limit the measurement area of the waveform to the region bounded by the vertical bar cursors or to the left and right edges of the Zoom window.
	Waveform Histograms (Optional)	Opens the Waveform Histogram setup window, used to set histograms on your waveforms. Only available if you have Option 2A, Advanced Analysis, installed.
	Reset Histograms (Optional)	Resets histogram counting. Only available if you have Option 2A, Advanced Analysis, installed.
Histogram Measurements (Optional)	Value Count, Hits in Box, Peak Hits, Median, Maximum, Minimum, Peak to Peak, Mean, Standard Deviation, Mean \pm 1 StdDev, Mean \pm 2 StdDev, Mean \pm 3 StdDev	Opens the selected measurement for the histogram. Only available if you have Option 2A, Advanced Analysis, installed.

Standard Math Commands

Table D-9 lists the commands available from the standard (default) Math menu.

Table D-9: Standard Math menu commands

Submenu	Command	Function
	Math Setup	Opens the Math Setup control window, used to define and create math waveforms.
	Display On/Off	Opens the Waveform Display control window, used to turn the display of waveforms on and off.
	Position/Scale	Opens the Position/Scale control window, used to position the waveform and set the vertical scale.
	Label	Opens the Waveform Label control window, used to attach a label to the waveform.
	Magnitude Spectrum	Creates a predefined magnitude spectral math waveform.

Advanced Math Commands (Optional)

Table D-9 lists the commands available from the Advanced Math menu. This version of the Math menu is present when you purchase Option 2A, Advanced Analysis.

Table D-10: Advanced Math menu commands

Submenu	Command	Function
	Math Setup	Opens the Math Setup control window, used to define and create math waveforms.
	Display On/Off	Opens the Waveform Display control window, used to turn the display of waveforms on and off.
	Position/Scale	Opens the Position/Scale control window, used to position the waveform and set the vertical scale.
	Label	Opens the Waveform Label control window, used to attach a label to the waveform.
	Ch1-Ch2	Creates a predefined math waveform.
	Ch3-Ch4	Creates a predefined math waveform.
	Ch1*Ch2	Creates a predefined math waveform.
	Ch3*Ch4	Creates a predefined math waveform.
	Spectral Setup	Opens the Spectral Math Setup control window, used to create spectral math waveforms.
	Magnitude Spectrum	Creates a predefined magnitude spectral math waveform.
	Phase Spectrum	Creates a predefined phase spectral math waveform.
	Spectral Controls	Opens the Spectral Math control window, used to control your spectral math waveform.
	Set Math Averages	Opens the Math Averaging control window, used to set up averaging in math waveforms.
	Equation Editor	Opens the Equation Editor control window, used to create advanced math waveforms.

Utilities Commands

Table D-11 lists the commands available from the Utilities menu.

Table D-11: Utilities menu commands

Menu	Command	Function
	Tek Secure Erase	Erases all waveforms and instrument setups.
	Set Time & Date	Opens the Set Time and Date control window, used to set the time and date on the oscilloscope.
	GPIB Configuration	Opens the GPIB Configuration control window, used to configure the oscilloscope for GPIB (General Purpose Interface Bus) applications.
	External Signals	Opens the External Signals control window, used to select the trigger signal to send to the AUX OUT BNC connector, or to toggle the oscilloscope clock reference source.
	Instrument Calibration	Opens Instrument Calibration control window to calibrate the oscilloscope.
	Instrument Diagnostics	Opens a window used to run oscilloscope diagnostics and view the diagnostic status and error log.
	Deassign Multipurpose Knobs	Deassigns the multipurpose knobs from their current function.
	User Preferences	Opens the User Preferences control window, used to enable prompts before the oscilloscope performs requested actions, set keypad trigger level defaults, and select whether horizontal scale or sample rate is held constant when you change record length.
	Display Recorder	Opens the Display Recorder, used to record actions while working with the display.
	Option Installation	Use Option Installation to enable upgrades you have purchased for your oscilloscope from Tektronix.

Help Commands

Table D-12 lists the commands available from the Help menu.

Table D-12: Help menu commands

Submenu	Command	Function
	Help on Window	Opens online help on the current window.
	Contents and Index	Opens the contents and index dialogs of the online help.
	Restore Help	Redisplays help window if minimized.
	Specifications	Opens the oscilloscope specifications.
	Technical Support	Describes how to obtain technical support.

Table D- 12: Help menu commands (Cont.)

Submenu	Command	Function
	Customer Feedback	Describes how to supply customer feedback.
	About Tek Scope	Shows the oscilloscope version number, serial number, instrument ID, copyright, installed options list, and option installation key.

Appendix E: Optimizing Measurement Accuracy

This oscilloscope can compensate itself and any attached probes, optimizing the internal signal path used to acquire the waveforms you measure. Compensation optimizes the capability of the oscilloscope to take accurate measurements based on the ambient temperature.

This appendix contains procedures that will help increase the accuracy of the measurements you take.

Compensating the Oscilloscope

Use this procedure to compensate the oscilloscope so that it can take accurate measurements based on the ambient temperature.

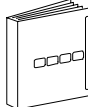
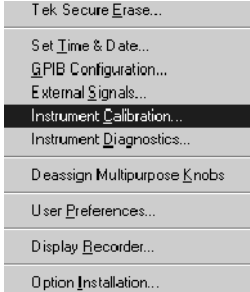
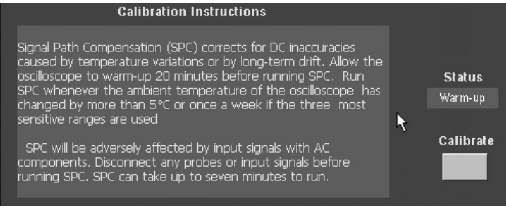
Overview	To compensate the oscilloscope	Control elements and resources
Prerequisites	<ol style="list-style-type: none"> The oscilloscope must be powered on. Allow a 20 minute warm up. Remove all input signals. 	 <p>See <i>Powering on the Oscilloscope</i> on page 1-8.</p>
Display the calibration instructions	<ol style="list-style-type: none"> From the menu bar, select the Utilities menu Instrument Calibration command. 	
Calibrate the oscilloscope	<ol style="list-style-type: none"> The Status control should indicate Pass. If the Status is Warm-up, wait until it changes. If it does not change to Pass, use the following steps to calibrate the oscilloscope. <p>Note: Signal Path Compensation is the only calibration function accessible to users.</p> Click Calibrate to start the calibration. Calibration may take several minutes. Calibration is complete after Running is no longer displayed in the Status readout. <p>The calibration Status should be Pass. If not, have the oscilloscope serviced by qualified service personnel.</p>	

Overview	To compensate the oscilloscope (Cont.)	Control elements and resources
For further assistance	5. Access the online help.	 <p data-bbox="992 506 1398 531">See page 3-209 to learn about using online help.</p>

Connecting Probes for Calibration

To compensate or calibrate probes you must connect them to the probe compensation terminals on the instrument, as shown below.

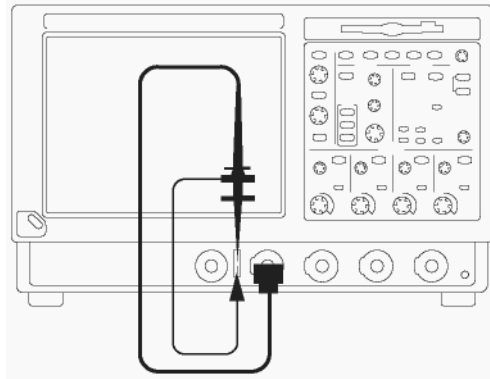



Connect the probe tip and the ground lead to the two probe compensation connectors on the fixture as shown. If using the probe hook-tip, ensure a proper connection by firmly twisting the tip onto the probe.

Calibrating Probes

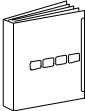



Use this procedure to optimize gain and offset accuracy at the probe tip for many types of probes.

Overview	To calibrate probes	Control elements and resources
<p>Prerequisites</p>	<p>1. The oscilloscope should be powered on and allowed to warm up for 20 minutes.</p> <p>Note: Probes with an attenuation factor of greater than 20X cannot be compensated. Probes with >2% gain errors or >50 mV offset errors cannot be compensated.</p>	 <p>See <i>Powering on the Oscilloscope</i> on page 1-8.</p>

Overview	To calibrate probes	Control elements and resources
<p>Optimize gain and offset accuracy</p>	<ol style="list-style-type: none"> 2. Connect the probe to the oscilloscope and the probe tip to the probe compensation terminals (see <i>Connecting Probes for Calibration</i> on page E-3). 3. If calibrating a passive probe, first perform the <i>Compensating Low Frequency Probes</i> procedure on page E-5. 4. Click the VERT toolbar button to open the Vertical Setup control window. 5. Click the Probe Cal button to open the Probe Calibration control window. 6. Select the oscilloscope channel to which the probe is attached. 7. Click Clear Probecal to erase any previous calibration data. 8. Click the Calibrate Probe button. 9. Check the Probe Status readout. <i>Initialized</i> indicates that the probe has not been calibrated on the selected channel. <i>Pass</i> indicates that the probe has been calibrated on the selected channel. <p>Note: Probes without a TEKPROBE interface cannot be calibrated.</p>	
<p>For further assistance</p>	<ol style="list-style-type: none"> 10. Access the oscilloscope online help. 	 <p>See page 3-209 to learn about using online help.</p>

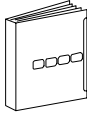
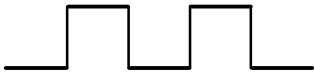
Compensating Low Frequency Probes

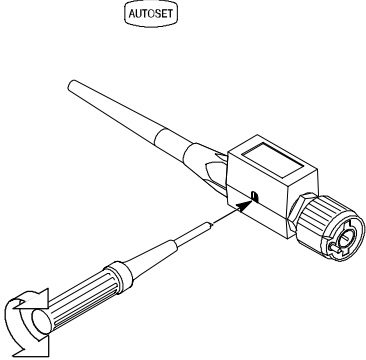

Use this procedure to compensate passive probes to ensure maximum distortion-free inputs to the oscilloscope.

Overview	To compensate passive probes	Control elements and resources
<p>Prerequisites</p>	<p>1. The oscilloscope must be powered on. Allow a 20 minute warm up.</p>	 <p>See <i>Powering on the Oscilloscope</i> on page 1-8.</p>
<p>Low frequency compensation</p>	<p>2. Connect the probe to oscilloscope Channel 1 and the probe tip to the probe compensation terminals (see <i>Connecting Probes for Calibration</i> on page E-3).</p> <p>3. Connect one probe to the fixture.</p> <p>4. Push the front-panel AUTOSET button.</p> <p>5. Adjust the probe until you see a square wave with a perfectly flat top on the display. See your probe manual for adjustment instructions.</p> <div style="display: flex; justify-content: space-around; align-items: flex-start;"> <div style="text-align: center;">  <p>Probe compensated correctly</p> </div> <div style="text-align: center;">  <p>Probe overcompensated</p> </div> <div style="text-align: center;">  <p>Probe undercompensated</p> </div> </div>	
<p>For further assistance</p>	<p>6. Access the oscilloscope online help.</p>	 <p>See page 3-209 to learn about using online help.</p>

Deskewing Channels

You can adjust a relative time delay for each channel. This lets you align the signals to compensate for signals that may come in from cables of differing lengths. The oscilloscope applies deskew values after it completes each acquisition; therefore, the deskew values do not affect logic triggering. Also, deskew has no affect on XY and XYZ display formats.

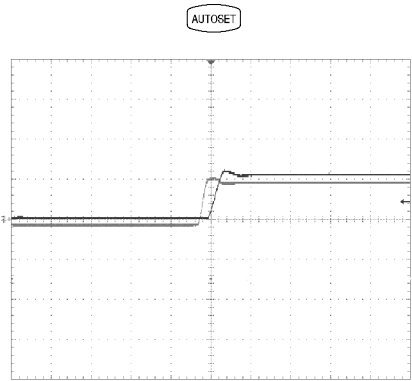
Overview	To deskew channels	Control elements and resources
<p>Prerequisites</p>	<p>1. The oscilloscope must be powered on. Allow a 20 minute warmup.</p>	<div data-bbox="1149 583 1240 699" data-label="Image"> </div> <p data-bbox="980 709 1398 741">See <i>Powering on the Oscilloscope</i> on page 1-8.</p>

Overview	To deskew channels	Control elements and resources
<p>Compensate probe timing (deskew)</p>	<ol style="list-style-type: none"> 2. Connect up to four probes to the oscilloscope and the probe tips to the probe compensation terminals (see <i>Connecting Probes for Calibration</i> on page E-3). 3. Turn on each channel that you want to deskew (the front-panel CH button will be lighted). 4. Push the front-panel AUTOSET button. 5. Adjust Vertical SCALE and POSITION for each channel so that the signals overlap and are centered on screen. 6. Adjust horizontal POSITION so that a triggered rising edge is at center screen. 7. Adjust horizontal SCALE so that the differences in the channel delays are clearly visible. 8. Adjust horizontal POSITION again so that the first rising edge is exactly at center screen. The fastest probe is connected to this channel. (The fastest probe is probably the one with the shortest cable or the highest bandwidth.) 9. From the toolbar, click VERT to open the Vertical Setup control window. 10. Click the Probe Deskew button to open the Deskew control window. 11. Select one of the slower channels. 12. Click Deskew Time and use the multipurpose knobs or pop-up keypad to adjust the deskew time for that channel so that its signal aligns with that of the fastest channel. (The deskew range is ± 75 ns.) 13. Repeat steps 11 and 12 for each additional channel that you want to deskew. 14. Remove the connections. 	 
<p>For further assistance</p>	<ol style="list-style-type: none"> 15. Access the oscilloscope online help. 	 <p>See page 3-209 to learn about using online help.</p>

Glossary

AC coupling

A type of signal transmission that blocks the DC component of a signal but uses the dynamic (AC) component. Useful for observing an AC signal that is normally riding on a DC signal.

Accuracy

The closeness of the indicated value to the true value.

Acquisition

The process of sampling signals from input channels, digitizing the samples into data points, and assembling the data points into a waveform record. The waveform record is stored in memory. The trigger marks time zero in that process.

Acquisition interval

The time duration of the waveform record divided by the record length. Except in equivalent time, the oscilloscope acquires one data point for every acquisition interval.

Aliasing

A false representation of a signal due to insufficient sampling of high frequencies or fast transitions. A condition that occurs when an oscilloscope digitizes at an effective sampling rate that is too slow to reproduce the input signal. The waveform displayed on the oscilloscope may have a lower frequency than the actual input signal.

Amplitude

The High waveform value less the Low waveform value.

AND

A logic (Boolean) function in which the output is true only when all the inputs are true. On the oscilloscope, that is a trigger logic pattern and state function.

Area

Measurement of the waveform area taken over the entire waveform or the gated region. Expressed in mixed amplitude and time units, such as volt-seconds. Area above ground is positive; area below ground is negative.

Attenuation

The degree the amplitude of a signal is reduced when it passes through an attenuating device such as a probe or attenuator. That is, the ratio of the input measure to the output measure. For example, a 10X probe will attenuate, or reduce, the input voltage of a signal by a factor of 10.

Automatic trigger mode

A trigger mode that causes the oscilloscope to automatically acquire if triggerable events are not detected within a specified time period.

Autoset

A function of the oscilloscope that automatically produces a stable waveform of usable size. Autoset sets up front-panel controls based on the characteristics of the active waveform. A successful autoset will set the volts/div, time/div, and trigger level to produce a coherent and stable waveform display.

Average acquisition mode

In this mode, the oscilloscope acquires and displays a waveform that is the averaged result of several acquisitions. Averaging reduces the apparent noise. The oscilloscope acquires data as in the sample mode and then averages it according to a specified number of averages.

Averaging

Displaying a trace that is the combined result of several acquisitions, thereby reducing apparent noise.

Bandwidth

The highest frequency signal the oscilloscope can acquire with no more than 3 dB ($\times .707$) attenuation of the original (reference) signal.

Burst width

A timing measurement of the duration of a burst.

Channel

One type of input used for signal acquisition. The oscilloscope has four channels.

Channel/probe deskew

A relative time delay for each channel. This lets you align signals to compensate for the fact that signals may come in from cables of differing length.

Channel Reference Indicator

The indicator on the left side of the display that points to the position around which the waveform contracts or expands when vertical scale is changed. This position is ground when offset is set to 0 V; otherwise, it is ground plus offset.

Control window

A group of related controls for a major oscilloscope function that the oscilloscope displays at the right of the screen.

Coupling

The association of two or more circuits or systems in such a way that power or information can be transferred from one to the other. You can couple the input signal to the trigger and vertical systems several different ways.

Cursors

Paired markers that you can use to make measurements between two waveform locations. The oscilloscope displays the values (expressed in volts or time) of the position of the active cursor and the distance between the two cursors.

Cycle area

A measurement of waveform area taken over one cycle. Expressed in volt-seconds. Area above ground is positive; area below ground is negative.

Cycle mean

An amplitude (voltage) measurement of the arithmetic mean over one cycle.

Cycle RMS

The true Root Mean Square voltage over one cycle.

DC coupling

A mode that passes both AC and DC signal components to the circuit. Available for both the trigger system and the vertical system.

Delay measurement

A measurement of the time between the middle reference crossings of two different waveforms.

Delay time

The time between the trigger event and the acquisition of post trigger data.

Digitizing

The process of converting a continuous analog signal such as a waveform to a set of discrete numbers representing the amplitude of the signal at specific points in time. Digitizing is composed of two steps: sampling and quantizing.

Display

The part of the oscilloscope that shows waveforms, measurements, control windows, status, and other parameters.

Fast Acquisition mode

A mode that increases the waveform capture rate to up to 200,000 waveforms per second. This very fast capture rate greatly increases the probability that runs, glitches, and other short term changes will accumulate in waveform memory. The oscilloscope then displays the waveform at the normal display rate using variable or infinite persistence. This display mode emulates the display of an analog oscilloscope.

Edge trigger

Triggering occurs when the oscilloscope detects the source passing through a specified voltage level in a specified direction (the trigger slope).

Envelope acquisition mode

A mode in which the oscilloscope acquires and displays a waveform that shows the variation extremes of several acquisitions.

Equivalent time sampling (ET)

A sampling mode in which the oscilloscope acquires signals over many repetitions of the event. These oscilloscopes use a type of equivalent time sampling called *random equivalent time sampling*, which uses an internal clock that runs asynchronously with respect to the input signal and the signal trigger. The oscilloscope takes samples continuously, independent of the trigger position, and displays them based on the time difference between the sample and the trigger. Although the samples are taken sequentially in time, they are random with respect to the trigger.

Fall time

A measurement of the time it takes for the trailing edge of a pulse to fall from a HighRef value (typically 90%) to a LowRef value (typically 10%) of its amplitude.

Frequency

A timing measurement that is the reciprocal of the period. Measured in Hertz (Hz) where 1 Hz = 1 cycle per second.

Gated measurements

A feature that lets you limit automated measurements to a specified portion of the waveform. You define the area of interest using the vertical cursors.

Glitch positive trigger

Triggering occurs if the oscilloscope detects positive spike widths less than the specified glitch time.

Glitch negative trigger

Triggering occurs if the oscilloscope detects negative spike widths less than the specified glitch time.

Glitch either trigger

Triggering occurs if the oscilloscope detects either positive or negative spike widths less than the specified glitch time.

GPIO (General Purpose Interface Bus)

An interconnection bus and protocol that allows you to connect multiple instruments in a network under the control of a controller. Also known as IEEE 488 bus. It transfers data with eight parallel data lines, five control lines, and three handshake lines.

Graticule

A grid on the display screen that creates the horizontal and vertical axes. You can use it to visually measure waveform parameters.

Ground (GND) coupling

Coupling option that disconnects the input signal from the vertical system.

Hard copy

An electronic copy of the display in a format useable by a printer or plotter.

Hi Res acquisition mode

An acquisition mode in which the oscilloscope averages all samples taken during an acquisition interval to create a record point. That average results in a higher-resolution, lower-bandwidth waveform. That mode only works with real-time, non-interpolated sampling.

High

The value used as 100% in automated measurements (whenever High Ref, Mid Ref, and Low Ref values are needed as in fall time and rise time measurements). May be calculated using either the min/max or the histogram method. With the min/max method (most useful for general waveforms), it is the maximum value found. With the histogram method (most useful for pulses), it refers to the most common value found above the mid point.

Holdoff, trigger

A specified amount of time after a trigger signal that elapses before the trigger circuit will accept another trigger signal. Trigger holdoff helps ensure a stable display.

Horizontal bar cursors

The two horizontal bars that you position to measure the voltage parameters of a waveform. The oscilloscope displays the value of the active (moveable) cursor with respect to ground and the voltage value between the bars.

Horizontal reference point

The point about which the trace is expanded or contracted when horizontal size adjustments are made. The horizontal reference point remains anchored as the rest of the trace grows or shrinks around it.

Initialize

Setting the oscilloscope to a completely known, default condition.

Intensity

Display brightness.

Interleaving

A method by which these oscilloscopes attain higher digitizing speeds. The oscilloscope applies the digitizing resources of unused channels (that is, channels that are turned off) to sample those that are in use (turned on). Table 3-3 on page 3-35 lists acquisition rates vs. number of channels that are on.

Interpolation

The way the oscilloscope calculates values for record points when the oscilloscope cannot acquire all the points for a complete record with a single trigger event. That condition occurs when the oscilloscope is limited to real time sampling and the time base is set to a value that exceeds the effective sample rate of the oscilloscope. The oscilloscope has two interpolation options: *linear* or *sin(x)/x interpolation*.

Linear interpolation calculates record points in a straight-line fit between the actual values acquired. Sin(x)/x computes record points in a curve fit between the actual values acquired. It assumes all the interpolated points fall in their appropriate point in time on that curve.

Live waveforms

Waveforms that can update as the acquisition system updates them. Channel waveforms are live waveforms; reference waveforms are not. Math waveforms are live if they contain live waveforms in their expressions: Ch1 + Ref1 defines a live math waveform; Ref1 + Ref2 does not.

Logic state trigger

The oscilloscope checks for defined combinatorial logic conditions on channels 1, 2, and 3 on a transition of channel 4 that meets the set slope and threshold conditions. If the conditions of channels 1, 2, and 3 are met then the oscilloscope triggers.

Logic pattern trigger

The oscilloscope triggers depending on the combinatorial logic condition of channels 1, 2, 3, and 4. Allowable conditions are AND, OR, NAND, and NOR.

Low

The value used as 0% in automated measurements (whenever High Ref, Mid Ref, and Low Ref values are needed as in fall time and rise time measurements). May be calculated using either the min/max or the histogram method. With the min/max method (most useful for general waveforms), it is the minimum value found. With the histogram method (most useful for pulses), it refers to the most common value found below the mid point.

Maximum

Amplitude (voltage) measurement of the maximum amplitude. Typically the most positive peak voltage.

Mean

Amplitude (voltage) measurement of the arithmetic mean over the entire waveform.

Measurement

An automated numeric readout that the oscilloscope provides directly from the displayed trace in real time, without operator intervention.

Measurement statistics

The accumulation of a history of individual measurement readouts, showing the mean and standard deviation of a selected number of samples.

Measurement tracking

The process of automatically adjusting the measurement parameters to reflect changes in the trace.

Minimum

Amplitude (voltage) measurement of the minimum amplitude. Typically the most negative peak voltage.

Multipurpose knobs

Front-panel knobs you can use to change the value of the assigned parameter.

NAND

A logic (Boolean) function in which the output of the AND function is complemented (true becomes false, and false becomes true). On the oscilloscope, this is a trigger logic pattern and state function.

Negative duty cycle

A timing measurement representing the ratio of the negative pulse width to the signal period, expressed as a percentage.

Negative overshoot measurement

Amplitude (voltage) measurement.

$$\text{NegativeOvershoot} = \frac{\text{Low} - \text{Min}}{\text{Amplitude}} \times 100\%$$

Negative width

A timing measurement of the distance (time) between two amplitude points — falling-edge *MidRef* (default 50%) and rising-edge *MidRef* (default 50%) — on a negative pulse.

Normal trigger mode

A mode in which the oscilloscope does not acquire a waveform record unless a valid trigger event occurs. It waits for a valid trigger event before acquiring waveform data.

NOR

A logic (Boolean) function in which the output of the OR function is complemented (true becomes false, and false becomes true). On the oscilloscope, this is a trigger logic pattern and state function.

OR

A logic (Boolean) function in which the output is true if any of the inputs are true. Otherwise the output is false. On the oscilloscope, this is a trigger logic pattern and state function.

Oscilloscope

An instrument for making a graph of two factors. These are typically voltage versus time.

Peak Detect acquisition mode

A mode in which the oscilloscope saves the minimum and maximum samples over two adjacent acquisition intervals. For many glitch-free signals, that mode is indistinguishable from the sample mode. (Peak detect mode works with real-time, noninterpolation sampling only.)

Peak-to-Peak

Amplitude (voltage) measurement of the absolute difference between the maximum and minimum amplitude.

Period

A timing measurement of the time covered by one complete signal cycle. It is the reciprocal of frequency and is measured in seconds.

Persistence

The amount of time a data point remains displayed. There are three persistence modes available in the oscilloscope: Variable, Infinite, and Off.

Phase

A timing measurement between two waveforms of the amount one leads or lags the other in time. Phase is expressed in degrees, where one complete cycle comprises 360° of one of the waveforms. Waveforms measured should be of the same frequency or one waveform should be a harmonic of the other.

Pixel

A visible point on the display. The oscilloscope display is 640 pixels wide by 480 pixels high.

Positive duty cycle

A timing measurement of the ratio of the positive pulse width to the signal period, expressed as a percentage.

Positive overshoot

Amplitude (voltage) measurement.

$$PositiveOvershoot = \frac{Max - High}{Amplitude} \times 100\%$$

Positive width

A timing measurement of the distance (time) between two amplitude points — rising-edge *MidRef* (default 50%) and falling-edge *MidRef* (default 50%) — on a positive pulse.

Posttrigger

The specified portion of the waveform record that contains data acquired after the trigger event.

Pretrigger

The specified portion of the waveform record that contains data acquired before the trigger event.

Probe

An oscilloscope input device.

Probe compensation

Adjustment that improves low-frequency response of a probe.

Pulse trigger

A trigger mode in which triggering occurs if the oscilloscope finds a pulse of the specified polarity with a width between, or optionally outside, the user-specified lower and upper time limits.

Real-time sampling

A sampling mode where the oscilloscope samples fast enough to completely fill a waveform record from a single trigger event. Use real-time sampling to capture single-shot or transient events.

Record length

The specified number of samples in a waveform.

Reference memory

Memory in a oscilloscope used to store waveforms or settings. You can use that waveform data later for processing. The oscilloscope saves the data even when the oscilloscope is turned off or unplugged.

Reference waveforms

Waveforms that are static, not live (see live waveforms). Reference waveforms are channel or math waveforms that you save to references. Once saved, they do not update.

Rise time

The time it takes for a leading edge of a pulse to rise from a *LowRef* value (typically 10%) to a *HighRef* value (typically 90%) of its amplitude.

RMS

Amplitude (voltage) measurement of the true Root Mean Square voltage.

Runt trigger

A mode in which the oscilloscope triggers on a runt. A runt is a pulse that crosses one threshold but fails to cross a second threshold before recrossing the first. The crossings detected can be positive, negative, or either.

Sample acquisition mode

The oscilloscope creates a record point by saving the first sample during each acquisition interval. That is the default mode of the acquisition.

Sample interval

The time interval between successive samples in a time base. For real-time digitizers, the sample interval is the reciprocal of the sample rate. For equivalent-time digitizers, the time interval between successive samples represents equivalent time, not real time.

Sampling

The process of capturing an analog input, such as a voltage, at a discrete point in time and holding it constant so that it can be quantized. Two general methods of sampling are: *real-time sampling* and *equivalent-time sampling*.

Screen text

Lines displayed on screen that you use to indicate measurement reference levels and points that an automatic measurement is using to derive the measurement value.

Setup/Hold trigger

A mode in which the oscilloscope triggers when a data source changes state within the setup or hold time relative to a clock source. Positive setup times precede the clock edge; positive hold times follow the clock edge. The clock edge may be the rising or falling edge.

Slope

The direction at a point on a waveform. You can calculate the direction by computing the sign of the ratio of change in the vertical quantity (Y) to the change in the horizontal quantity. The two values are rising and falling.

Statistical measurement

An automated measurement that is derived from color-graded waveform data and is based on histograms computed at the crossing levels. A statistical measurement can be selected only in color-graded display mode.

Tek Secure

This feature erases all waveform and setup memory locations (setup memories are replaced with the factory setup). Then it checks each location to verify erasure. This feature finds use where this oscilloscope is used to gather security sensitive data, such as is done for research or development projects.

Time base

The set of parameters that let you define the time and horizontal axis attributes of a waveform record. The time base determines when and how long to acquire record points.

Timeout trigger

A trigger mode in which triggering occurs if the oscilloscope does not find a pulse of the specified polarity and level within the specified time period.

Trace

The visible representation of an input signal or combination of signals. Identical to waveform.

Trigger

An event that marks time zero in the waveform record. It results in acquisition and display of the waveform.

Trigger level

The vertical level the trigger signal must cross to generate a trigger (on edge trigger mode).

Vertical bar cursors

The two vertical bars that you position to measure the time parameter of a waveform record. The oscilloscope displays the value of the active (moveable) cursor with respect to the trigger and the time value between the bars.

Waveform

The shape or form (visible representation) of a signal.

Waveform interval

The time interval between record points as displayed.

XY format

A display format that compares the voltage level of two waveform records point by point. It is useful for studying phase relationships between two waveforms.

XYZ format

A display format that compares the voltage level of two waveform records point by point as in XY format. The displayed waveform intensity is modulated by the CH 3 (Z) waveform record.

YT format

The conventional oscilloscope display format. It shows the voltage of a waveform record (on the vertical axis) as it varies over time (on the horizontal axis).

Index

Numbers

50-50 Split command, D-3, D-4

80-20 Split command, D-3, D-4

A

A Event (Main) Trigger Setup, D-5

A Trigger, Level presets, 3-60

A Trigger control window

A Only, 3-95

A->B Seq tab, 3-95

Autoset buttons, 3-89

Clock Edge, 3-84, 3-85

Clock Source, 3-84

Custom video format, 3-89

Data Level, 3-85

Data Source, 3-84

Delay time, 3-95

Glitch, 3-68

Graticule, 3-90

Holdoff, 3-90

Input Threshold, 3-79, 3-82

Level, 3-73, 3-77, 3-90

Lower Level, 3-72, 3-87

Lower Limit, 3-73, 3-76

Pattern, 3-79

Pattern Type, 3-79, 3-83

Polarity, 3-68, 3-71, 3-73, 3-75, 3-90

Pulse, 3-73

Runt, 3-70

Setup/Hold, 3-84

slew rate, 3-75

Source, 3-68, 3-70, 3-73, 3-75, 3-77, 3-87, 3-89

Upper Level, 3-72, 3-76, 3-87

State, 3-82

Timeout, 3-77

Timer, 3-77

Transition, 3-75

Trigger Inside Violation, 3-85

Trigger On, 3-90

Trigger When, 3-78, 3-88

Trigger When Pattern, 3-80, 3-83

Trigger When Runt, 3-72

Trigger When Time, 3-81

Upper Limit, 3-73

Video, 3-89

Width, 3-68, 3-73

Window, 3-87

A->B Seq tab, 3-96

A Then B, 3-95, 3-96

B trigger level, 3-96

Trig Event, 3-96

A->B Trigger Sequence, D-5

Absolute Reference, 3-117

AC coupling, 3-6, 3-9, 3-56, Glossary-1

AC line voltage, trigger input, 3-50, 3-55

Accessing acquisition modes, 3-25

Accessing Online Help, 3-209

Accessories, 1-31

connecting, 1-7

monitors, 1-7

optional, 1-34

printers, 1-7

probes, 1-4

rackmount kit, 1-8

software, 1-11

standard, 1-33

Accuracy, Glossary-1

Acquiring Waveforms, 3-3

Acquisition, Glossary-1

input channels and digitizers, 3-30

interval, Glossary-1

Modes, Envelope, 3-43

preview, 3-101

process overview, 2-10

record, 3-31

sampling, 3-30

Acquisition Modes, 3-21

Acquisition Controls

Acquisition Control Background, 3-29

Acquisition Hardware, 3-30

aliasing illustrated, 3-24

Average, 3-22

Envelope, 3-21

Equivalent Time Sampling, illustrated, 3-33

Equivalent-time Sampling, 3-33

Global Controls, 3-22

Hi Res, 3-21

horizontal position, 3-31

incompatible acquisition modes, 3-24

Interleaving, 3-35

Interpolation, 3-34

Linear interpolation, 3-34

methods to check and eliminate aliasing, 3-24

Peak Detect, 3-21

real-time sampling, 3-32

record length, 3-31

- repetitive signal, 3-26
 - roll mode, 3-22
 - RUN/STOP button, 3-22, 3-26
 - Sample mode, 3-21
 - sample interval, 3-31
 - Sampling and acquisition mode, 3-33
 - Sampling Modes, 3-31
 - Sampling Process, 3-30
 - Setting Acquisition Modes, 3-25
 - Sin(x)/x interpolation, 3-34
 - SINGLE button, 3-22, 3-26
 - Start and Stopping Acquisition, 3-26
 - time sampling, 3-26
 - intensity, 3-40
 - trigger point, 3-31
 - untriggered roll mode, 3-22
 - untriggered roll mode with single sequence, 3-23
 - Using Fast Acquisitions Mode, 3-35
 - Using FastFrame, 3-42
 - Using Roll Mode, 3-28
 - Waveform Record, 3-31
 - Acquisition Features, A-2
 - Acquisition Mode command, D-4
 - acquisition mode
 - and math waveforms, 3-139
 - spectral math, 3-172
 - Acquisition Mode control window, D-4
 - Acquisition setup, D-4
 - adding comments to setups, 3-183
 - Address, Tektronix, xv
 - Adjusting Display Contrast, 1-17
 - adjusting the time base, 3-102
 - Advanced Analysis option, 3-145
 - ADVANCED button, 3-54, 3-59
 - Advanced Triggering, 3-62
 - aliasing, 3-23
 - defined, Glossary-1
 - eliminating, 3-24
 - illustrated, 3-24
 - recognizing, 3-172
 - ambient temperature, A-1
 - Amplitude, B-1, D-7, Glossary-1
 - Amplitude command, D-7
 - AND, Glossary-1
 - Appearance command, D-6
 - application, using an exported waveform in, 3-200
 - applications, 1-11
 - Area, B-1, D-7, Glossary-1
 - ARM status light, 3-57
 - Attenuation, Glossary-1
 - Attenuation command, D-3
 - Attenuation control window, D-3
 - AUTO trigger mode, 3-56
 - Auto-increment file name, 3-184, 3-186, 3-191, 3-199
 - AutoBright, 3-40, 3-108
 - automatic measurements, 3-115
 - sources
 - channel waveforms, 3-116
 - math waveforms, 3-116
 - reference waveforms, 3-116
 - Automatic trigger mode, 3-51, 3-56, Glossary-2
 - illustrated, 3-50
 - AUTOSET button, 3-5, 3-12
 - Autoset, 3-5, 3-14, D-4, Glossary-2
 - errors, 3-14
 - how to use, 3-12
 - prompt before, 3-13
 - undoing, 3-12
 - Autoset Undo, 3-12
 - Autosetting the Oscilloscope, 3-12
 - AUX IN, 3-50, 3-55
 - AUX Out Configuration, D-10
 - Auxiliary trigger, 3-50
 - Average, 3-43
 - Average mode, 3-22
 - Average mode, Glossary-2
 - averaged spectral waveform, creating, 3-177
 - Averaging, Glossary-2
 - spectral math, 3-172
 - Avg() function, 3-147
- ## B
- B Event (Delayed) Trigger Setup, D-5
 - B Event tab, Source, 3-96
 - B trigger
 - B Trig Level, 3-96
 - Slope, 3-96
 - backing up user files, 1-10
 - Backlight timeout, 3-108
 - Bandwidth, Glossary-2
 - Bandwidth command, D-3
 - Bandwidth control window, D-3
 - banner printing, 3-205
 - Bitmap file format, 3-196
 - Blackman-Harris window, 3-160, 3-162, 3-167
 - Burst Width, B-1, D-7
- ## C
- Calibrating Probes, E-3
 - calibrating the oscilloscope, E-1
 - CD-ROMs, 1-5
 - Operating System Restoration, 1-2

- optional applications, 1-11
- Performance Verification Procedures, 1-3
- Product Software, 1-10
- Product Software, 1-3
- center, defined, 3-155
- Certifications and compliances, A-21
- Ch1 - Ch2, D-9
- Ch1 * Ch2, D-9
- Ch3 - Ch4, D-9
- Ch3 * Ch4, D-9
- channel
 - defined, Glossary-2
 - deskew, E-6
- Channel configuration, 3-30
- Channel input and vertical specifications, A-5
- channel
 - channel invert, 3-9
 - shared horizontal window, 3-20
 - shared parameters, illustrated, 3-20
- Channel Invert control window, D-3
- Channel reference indicator, Glossary-2
- Channel-probe deskew, Glossary-2
- Channels, digitizer configuration, 3-30
- cleaning
 - exterior, C-1
 - flat panel display, C-1
- clearing all references and setups, 3-194
- clearing the Measurements list, 3-120
- clipping, 3-7, 3-15
 - derivative math waveforms, 3-142
 - how to avoid, 3-142, 3-143
 - integral math waveforms, 3-143
- clock signal, as a logic state input, 3-82
- color
 - math waveform, 3-108
 - palette, 3-107
 - reference waveform, 3-107
- Color Palette, 3-107
 - See also* Display Palette
- Colors command, D-6
- communication, 3-208
 - remote, 3-207
- compensating probe timing, E-7
- Connecting and Conditioning Your Signals, 3-5
- connecting peripherals, 1-6
- connecting to a network, 1-12
- connectivity tools, 2-2
- connectors
 - front panel, 2-3
 - rear panel, 2-7
 - side panel, 2-7
- Contacting Tektronix, xv
- Contents and Index, D-10
- Control window, Glossary-2
- Convenience Features, A-3
- Copy command, D-2
- Copy Setup, D-2
- Copy Setup control window, D-2
- copying waveforms, 3-196, 3-202
- Coupling command, D-3
- coupling, 3-6, 3-9
 - AC, 3-56
 - DC, 3-56
 - defined, Glossary-2
 - ground, Glossary-4
 - HF REJ, 3-56
 - LF REJ, 3-56
 - NOISE REJECT, 3-56
 - trigger, 3-52
- Coupling control window, D-3
- COUPLING controls, 3-54, 3-56
- Creating a Math Waveform, 3-144, 3-145
- creating an emergency startup disk, 1-9
- Creating and Using Math Waveforms, 3-135
- creating math waveforms, methods, 3-137
- Cross Hair graticule style, 3-106
- Cross-Hair graticule command, D-6
- Cursor Controls command, D-7
- Cursor Position command, D-7
- cursors, 3-124
 - and gating, 3-123
 - display limitations, 3-125
 - measurements, 3-124
 - position, 3-129
 - positions, changing, 3-127
 - sources, 3-128
 - Track Mode, 3-129
 - tracking, 3-125, 3-129
 - types, 3-125, 3-128
 - units, 3-126
 - using, 3-125
- cursor, defined, Glossary-3
- Cursor control window, 3-150
- cursor measurements, and math waveforms, 3-141
- Cursors menu
 - command summary, D-7
 - Cursor Controls, D-7
 - Cursor Mode, D-7
 - Cursor Position, D-7
 - Cursor Setup, D-7
 - Cursor Type, D-7
 - Cursors On, D-7
 - H-bars, D-7
 - Independent, D-7
 - Paired, D-7
 - Split, D-7

- Track, D-7
- V-bars, D-7
- Cursor Mode, D-7
- Cursor Position control window, D-7
- cursor readout, errors, 3-125
- Cursor Setup command, D-7
- Cursor Setup control window, D-7
- Cursor Type, D-7
- Cursor Type Setup control window, 3-128, 3-129, D-7
- cursor types
 - horizontal, 3-124
 - paired, 3-124
 - split, 3-124
 - vertical, 3-124
- cursors
 - with derivative waveforms, 3-150
 - with FFT waveforms, 3-173, 3-182
- CURSORS button, 3-128
- Cursors On command, D-7
- Cursor Setup control window, 3-124, 3-125, 3-127
- Customer Feedback, D-11
- customizing the display, 3-106
- Cycle Area, B-1, D-7, Glossary-3
- Cycle Mean, B-1, D-7, Glossary-3
- Cycle RMS, B-1, D-7, Glossary-3

D

- data, controlling input and output, 3-183
- Data Input/Output, 3-183
 - Bitmap file format, 3-196
 - clearing reference waveforms, 3-194
 - Copying Waveform Data, 3-202
 - copying waveforms, 3-196
 - deleting a reference waveform, 3-194
 - deleting a reference waveform file, 3-195
 - displaying a reference waveform, 3-193
 - Exporting a Waveform, 3-197
 - Exporting and Copying Waveforms, 3-196
 - exporting data to a file, 3-199
 - file formats, 3-196
 - Numeric, 3-196
 - importing waveform data, 3-200
 - Instrument Setup control window, 3-185, 3-187
 - JPEG file format, 3-196
 - label a waveform, 3-190
 - MathCad, file format, 3-196
 - MATLAB file format, 3-196
 - naming a setup, 3-186
 - Previewing the Page, 3-205
 - Print preview dialog box, illustrated, 3-206
 - Printing Banners, 3-206

- Printing from the Front Panel, 3-205
- Printing from the Menu Bar, 3-205
- Printing Waveforms, 3-205
- Recall Setup From a File, 3-188
- Recalling a Setup, 3-187
- Recalling a Waveform, 3-192
- Reference Setup control window, 3-190, 3-192, 3-194
- Remote Communication, 3-207
- Saving a Setup, 3-185
 - saving a setup to a file, 3-186
- Saving a Waveform, 3-190
- Saving and Recalling a Setup, 3-183
- Saving and Recalling Waveforms, 3-189
- selecting a format for copy, 3-202
- selecting a format for export, 3-197
- selecting a setup for copy, 3-202
- selecting a setup for export, 3-197
- selecting a waveform to save, 3-190
- setting export image options, 3-198
- setting image copy options, 3-203
- setting measurement copy options, 3-204
- setting measurement export options, 3-199
- Setting up the Page, 3-205
 - setting waveform copy options, 3-203
 - setting waveform export options, 3-198
- Spreadsheet file format, 3-196
- Text file format, 3-196
- Using an Exported Waveform, 3-200
- Using Auto-Increment Filename, 3-184
- Using Print Screen, 3-207
- Using the Date/Time Stamp, 3-207
- Data storage specifications, A-18
- Date and Time, 3-109
- Date/Time, on hard copies, 3-207
- DC coupling, 3-6, 3-9, 3-56, Glossary-3
- DC offset, with math waveforms, 3-143
- Deassign Multipurpose Knobs, D-10
- DEFAULT SETUP button, 3-5, 3-13
- Default trigger holdoff, 3-59
- Define/Edit Expression Editor, 3-158
- Defining A Spectral Math Waveform, 3-175
- Defining and displaying channel waveforms, 3-101
- Defining and displaying math waveforms, 3-101
- Defining and displaying reference waveforms, 3-101
- degrees, using as phase units, 3-179
- Delay, D-7
- DELAY button, 3-53
- Delay measurement, Glossary-3
- Delay Mode On command, D-4
- Delay time, Glossary-3

- Delayed trigger, 3-53
 - setting up, 3-95
- Delete All Refs, D-1
- Delete Reference Waveform dialog box, 3-195
- deleting waveform files, 3-194
- derivative math waveform, 3-141
 - applications, 3-140
 - procedure for measuring, 3-150
 - record length of, 3-141
- Description
 - key features, 1-1
 - product, 1-1
- deskew
 - channels, E-6
 - defined, Glossary-2
- Deskew command, D-3
- Deskew control window, D-3, E-7
- diagnostics, D-10
- Digitizing, Glossary-3
- digitizing process, defined, 3-30
- Disabling roll mode, 3-29
- Disp toolbar button, 3-106, 3-107, 3-108, 3-109
- display
 - customizing, 3-106
 - defined, 3-100
 - elements, 3-100
 - settings, 3-106
 - defined, Glossary-3
- Display Format, 3-108
- displaying math waveforms, 3-148
- Display Date & Time command, D-6
- Display Features, A-3
- Display Format, D-6
- Display menu
 - XY, 3-41
 - XYZ, 3-41
 - YT, 3-41
- Display menu
 - Appearance, 3-108
 - Colors, 3-107, 3-108
 - Display Date & Time, 3-109
 - Display Format, 3-108
 - Display Palette, 3-107
 - Display Persistence, 3-106
 - Display Style, 3-107
 - Graticule Style, 3-106
 - LCD Save Enabled, 3-108
 - Objects, 3-108, 3-109
 - Screen Text, 3-107
 - Waveform Interpolation, 3-108
- Display On/Off command, D-1, D-3, D-8, D-9
- Display Palette, D-6
- Display Persistence, 3-106, D-6
- Display Recorder, D-10
- Display Setup command, D-6
- Display Setup control window, D-6
- Display Setup control window
 - Appearance tab, 3-106, 3-107, 3-108
 - Colors tab, 3-107, 3-108
 - Objects tab, 3-106, 3-108, 3-109
 - Screen Text tab, 3-107
- Display specifications, A-16
- Display Statistics, D-8
- Display Style, 3-107
 - command, D-6
- Displaying and Measuring Math Waveforms, 3-148
- displaying calibration instructions, E-1
- Displaying Waveforms, 3-99
 - Acquisition Preview, 3-101
 - adjusting the horizontal reference, 3-105
 - backlight timeout, 3-108
 - Checking the Zoom Scale and Position, 3-113
 - color palette, 3-107
 - customizable display elements, 3-106
 - Customizing the Display, 3-106
 - date and time, 3-109
 - Defining and displaying waveforms, 3-101
 - Display and Acquisition Controls, 3-102
 - display elements, 3-100
 - display format, 3-108
 - Display Methods, 3-101
 - Display Operations, 3-102
 - display persistence, 3-106
 - display settings, 3-106
 - display style, 3-107
 - Displaying Waveforms in the Main Graticule, 3-104
 - focusing Zoom on waveform of interest, 3-112
 - graticule style, 3-106
 - graticules, 3-102
 - horizontal position, 3-103
 - horizontal reference point, 3-103
 - intensity, 3-108
 - interpolation, 3-108, 3-109
 - LCD Backlight, 3-108
 - linear interpolation, 3-109
 - math colors, 3-108
 - operations on the time base, 3-102
 - reference colors, 3-107
 - resetting Zoom, 3-113
 - screen saver, 3-108
 - screen text, 3-107
 - selecting Zoom, 3-111
 - setting up Zoom options, 3-112
 - setting horizontal display parameters, 3-104
 - setting vertical display parameters, 3-104
 - Sin(x)/x interpolation, 3-109

- trigger level marker, 3-108
- Using Display Controls, 3-106
- Using the Waveform Display, 3-100
- Using the Zoom Feature, 3-110
- using Zoom with waveforms, 3-110
- Waveform Display, 3-101
- waveform intensity, 3-108
- waveform interpolation, 3-108
- XY, 3-108
- XYZ, 3-108
- YT, 3-108
- Zoom Reset, 3-113

Documentation map, 2-2

dots, displaying waveform record points as, 3-107

DPO, Glossary-3

dual display, setup, 1-13

Dual Waveform Math

- how to use, 3-144
- using, 3-140

duration, 3-152

Duty cycle, Glossary-7, Glossary-8

E

ECL, 3-60, 3-68, 3-76, 3-77, 3-85

Edge Setup, D-5

Edge trigger, 3-51

- defined, Glossary-3

Edit menu

- command summary, D-2
- Copy, D-2
- Copy Setup, D-2
- Full Screen, D-2
- Graticule, D-2
- Measurement, D-2
- Select for Copy, D-2
- Undo Last Autoset, 3-13, D-2
- Waveform, D-2

Enabling roll mode, 3-28

Enabling single sequence roll mode, 3-29

entering a math expression, 3-144

Envelope, 3-43

Envelope acquisition mode, 3-43

Envelope mode, 3-21

- defined, Glossary-3

environment requirements, 1-6

Environmental specifications, A-20

Equation Editor, 3-145, D-9

- syntax for math expressions, 3-140

Equation Editor control window, 3-146, D-9

Equivalent Time Auto, 3-33, D-4

equivalent time sampling, 3-26, 3-33

- random, defined, Glossary-4
- random , 3-34

Equivalent-time sampling, 3-43

erasing all references and setups, 3-194

Error log, D-10

exiting the application, 1-12

Export command, D-2

export

- data formats, 3-197
- file formats, 3-196

Export dialog box, D-2

Export Setup, D-1

Export Setup control window, 3-197, D-1

exporting waveforms, 3-196, 3-197

Extended diagnostics, 1-30

Exterior Cleaning, oscilloscope, C-1

external monitor. *See* Dual display

External Signals control window, D-10

F

F1 key, using for online help, 3-210

Factory default settings, 3-13

Fall Time, B-1, D-7

Fall time, Glossary-4

Fast Acquisition, 3-43

Fast Acquisition mode, and single-sequence triggering, 3-61

Fast Acquisitions, 3-35, D-4

- adjusting the intensity, 3-40
- and acquisition preview, 3-101
- and math waveforms, 3-138
- copying data, 3-203
- exporting data, 3-198
- modes incompatible with, 3-35
- Normal DSO and Fast Acquisitions Displays, 3-36
- Selecting the Color Palette, 3-40
- Setting Display Format, 3-41
- Setting the display appearance, 3-39
- Setting the display readout options, 3-39
- Turning Fast Acquisitions On and Off, 3-39
- Using Fast Acquisitions, 3-36
- Using Fast Acquisitions Mode, 3-35
- Vs. Normal DSO mode, illustrated, 3-38
- Waveform Capture Rate, 3-36

Fast Fourier Transforms, description. *See* FFT

FastFrame, 3-42, 3-116, 3-138

- Controls, D-4
- FastFrame Time Stamp, illustrated, 3-48
- interactions, 3-43

RUN/STOP, 3-43
 Select the FastFrame and Time Stamps Selection Controls, 3-47
 Select the Frame to View, 3-45
 Select the Reference Frame, 3-46
 Set Frame Count, 3-45
 Set Frame Length, 3-44
 Setup, D-4
 Time Stamping Frames, 3-45
 To Lock the Reference Position Frames, 3-48
 To Set FastFrame Mode, 3-44
 To view multiple frames, 3-45
 Turn Readouts On or Off, Time Stamps, 3-46
 Using FastFrame Acquisitions, 3-43
 FastFrame Mode, Using, 3-44
FastFrame Setup, Horizontal menu, 3-44, 3-48
 FFT math waveform
 phase suppression, 3-179
 procedure for displaying, 3-175
 FFT Source, 3-175
 file formats, 3-196
 File menu
 command summary, D-1
 Delete All Refs, D-1
 Display On/Off, D-1
 Export, D-2
 Export Setup, D-1
 Full Screen, D-2
 Graticule, D-2
 Instrument Setup, D-1
 Label, D-1
 Measurements, D-2
 Minimize, D-2
 Page Setup, D-1
 Position/Scale, D-1
 Print, D-1
 Print Preview, D-1
 Recall Default Setup, D-1
 Recall Wfm, D-1
 Recent Setup File, D-2
 Reference Setup, D-1
 Reference Waveforms, D-1
 Run Application, D-1
 Save Wfm, D-1
 Select for Export, D-2
 Shutdown, D-2
 Waveform, D-2
 FINE button, 3-127
 Firmware, upgrade, 1-3
 Flat Panel Display Cleaning, C-1
 Flattop2 window, 3-160, 3-162, 3-169
 Force Trigger button, 3-61
 Frame graticule style, 3-106

frame, Horizontal menu, 3-45
 Frame graticule command, D-6
Frame Count, Horizontal menu, 3-45
Frame Length, Horizontal menu, 3-44
Frame, Horizontal menu, 3-46, 3-47
 Frequency, B-1, D-7, Glossary-4
 frequency domain controls, 3-151
 center, 3-155
 resolution bandwidth, 3-155
 span, 3-154
 frequency domain, averaging, 3-172
 Front panel, controls, 2-4
 Front panel
 connectors, 2-3
 description, 2-3
 Full graticule command, D-6
 Full graticule style, 3-106
 Full Screen command, D-2, D-3, D-4

G

gate controls, 3-153
 gate position, defined, 3-153
 gate width, and resolution bandwidth, 3-155
 Gated Measurements, Glossary-4
 gating
 and localizing measurements, 3-122
 controls, 3-151
 Gating command, D-8
 Gating control window, 3-122
 Gaussian window, 3-160, 3-162, 3-164
 General purpose knob, Glossary-7
 Glitch either trigger, Glossary-4
 Glitch negative trigger, Glossary-4
 Glitch Setup, D-5
 Glitch trigger, 3-62, Glossary-4
 Level, 3-68
 Mode and holdoff, 3-69
 Polarity, 3-68
 setting up, 3-68
 Source, 3-68
 Width, 3-68
 GND coupling, 3-6, 3-9
 GPIB, Glossary-4
 Configuration, D-10
 online guide, 1-11
 remote communication, 3-207
 GPIB Configuration control window, 3-207, D-10
 GPIB online help, 3-209
 Graticule command, D-2
 Graticule Style, 3-106
 graticule, defined, 3-100, Glossary-4

Graticule Split, 3-111, 3-112
Graticule Split button, 3-102
Graticule Style command, D-6
Grid graticule command, D-6
Grid graticule style, 3-106
Ground coupling, Glossary-4
group delay, defined, 3-159

H

Hamming window, 3-160, 3-161, 3-166
Hanning window, 3-160, 3-161, 3-167
Hard copy, Glossary-4
H-bars command, D-7

Help

full-text search, 3-212
In-depth Contextual Overviews, 3-210
Restore Help button, 3-210
Using Online Help, 3-209
Using WinHelp, 3-211

Help button, 3-210

Help menu

About TekScope, D-11
command summary, D-10
Contents and Index, D-10
Customer Feedback, D-11
Help on Window, D-10
Restore Help, D-10
Specifications, D-10
Technical Support, D-10

Help on Window, D-10

HF REJ coupling, 3-56

Hi Res mode, 3-21

defined, Glossary-5

High, B-1, Glossary-5

High Level, D-7

High/Low Method, 3-117

histogram, 3-121, 3-130

box, 3-130, 3-133

counting and display, 3-132

view and measurement data, illustrated, 3-131

limit controls, 3-133

resetting, 3-132

scaling, 3-133

sources, 3-130

Histogram control window, 3-132

histogram counting

resetting, 3-132

starting, 3-132

Histogram Measurements, D-8

histograms, 3-43

Hits in Box, B-2, D-8

Holdoff command, D-5

holdoff

Default, 3-59

for video triggers, 3-90

Time, 3-59

trigger, 3-59

Holdoff control window, D-5

Holdoff, trigger, Glossary-5

Horiz/Acq menu

Acquisition Mode, D-4

Autoset, D-4

command summary, D-4

Delay Mode On, D-4

Equivalent Time Auto, D-4

Fast Acquisitions, D-4

FastFrame Controls, D-4

FastFrame Setup, D-4

Horizontal/Acquisition Setup, D-4

Position/Scale, D-4

Resolution, D-4

Roll Mode Auto, D-4

Run/Stop, D-4

Zoom Controls, D-4

Zoom Graticule, D-4

Zoom Lock, D-4

Zoom Setup, D-4

Horizontal, Bar cursors, Glossary-5

horizontal acquisition window

illustrated, 3-18

parameters, 3-18

parameters, relationship, 3-19

Horizontal and Acquisition Setup window, D-4

Horizontal and acquisition system specifications, A-11

horizontal cursors, 3-124

horizontal delay

and triggering, 3-94

defined, 3-18

Horizontal menu

FastFrame Setup, 3-44, 3-48

Frame Count, 3-45

Frame Length %, 3-44

Frame %, 3-45, 3-46, 3-47

horizontal position, 3-7

and displaying waveforms, 3-103

and math waveforms, 3-148

and triggering, 3-53

defined, 3-18, 3-31

horizontal position and delay, uses for, 3-5

Horizontal Position/Display control window, D-4

horizontal reference, defined, 3-100, Glossary-5

horizontal scale, and math waveforms, 3-148

horizontal scale, 3-7, 3-19
 definition, 3-18
 horizontal scale and offset, setting up, 3-18
 Horizontal/Acquisition Setup, D-4
 horizontal scale readout, defined, 3-100

I

impulse response testing, 3-160
 including comments with saved waveforms, 3-189
 Incoming Inspection Procedure, 1-19
 incompatible acquisition modes, 3-24
 Independent cursors command, D-7
 Independent vs. Shared Window, 3-20
 Infinite persistence, 3-106
 Initialize, Glossary-5
 Input channel model, 3-4
 Input Conditioning Background, 3-14
 input coupling, 3-9
 AC, 3-9
 DC, 3-9
 GND, 3-9
 Input/output port specifications, A-17
 Installation, 1-5
 incoming inspection procedure, 1-19
 option, D-10
 software installation, 1-10
 Instrument Calibration control window, D-10
 Instrument Diagnostics, D-10
 Instrument ID, D-11
 Instrument Setup command, D-1
 Instrument Setup control window, 3-185, 3-187, D-1
 instrument setups, 3-183
 integral math waveforms, 3-142
 applications, 3-142
 derivation of, 3-142
 record length of, 3-143
 integrated thermal printer, 3-205
 lever, 3-207
 printing to, 3-206
 intensified samples, 3-107, D-6
 Intensity, Glossary-5
 intensity, waveform, 3-108
 INTENSITY knob, 3-40, 3-108
 interleaving channels, 3-35
 defined, Glossary-5
 interpolation, 3-34, 3-108, 3-109
 defined, Glossary-5
 linear, 3-34
 Sin(x)/x, 3-34
 Introduction, to this manual, xiii
 Invert command, D-3

Inverting channel waveforms, 3-9
 IRE graticule command, D-6
 IRE graticule style, 3-106

J

JPEG file format, 3-196

K

Kaiser-Bessel window, 3-160, 3-161, 3-167
 Keypad Defaults, 3-60
 Knob, General purpose, Glossary-7

L

Label command, D-1, D-3, D-8, D-9
 LCD backlight, 3-108
 LCD Backlight Timeout, 3-108
 LCD display contrast, 1-17
 Display menu
 Appearance, D-6
 Colors, D-6
 command summary, D-6
 Cross-Hair, D-6
 Display Date and Time, D-6
 Display Format, D-6
 Display Palette, D-6
 Display Persistence, D-6
 Display Setup, D-6
 Display Style, D-6
 Dots, D-6
 Frame, D-6
 Full, D-6
 Graticule Style, D-6
 Grid, D-6
 Infinite Persistence, D-6
 Intensified Samples, D-6
 IRE, D-6
 LCD Save Enabled, D-6
 Linear, D-6
 Monochrome Gray, D-6
 Monochrome Green, D-6
 mV, D-6
 No Persistence, D-6
 Normal, D-6
 Objects, D-6
 Screen Text, D-6
 Sin(x)/x, D-6
 Spectral Grading, D-6
 Temperature Grading, D-6

- Variable Persistence, D-6
- Vectors, D-6
- Waveform Interpolation, D-6
- LCD Save Enabled, D-6
- level, trigger, 3-53
- LEVEL knob, 3-53, 3-55, 3-68, 3-104
- Level presets, 3-60
 - A Trigger, 3-60
- LF REJ coupling, 3-56
- light printouts, 3-207
- line, trigger input, 3-55
- Linear command, D-6
- Linear interpolation, 3-108, 3-109, Glossary-6
- linear interpolation, 3-34
- linear magnitude, 3-157
- locking the Zoom focus, D-4
- Logic Pattern Setup, D-5
- Logic State Setup, D-5
- Logic trigger, 3-51, 3-64, 3-72
 - defined, 3-64
 - Pattern, Glossary-6
 - State, Glossary-6
- Long trigger level marker, 3-108
- Low, B-1, Glossary-6
- low frequency compensation, E-5
- Low Level, D-7

M

- magnitude spectral waveform, creating, 3-177
- Magnitude Spectrum, D-9
- Magnitude Spectrum command, D-8
- Manuals
 - part numbers, 1-33
 - related, xiv
- manuals, using, 3-209
- Math
 - applying to waveforms, 3-146
 - available operations, 3-137
 - functions available, 3-137
 - overview, 3-135
 - unavailable operations, 3-138
 - using measurements in math expressions, 3-138
 - waveform, illustrated, 3-135
- Math Averaging control window, D-9
- Math colors, 3-108
- math expressions, using, 3-138
- Math menu
 - Ch1 - Ch2, D-9
 - Ch1 * Ch2, D-9
 - Ch3 - Ch4, D-9
 - Ch3 * Ch4, D-9
- command summary (Standard), D-8
- Display On/Off, D-8, D-9
- Equation Editor, D-9
- Label, D-8, D-9
- Magnitude Spectrum, D-8, D-9
- Math Setup, D-8, D-9
- Phase Spectrum, D-9
- Position/Scale, D-8, D-9
- Set Math Averages, D-9
- Spectral Controls, D-9
- Spectral Setup, D-9
- Math menu , command summary (Advanced), D-9
- Math Parameters control window, 3-147
- Math Setup command, D-8, D-9
- Math Setup control window, 3-101, 3-144, 3-174, 3-175, 3-176, D-8, D-9
- Math Waveforms
 - Advanced Analysis option, 3-145
 - and vertical offset, 3-142
 - and vertical position, 3-142
 - and vertical scale, 3-142
 - averaging, 3-147
 - applying an expression to a waveform, 3-144
 - building an expression, 3-146
 - creating, 3-138
 - Creating a Math Waveform, 3-144, 3-145
 - Creating and Using Math Waveforms, 3-135
 - Cursor Measurements, 3-141
 - Defining Math Waveforms, 3-136
 - Defining Spectral Math Waveforms. *See* Spectral Math
 - derivative. *See* Derivative math waveform
 - derivative math waveforms, illustrated, 3-141
 - Differentiation, 3-140
 - displaying, 3-148
 - Equation Editor, 3-145
 - expression syntax, 3-139
 - FastFrame, 3-138
 - functional transformation of an acquired waveform, illustrated, 3-136
 - integral. *See* Integral math waveform
 - Math expressions and the math waveforms produced, 3-138
 - Math Parameters control window, 3-147
 - Math Setup control window, 3-144, 3-145
 - Operations on Math Waveforms, 3-147
 - Other Uses for Math Waveforms, 3-138
 - peak-peak amplitude measurement of a derivative waveform, illustrated, 3-142
 - Predefined Expression, 3-145
 - selecting a math function, 3-146
 - selecting a math waveform, 3-144, 3-145

- selecting an expression, 3-145
- setting scale and position, 3-149
- source dependencies, 3-139
- sources, 3-139
- spectral analysis of an impulse, illustrated, 3-136
- spectral math waveforms, 3-151
- Standard Math versus Advanced Math, 3-137
- taking cursor measurements, 3-150
- taking automatic measurements, 3-149
 - entering an expression, 3-144
 - defining/editing a Math Expression, 3-146
 - Displaying and Measuring Math Waveforms, 3-148
 - Using Math, 3-138
 - Waveform Differentiation, 3-140
 - waveform integration, 3-142
- MathCad header format, 3-196
- MathCad file format, 3-196
- MATLAB file format, 3-196
- Max, 3-120
- Maximum, B-1, D-7, D-8, Glossary-6
- Mean, 3-120, B-1, B-2, D-7, D-8, Glossary-6
- Mean +- 1 StdDev, B-3
- Mean +- 2 StdDev, B-3
- Mean +- 3 StdDev, B-3
- Measure menu
 - Amplitude, D-7
 - Area, D-7
 - Burst Width, D-7
 - command summary, D-7
 - Cycle Area, D-7
 - Cycle Mean, D-7
 - Cycle RMS, D-7
 - Delay, D-7
 - Display Statistics, D-8
 - Fall Time, D-7
 - Frequency, D-7
 - Gating, D-8
 - High Level, D-7
 - Histogram Measurements, D-8
 - Hits in Box, D-8
 - Low Level, D-7
 - Maximum, D-7, D-8
 - Mean, D-7, D-8
 - Mean +-1 StdDev, D-8
 - Mean +-2 StdDev, D-8
 - Mean +-3 StdDev, D-8
 - Measurement Setup, D-7
 - Median, D-8
 - Minimum, D-7, D-8
 - More, D-7
 - Neg Duty Cycle, D-7
 - Neg Overshoot, D-7
 - Negative Width, D-7
 - Peak Hits, D-8
 - Peak to Peak, D-8
 - Peak-to-Peak, D-7
 - Period, D-7
 - Phase, D-7
 - Pos Duty Cycle, D-7
 - Pos Overshoot, D-7
 - Positive Width, D-7
 - Reference Levels, D-8
 - Reset Histograms, D-8
 - Rise Time, D-7
 - RMS, D-7
 - Snapshot, 3-122, D-7
 - Standard Deviation, D-8
 - Time, D-7
 - Value, D-8
 - Value Count, D-8
 - Value Mean, D-8
 - Value Statistics, D-8
 - Waveform Histograms, D-8
- Measurement, Glossary-6
 - Amplitude, B-1, Glossary-1
 - Area, B-1, Glossary-1
 - Burst Width, B-1
 - Burst width, Glossary-2
 - Cycle Area, B-1, Glossary-3
 - Cycle Mean, B-1, Glossary-3
 - Cycle RMS, B-1, Glossary-3
 - Delay, Glossary-3
 - Duty cycle, Glossary-7, Glossary-8
 - Fall Time, B-1
 - Frequency, B-1, Glossary-4
 - Gated, Glossary-4
 - High, B-1, Glossary-5
 - Hits in Box, B-2
 - Low, B-1, Glossary-6
 - Maximum, B-1, Glossary-6
 - Mean, B-1, B-2, Glossary-6
 - Mean +- 1 StdDev, B-3
 - Mean +- 2 StdDev, B-3
 - Mean +- 3 StdDev, B-3
 - Median, B-2
 - Minimum, B-2, Glossary-7
 - Negative duty cycle, B-2
 - Negative overshoot, B-2
 - Negative Width, B-2
 - Overshoot, Glossary-8
 - Peak Hits, B-3
 - Peak-to-Peak, B-2, Glossary-8
 - Period, B-2, Glossary-8
 - Phase, B-2, Glossary-8
 - Pk-Pk, B-3
 - Positive duty cycle, B-2

- Positive overshoot, B-2
 - Positive width, B-2
 - Propagation delay, B-1
 - Rise Time, B-2, Glossary-9
 - RMS, B-2, Glossary-9
 - StdDev, B-2
 - Undershoot, Glossary-7
 - Waveform Count, B-3
 - Width, Glossary-7, Glossary-8
 - Measurement command, D-2
 - measurement definitions, B-1
 - Measurement Features, A-3
 - Measurement Gating, 3-123
 - Measurement Gating control window, D-8
 - Measurement Setup, D-7
 - Measurement Setup control window, 3-119, 3-120, 3-121, 3-149, D-7
 - measurement statistics, 3-120
 - defined, Glossary-6
 - Measurement tracking, Glossary-6
 - Measurements command, D-2
 - measurements
 - automated, 3-115
 - cursor, 3-124
 - Measuring Waveforms, 3-115
 - Absolute Reference, 3-117
 - annotating waveforms on the screen, 3-115
 - changing cursor position, 3-129
 - using cursors, 3-123
 - cursor types, 3-124, 3-125
 - customizing measurements, 3-116
 - displaying measurement statistics, 3-120
 - FastFrame, 3-116
 - gating, 3-116, 3-122
 - High/Low Method, 3-117
 - histogram, 3-117, 3-121
 - Histogram Measurements, 3-133
 - horizontal cursors, 3-124
 - Indep (independent) cursor, 3-129
 - Localizing a Measurement, 3-122
 - Max, 3-120
 - maximum number of measurements, 3-116
 - Mean, 3-120
 - measurement categories, 3-116
 - Min, 3-120
 - Min-max, 3-117
 - paired cursors, 3-124
 - partial waveform measurements, 3-116
 - Reference Levels Method, 3-117
 - Reference level calculation methods, 3-118
 - Relative Reference, 3-117
 - removing measurements, 3-120
 - selecting a cursor type, 3-128
 - selecting measurement parameters, 3-116
 - selecting the cursor sources, 3-128
 - selecting a source waveform, 3-119
 - setting cursor tracking, 3-129
 - Set histogram display options, 3-133
 - Set histogram limit controls, 3-133
 - setting histogram source and type, 3-132
 - setting measurement reference levels, 3-121
 - Setting the Cursor Sources, 3-128
 - split cursors, 3-124
 - Standard Deviation, 3-120
 - Starting and Resetting Histogram Counting, 3-132
 - statistics, 3-116
 - Take Measurements on a Frame, 3-116
 - taking a snapshot of measurements, 3-122
 - Taking Automatic Measurements, 3-115, 3-119
 - Taking Cursor Measurements, 3-124
 - Tracking, cursor, 3-129
 - Using Automatic Measurements, 3-116
 - Using Cursors, 3-125
 - Using Histograms, 3-130
 - vertical cursors, 3-124
 - Zoom, 3-116, 3-123
 - Mechanical specifications, A-19
 - Median, B-2, D-8
 - menu bar commands, D-1
 - Min, 3-120
 - Minimize command, D-2
 - minimizing the application , 3-210
 - Minimum, B-2, D-7, D-8, Glossary-7
 - mode, sampling, 3-31-3-33
 - Mode command, D-5
 - Mode control window, D-5
 - mode, acquisition, D-4
 - Model numbers, 1-1
 - Monochrome Gray command, D-6
 - Monochrome Gray color palette, 3-107
 - Monochrome Green command, D-6
 - Monochrome Green color palette, 3-107
 - More command, D-7
 - Multipurpose knobs, D-10
 - mV graticule style, 3-106
 - mV graticule command, D-6
- ## N
- NAND, Glossary-7
 - nearest side lobe, defined, 3-163
 - Neg Duty Cycle, D-7
 - Neg Overshoot, D-7
 - NEG trigger slope, 3-54
 - Negative duty cycle, B-2

Negative overshoot, B-2
 Negative Width, B-2, D-7
 network access, 1-12
 noise
 reducing in phase FFTs, 3-179
 reducing in phase waveforms, 3-159
 NOISE REJECT coupling, 3-56
 NOR, Glossary-7
 NORM trigger mode, 3-56
 Normal color palette, 3-107
 Normal trigger mode, 3-51, 3-56, Glossary-7
 illustrated, 3-50
 Normal command, D-6
 NTSC video signals, displaying, 3-106
 Numeric file format, 3-196
 Nyquist frequency, 3-172

O

Objects command, D-6
 Offset, DC. *See* DC Offset
 Offset command, D-3
 offset, vertical, 3-14
 Online help, 3-209
 operating requirements, 1-6
 optimizing gain and offset accuracy, E-4
 Optimizing Measurement Accuracy
 Compensating Low Frequency Probes, E-5
 Compensating the Oscilloscope, E-1
 Connecting Probes for Calibration, E-3
 Deskewing Channels, E-6
 option
 installation, 1-12
 key, 1-12
 software, 1-12
 Option Installation command, D-10
 Optional accessories, 1-34
 Options, 1-31
 Option installation key, D-11
 Options list, D-11
 OR, Glossary-7
 oscilloscope
 definition, Glossary-7
 features, A-1
 specifications, A-1
 Overshoot, Glossary-8
 overwriting data, 3-185

P

page preview, 3-205
 Page Setup, D-1

Page Setup dialog box, 3-205, 3-206, D-1
 Paired cursors command, D-7
 paired cursors, 3-124
 Pattern trigger, 3-63
 Input Threshold, 3-79
 logic, 3-79
 Pattern Type, 3-79
 setting up, 3-79
 Trigger When Pattern, 3-80
 Trigger When Time, 3-81
 Peak Detect mode, 3-21
 defined, Glossary-8
 Peak Hits, B-3, D-8
 Peak to Peak command, D-8
 Peak-to-Peak, B-2, D-7, Glossary-8
 Performance verification, 1-11
 file system test, 1-29
 functional tests, 1-21
 self tests, 1-20
 time base test, 1-25
 trigger test, 1-27
 Period, B-2, D-7, Glossary-8
 peripherals, connecting, 1-6
 Persistence, defined, Glossary-8
 Phase, B-2, D-7, Glossary-8
 data, displaying, 3-151
 spectral waveform, creating, 3-177
 suppression, 3-159
 Phase Spectrum, D-9
 Phone number, Tektronix, xv
 Pixel, Glossary-8
 Pk-Pk, B-3
 Polarity, 3-75
 pop-up keyboard, 3-186
 Pos Duty Cycle, D-7
 Pos Overshoot, D-7
 POS trigger slope, 3-54
 position
 horizontal, D-4
 vertical, D-3
 POSITION knob, 3-102, 3-104
 positioning gates, 3-123
 Position/Scale command, D-1, D-3, D-4, D-8, D-9
 Position/Scale control window, D-1, D-3, D-8, D-9
 Positive duty cycle, B-2
 Positive overshoot, B-2
 Positive Width, D-7
 Positive width, B-2
 posttrigger, 3-50, 3-53
 defined, Glossary-8
 On/Standby switch, 1-8, 1-9
 Power source specifications, A-19
 powering down, 1-9

- powering on, 1-8
- Predefined Expressions, 3-145
- preferences, D-10
- pretrigger, 3-50, 3-53
 - defined, Glossary-9
- Preventing Aliasing, 3-23
- Print command, D-1
- PRINT button, 3-205
- Print dialog box, 3-205, D-1
- Print Preview, 3-206, D-1
- printing
 - banners, 3-205, 3-206
 - from the front panel, 3-205
 - from the Menu Bar, 3-205
 - page format, 3-205
 - Print Preview, 3-205
 - screen copy, 3-205
 - summary waveform, 3-206
 - to the Windows clipboard, 3-207
 - using cursors, 3-206
 - waveforms, 3-205
- printing problems, 3-207
- probe
 - calibration, E-3
 - compensate timing, E-7
 - defined, Glossary-9
 - gain and offset accuracy, E-4
 - low frequency compensation, E-5
- Probe Cal, D-3
- Probe Cal control window, D-3
- Probe compensation, defined, Glossary-9
- Probe-channel deskew, Glossary-2
- probes
 - selecting, 3-5
 - supported, 1-4
- Probes and Signal Connection, 3-5
- Product
 - accessories. *See* Accessories
 - description, 1-1
 - models, 1-1
 - software, 1-2
 - unpacking, 1-5
- Product and Feature Description, A-1
- Product support, contact information, xv
- programmer help, 1-11
- programmer online guide, 3-209
- Propagation delay, B-1
- Pulse trigger, 3-51, Glossary-9

Q

- Quick Select, D-5

- quitting the application, 1-12

R

- radians, using as phase units, 3-179
- readout, trigger, 3-57, 3-62
- READY status light, 3-57
- Real-time sampling, 3-26, 3-32
- Real-time sampling, Glossary-9
- Rear panel connectors, 2-7
- Recall Default Setup, D-1
- Recall Instrument Setup dialog box, 3-188
- Recall Instrument Setups control window, 3-183
- Recall Wfm, D-1
- recalling a setup, 3-183
- recalling a setup, D-2
- recalling a waveform, 3-189
- record length, 3-19, 3-152
 - defined, 3-31, Glossary-9
 - setting, 3-11
- Rectangular window, 3-160, 3-161, 3-165
- Reference
 - Levels Method, 3-117
 - memory, Glossary-9
- Reference waveforms, defined, Glossary-9
- Reference Colors, 3-107
- reference level, setting, 3-178
- Reference Level Offset, 3-157
- reference level offset
 - defined, 3-157
 - setting, 3-178
- Reference Levels command, D-8
- reference levels, 3-121
 - units, 3-121
- Reference Levels control window, D-8
- Reference Levels setup control window, 3-121
- Reference Setup, D-1
- Reference Setup control window, 3-101, 3-189, 3-190, 3-194, D-1
- Reference Waveforms, D-1
- Related Manuals, xiv
- Relative Reference, 3-117
- Release Notes, 1-10
- remote communication, 3-207
- removing measurements, 3-120
- Reset Histograms, D-8
- Resetting the Oscilloscope, 3-13
- Resolution command, D-4
- resolution, 3-7, 3-19, 3-152
 - deriving, 3-20
- resolution bandwidth, 3-155
 - defined, 3-162

- setting, 3-180
- Resolution control window, D-4
- RESOLUTION knob, 3-20, 3-102, 3-104
- Restore Help, D-10
- Restore Help button, 3-210
- Rise Time, B-2, D-7, Glossary-9
- RMS, B-2, D-7, Glossary-9
- Roll Mode, and math waveforms, 3-138
- roll mode
 - illustrated, 3-23
 - untriggered, 3-22
 - untriggered, with single sequence, 3-23
 - using, 3-28
- Roll Mode Auto command, D-4
- Roll mode, and measurements, 3-119
- Run Application command, D-1
- RUN/STOP, 3-43
- Run/Stop command, D-4, D-5
- RUN/STOP button, 3-22, 3-26, 3-61
- Run/Stop control window, D-4, D-5
- Runs After delayed trigger mode, 3-91
- Runt Setup, D-5
- Runt trigger, 3-62, Glossary-9
 - logic, 3-72
 - Polarity, 3-71
 - setting up, 3-70
 - Source, 3-70
 - threshold levels, 3-72
 - Trigger When Runt, 3-72

S

- Sample mode, 3-21
- sample interval, 3-19, 3-31
 - defined, Glossary-10
 - deriving, 3-20
 - setting, 3-11
- Sample mode, defined, Glossary-9
- sample rate
 - deriving, 3-20
 - maximum, 3-35
- Sampling, Glossary-10
- sampling, 3-32
 - process, defined, 3-30-3-35
 - process, illustrated, 3-30-3-35
- sampling and acquisition mode, 3-33
- Save Instrument Setup As dialog box, 3-186
- Save Instrument Setups control window, 3-183
- Save Wfm, D-1
- saving a setup, 3-183, 3-185
- saving a waveform, 3-189
- saving a waveform to a reference, 3-190

- scale
 - horizontal, D-4
 - vertical, D-3
- SCALE knob, 3-102, 3-104
- scallop loss, 3-161, 3-162
- Screen saver, 3-108
- Screen text, Glossary-10
- Screen Text command, D-6
- Screen Text command, 3-107
- Select for Copy command, D-2
- Select for Export, D-2
- Selecting the acquisition mode, 3-25
- selecting Zoom, 3-111
- Sequential Triggering, 3-91
- Serial number, D-11
- Service support, contact information, xv
- Set Date & Time, 3-207
- Set Math Averages, D-9
- Setting the vertical acquisition window, 3-10
- Set Time & Date, D-10
- Set Time and Date control window, D-10
- Setting Acquisition Controls, 3-21
- Setting Up Signal Input, 3-8
- Setting up the acquisition window, 3-14
- Setting up Triggers, 3-54
- Setting vertical range and position, 3-16
- Setting waveform count, 3-25
- Setup, dual display, 1-13
- setup
 - adding comments, 3-183
 - naming, 3-186
 - recalling, 3-183
 - saving, 3-183
- Setup/Hold Setup, D-5
- Setup/Hold trigger, 3-65
 - Data Source, 3-84
 - negative setup or hold times, 3-65
 - positive setup or hold times, 3-65
 - setting up, 3-84
 - Trigger Inside Violation, 3-85
 - trigger point location, 3-65
- Setup/hold trigger
 - Clock Edge, 3-84
 - Clock Level, 3-85
 - Clock Source, 3-84
 - Data Level, 3-85
- Short trigger level marker, 3-108
- shutdown, 1-9
- Shutdown command, D-2
- Side panel connectors, 2-7
- Signal Connection and Conditioning, 3-4
- Signal path compensation, 1-20, A-1

- Signal Processing Features, A-2
- Sin(x)/x command, D-6
- Sin(x)/x interpolation, 3-34, 3-108, 3-109, Glossary-6
- SINGLE button, 3-22, 3-26, 3-61
- Single sequence triggering, and acquisition mode, 3-61
- single-shot sampling, 3-32
- site considerations, 1-6
- Slew rate trigger, Glossary-10
- slope
 - defined, Glossary-10
 - trigger, 3-53
- SLOPE button, 3-53
- SLOPE controls, 3-54
- Snapshot
 - copying data, 3-204
 - exporting, 3-199
- Snapshot command, D-7
- Snapshot measurements, 3-122
- Software installation, 1-10
- SOURCE controls, 3-54
- span, defined, 3-154
- Specifications, A-1, D-10
 - certifications and compliances, A-21
 - channel input and vertical, A-5
 - conditions for, A-1
 - data storage , A-18
 - display, A-16
 - environmental, A-20
 - horizontal and acquisition system, A-11
 - input/output port , A-17
 - mechanical, A-19
 - power source, A-19
 - trigger, A-13
- Spectral Analysis Setup control window, 3-176
- spectral analyzer
 - control locks, 3-152
 - phase reference position, 3-158
 - phase unwrap, 3-158
- spectral analyzer controls, 3-152
 - frequency, 3-152, 3-154
 - gating, 3-152, 3-153
 - magnitude, 3-152, 3-157
 - dB, 3-157
 - dBm, 3-157
 - linear, 3-157
 - reference level, 3-157
 - phase, 3-152, 3-158
 - time, 3-152
 - duration, 3-152
 - resolution, 3-152
- spectral averaging, 3-151
- Spectral Controls, D-9
- Spectral Grading color palette, 3-107
- Spectral Grading command, D-6
- spectral magnitude data, displaying, 3-151
- Spectral Math
 - 3 dB BW in bins, 3-162
 - acquisition mode, 3-172
 - aliasing, 3-172
 - averaging, 3-172
 - Blackman-Harris, 3-160, 3-162
 - Blackman-Harris window, 3-167
 - center frequency, 3-155, 3-180
 - coefficients, 3-163
 - coherent gain, 3-162
 - dB scale, 3-175, 3-178
 - dBm, 3-157
 - dBm scale, 3-175, 3-178
 - Defining A Spectral Math Waveform, 3-175, 3-176
 - Defining Spectral Math Waveforms, 3-151
 - Definition of gate parameters, illustrated, 3-154
 - duration, 3-181
 - Duration and resolution control effects, illustrated, 3-153
 - Effects of adjusting the reference level offset control, illustrated, 3-158
 - Effects of adjusting the reference level, illustrated, 3-157
 - Effects of frequency domain control adjustments, illustrated, 3-156
 - Effects of trigger jitter, 3-171
 - Example of scallop loss for a Hanning Window without zero fill, illustrated, 3-163
 - Example of the effects of setting the Phase Suppression Threshold, illustrated, 3-159
 - Flatop2 window, 3-160, 3-162, 3-169
 - frequency range, 3-180
 - gate controls, 3-153
 - gate duration, 3-181
 - gate position, 3-181
 - Gaussian window, 3-160, 3-162, 3-164
 - group delay, 3-159
 - Hamming window, 3-160, 3-161, 3-166
 - Hanning window, 3-160, 3-161, 3-167
 - How aliased frequencies appear in a spectral waveform, illustrated, 3-173
 - impulse response testing, 3-160
 - Kaiser-Bessel window, 3-160, 3-161, 3-167
 - linear scale, 3-175, 3-178
 - nearest side lobe, 3-163
 - phase reference point, 3-181
 - phase reference position, 3-158
 - phase unwrap, 3-158
 - real and imaginary magnitudes, 3-158
 - Recognizing Aliasing, 3-172

- record length, 3-181
 - Rectangular window, 3-160, 3-161, 3-165
 - reducing noise, 3-179
 - reference level, 3-157
 - reference level offset, 3-157
 - resolution, 3-181
 - resolution bandwidth, 3-155, 3-180, 3-181
 - sample rate, 3-181
 - scale factor, 3-175, 3-178, 3-179
 - scallop loss, 3-162
 - selecting a predefined spectral analysis math function, 3-174
 - Selecting a Predefined Spectral Math Function, 3-174
 - selecting a source for a spectral waveform, 3-175
 - selecting a spectral waveform, 3-177
 - selecting the window type, 3-176, 3-180
 - setting the frequency domain controls, 3-180
 - setting the magnitude scale, 3-175, 3-178
 - setting the phase scale, 3-179
 - setting the time domain controls, 3-181
 - setting time and frequency domain control tracking, 3-179
 - spectral analyzer controls, 3-151
 - suppression threshold, 3-159
 - taking automated measurements, 3-173
 - taking cursor measurements, 3-173, 3-182
 - Tek Exponential window, 3-160, 3-162, 3-171
 - Tek Exponential window in the time and the frequency domains, illustrated, 3-171
 - Time and frequency domain graphs for the Flattop2 window, illustrated, 3-170
 - Time and frequency domain graphs for the Rectangular window, illustrated, 3-165
 - Time and frequency graphs for the Gaussian window, illustrated, 3-164
 - Time and frequency graphs for the Hanning Window, illustrated, 3-167
 - Time and frequency graphs for the Kaiser-Bessel window, illustrated, 3-168
 - Time and frequency graphs of the Blackman-Harris window, illustrated, 3-169
 - Time and frequency graphs of the Hamming window, 3-166
 - unwrapping phase, 3-179
 - Using Spectral Math Controls, 3-152
 - Using the Frequency Domain controls, 3-154
 - Using the gate controls, 3-153
 - Using the magnitude controls, 3-157
 - Using the phase controls, 3-158
 - Using the time controls, 3-152
 - Using windows to filter, 3-160
 - window characteristics, 3-160, 3-161
 - Windowing the time domain record, illustrated, 3-161
 - Zero Phase Reference, 3-163
 - Spectral Math control window, D-9
 - Spectral Math Setup control window, D-9
 - Spectral math waveform, undersampling, 3-172
 - spectral math waveform, phase suppression, 3-159
 - spectral math waveforms. *See* Spectral Math Spectral Setup, D-9
 - spectrum analyzer, 3-135
 - Split cursors command, D-7
 - split cursors, 3-124, 3-128
 - Spreadsheet file format, 3-196
 - Standard accessories, 1-33
 - Standard Deviation, 3-120, D-8
 - startup disk, creating, 1-9
 - State trigger, 3-63, 3-82
 - Input Threshold, 3-82
 - logic inputs, 3-82
 - Pattern Type, 3-83
 - setting up, 3-82
 - Trigger When Pattern, 3-83
 - Statistical measurement, Glossary-10
 - statistics, 3-120
 - on measurement results, 3-116
 - StdDev, B-2
 - supported measurements, B-1
 - system diagnostics, 1-20
 - System overview, 2-8
- ## T
- TDS5000 Series Programmer Online Guide, 3-209
 - TDS5000 specifications, A-1
 - Technical Support, D-10
 - Technical support, contact information, xv
 - Tek Exponential window, 3-158, 3-160, 3-162, 3-171
 - Tek Secure, D-10, Glossary-10
 - Tektronix, contacting, xv
 - TekVISA, 2-2
 - Temperature Grading command, D-6
 - Temperature Grading color palette, 3-107
 - Termination command, D-3
 - termination, 3-6, 3-8
 - Termination control window, D-3
 - Text file format, 3-196
 - thermal printer, 3-206
 - Time command, D-7
 - time base, 3-102
 - defined, Glossary-10
 - time cursor readout values, 3-126

- time domain controls, 3-151
- Time trigger holdoff, 3-59
- Timeout Setup, D-5
- Timeout trigger, Glossary-10
- Timeout trigger, 3-63
 - Level, 3-77
 - pulse threshold, 3-78
 - setting up, 3-77
 - Source, 3-77
 - Timer, 3-77
- Trace, Glossary-10
- Track cursors command, D-7
- Track Mode, 3-129
- Transition Setup, D-5
- Transition Time trigger, 3-62
 - Polarity, 3-75
 - setting up, 3-75
 - Source, 3-75
 - Threshold levels, 3-76
- Trigger menu
 - A Event (Main) Trigger Setup, D-5
 - A->B Trigger Sequence, D-5
 - B Event (Delayed) Trigger Setup, D-5
 - command summary, D-5
 - Edge Setup, D-5
 - Glitch Setup, D-5
 - Holdoff, D-5
 - Logic Pattern Setup, D-5
 - Logic State Setup, D-5
 - Mode, D-5
 - Quick Select, D-5
 - Run/Stop, D-5
 - Runt Setup, D-5
 - Setup/Hold Setup, D-5
 - Timeout Setup, D-5
 - Transition Setup, D-5
 - Width Setup, D-5
 - Window Setup, D-5
- TRIG'D status light, 3-57
- Trigger, Glossary-11
 - Edge, Glossary-3
 - Glitch, Glossary-4
 - level, Glossary-11
 - Runt, Glossary-9
 - Slew Rate, Glossary-10
 - Timeout, Glossary-10
- Trigger sources
 - AC Line Voltage, 3-50
 - auxiliary input, 3-50, 3-55
 - Input channel, 3-50
 - input channels, 3-55
 - Line, 3-55
- Trigger, trigger level marker, 3-108
- Trigger After Time, 3-95
 - defined, 3-91
 - setting up, 3-95
- trigger condition, defined, 3-18
- Trigger, 3-50
 - A Only, 3-95
 - AC Line Voltage, 3-55
 - after an A trigger, 3-95
 - after events, 3-96
 - Auxiliary, 3-50
 - Coupling, 3-52
 - delayed, 3-53
 - displays, 3-50
 - Edge, 3-51
 - Glitch, 3-62, 3-68
 - holdoff, 3-52, 3-59
 - level, 3-53
 - level indicator, 3-58
 - LEVEL knob, 3-55
 - Line, 3-50
 - Logic, 3-64
 - mode, 3-56
 - Pattern, 3-63, 3-79
 - posttrigger, 3-50, 3-53
 - pretrigger, 3-50, 3-53
 - readout, 3-57
 - Runt, 3-62, 3-70
 - selecting types, 3-54
 - Setup/Hold, 3-65, 3-84
 - SINGLE button, 3-61
 - slope, 3-53
 - slope and level illustrated, 3-53
 - sources, 3-50
 - State, 3-63, 3-82
 - status lights, 3-57
 - Timeout, 3-63, 3-77
 - Transition, 3-62, 3-75
 - Video, 3-67, 3-89
 - Width, 3-62, 3-73
 - Window, 3-67, 3-87
- Trigger Features, A-3
- Trigger holdoff, 3-52
 - illustrated, 3-52
- trigger jitter, effects, 3-171
- Trigger level
 - ECL, 3-60
 - TTL, 3-60
 - USER, 3-60
- trigger level indicator, 3-58
- Trigger Level Marker, 3-108
- trigger level marker, using to set threshold levels, 3-72, 3-76

- Trigger Modes, 3-51
 - Auto, 3-51
 - Normal, 3-51
 - Trigger on nth Event, defined, 3-91
 - trigger point, defined, 3-31
 - Trigger Setup control window, 3-55, 3-59, D-5
 - Trigger specifications, A-13
 - Trigger Types
 - Logic, 3-51
 - Pulse, 3-51
 - Video, 3-51
 - Triggering
 - Additional Trigger Parameters, 3-59
 - Advanced Triggering, 3-62
 - Checking Trigger Status, 3-57
 - Defining a time qualified Pattern trigger, 3-81
 - Defining clock source and edge, 3-84
 - Defining logic, 3-83
 - Defining logic state inputs, 3-82
 - Defining new trigger level presets, 3-60
 - Defining pattern inputs, 3-79
 - DELAY button, 3-53
 - Delayed Trigger System, 3-53
 - Forcing a trigger, 3-61
 - front-panel controls, 3-54
 - Horizontal Position, 3-53
 - LEVEL knob, 3-53
 - logic trigger defined, 3-64
 - overview of, 3-49
 - Selecting a preset trigger level, 3-60
 - Selecting the polarity, 3-73
 - Selecting the trigger mode, 3-56
 - Selecting the trigger slope, 3-54
 - Selecting the trigger source, 3-55
 - Selecting the trigger type, 3-54
 - Sequential Triggering, 3-91
 - Set the Level, 3-90
 - Set to 50%, 3-55
 - Setting holdoff, 3-59
 - Setting mode and holdoff, 3-69, 3-72, 3-74, 3-76, 3-78, 3-80, 3-83, 3-85, 3-88, 3-90
 - Setting the data and clock levels, 3-85
 - Setting the glitch trigger level, 3-68
 - Setting the pulse width trigger level, 3-73
 - Setting the setup and hold times, 3-85
 - Setting the timer, 3-77
 - Setting the transition time, 3-76
 - Setting the trigger coupling, 3-56
 - Setting the trigger level, 3-55
 - Setting threshold levels, 3-72
 - Setting threshold voltages, 3-79
 - Setting up B triggering, 3-96
 - Setting up Triggers, 3-54
 - Single sequence trigger, 3-61
 - Slope and Level, 3-53
 - SLOPE button, 3-53
 - The Trigger Event, 3-50
 - Defining the logic patterns, 3-79
 - Trigger on B Events, 3-96
 - Trigger Coupling, 3-52
 - Trigger Holdoff, 3-52
 - Trigger level from display, 3-58
 - Trigger Modes, 3-51
 - Trigger on A (Main) Only, 3-95
 - Trigger on a Glitch, 3-68
 - Trigger on a Runt Pulse, 3-70
 - Trigger on a Pattern, 3-79
 - Trigger on the Pulse Width, 3-73
 - Trigger on a Video Signal, 3-89
 - Trigger on B After Time, 3-95
 - Trigger on Logic State, 3-82
 - Trigger on Pulse Timeout, 3-77
 - Trigger on Setup/Hold Time Violations, 3-84
 - Trigger on Transition Time, 3-75
 - Trigger on Window Threshold Violations, 3-87
 - Trigger Sources, 3-50, 3-91
 - trigger status lights, 3-57
 - Trigger Types, 3-51, 3-91
 - Triggering Concepts, 3-50
 - Triggering from the Front Panel, 3-54
 - Triggering on a Sequence, 3-95
 - Triggering with Horizontal Delay Off, 3-92
 - Triggering with Horizontal Delay On, 3-93
 - Trigger status from acquisition readout, 3-57
 - Using Sequential Triggering, 3-91
 - Triggering from the Front Panel, 3-54
 - troubleshooting, cursors, 3-125
 - TTL, 3-68, 3-76, 3-77, 3-85
 - trigger level, 3-60
- ## U
- Undershoot, Glossary-7
 - Undo Last Autoset, 3-13, D-2
 - Update, software, 1-3
 - Upgrade, firmware, 1-3
 - URL, Tektronix, xv
 - USB devices, 1-7, 2-7
 - user files, backing up, 1-10
 - User interface, description, 2-5
 - User Preferences command, D-10
 - User Preferences control window, D-10
 - USER trigger level, 3-60
 - Using Auto-Increment Filename, 3-184
 - Using Spectral Math Controls, 3-152

Using the Waveform Display, 3-100

Utilities menu

- AUX Out Configuration, D-10
- command summary, D-10
- Deassign Multipurpose Knobs, D-10
- Display Recorder, D-10
- GPIB Configuration, D-10
- Instrument Calibration, 1-20, D-10, E-1
- Instrument Diagnostics, 1-20, D-10
- Option Installation, 1-12, D-10
- Set Time and Date, 3-109, D-10
- Tek Secure, D-10
- User Preferences, 3-60, D-10

V

Value, D-8

Value Count, D-8

Value Mean, D-8

Value Statistics, D-8

Variable persistence, 3-106

V-bars command, D-7

vectors, displaying waveforms as, 3-107

Verification, Incoming Inspection Procedure, 1-19

oscilloscope version number, where to find, D-11

Vertical acquisition window considerations, 3-14

vertical cursors, 3-124

and the trigger point, 3-125

vertical cursors, defined, Glossary-11

Vertical menu

- 50-50 Split, D-3
- 80-20 Split, D-3
- Attenuation, D-3
- Bandwidth, D-3
- command summary, D-3
- Coupling, D-3
- Deskew, D-3
- Display On/Off, D-3
- Invert, D-3
- Label, D-3
- Offset, D-3
- Position/Scale, D-3
- Probe Cal, D-3
- Termination, D-3
- Vertical Setup, D-3
- Zoom Controls, D-3
- Zoom Graticule, D-3
- Zoom Setup, D-3

vertical offset

- acquisition window position, 3-17
- and math waveforms, 3-139, 3-142, 3-143
- setting, 3-14

Vertical Offset control window, D-3

vertical position, 3-6, 3-15

and math waveforms, 3-142, 3-143, 3-149

vertical range, setting, 3-14

vertical scale and offset

illustrated, 3-16

uses for, 3-5

Vertical Setup command, D-3

Vertical Setup control window, D-3

Video trigger, 3-67

Autoset buttons, 3-89

Custom video format, 3-89

defined, 3-51

Graticule types, 3-90

Holdoff, 3-90

Polarity, 3-90

setting up, 3-89

Source, 3-89

Trigger On, 3-90

virtual keyboard, 3-183, 3-189, 3-191, 3-193, 3-195

W

Waveform command, D-2

waveform

adding notes, 3-115

clearing references, 3-194

clipping, 3-139

See also Clipping

copying, 3-196, 3-202

data formats, 3-203

defined, Glossary-11

differentiation, 3-140

display, 3-101

displaying, 3-99

exporting, 3-196, 3-197

FFTs, 3-151

file formats, 3-191, 3-196

files, using with applications, 3-196

image types, 3-203

integration, 3-142

intensity, 3-108

interval, Glossary-11

label, 3-190

measuring, 3-115

printing, 3-205

recalling, 3-189

recalling to a reference, 3-192

reference, recalling from a file, 3-193

saving, 3-189

saving to a file, 3-191

scale factors, 3-198

- selecting data to export, 3-198
 - using Zoom, 3-110
- Waveform Count, B-3
- Waveform Display control window, D-1, D-3, D-8, D-9
- Waveform Histogram setup window, D-8
- Waveform Histograms, D-8
- Waveform Interpolation command, D-6
- Waveform Interpolation command, 3-108
- Waveform Label control window, D-1, D-3, D-8, D-9
- waveform record, 3-31
 - illustrated, 3-32
 - spectral source, long versus short, 3-152
- waveform record length, definition, 3-18
- Web site address, Tektronix, xv
- Width Setup, D-5
- width
 - negative, Glossary-7
 - positive, Glossary-8
- Width trigger, 3-62
 - Level, 3-73
 - ranges, 3-73
 - setting up, 3-73
 - Source, 3-73
- window
 - bin width, 3-155
 - characteristics, 3-160, 3-161
 - functions, 3-151
 - selecting, 3-161
- Window Setup, D-5
- Window trigger, 3-67
 - defining limits, 3-88
 - logic inputs, 3-88
 - setting up, 3-87
 - Source, 3-87
 - threshold levels, 3-87
 - Trigger When, 3-88
- Windows operating system
 - backup tool, 1-10

- Display Properties, 1-14, 1-15
- reinstalling, 1-2

X

- XY format, 3-41
 - defined, Glossary-11
- XY format pairs, 3-42
- XYZ format, defined, Glossary-11
- XYZ format, 3-41

Y

- YT format, 3-41
 - defined, Glossary-11

Z

- zero fill, and scallop loss, 3-162
- zero phase reference point, 3-163
 - adjusting, 3-160
 - establishing for impulse testing, 3-163
- ZOOM button, 3-104, 3-110, 3-111
- Zoom, 3-123
- Zoom Setup command, D-3, D-4
- Zoom control window, 3-112, D-3, D-4
- Zoom Controls command, D-3, D-4
- Zoom Graticule, D-3, D-4
 - 50-50 Split, D-4
 - 80-20 Split, D-4
 - Full Screen, D-3, D-4
- Zoom
 - and waveforms, 3-110
 - graticule, 3-111
- Zoom Lock, 3-112, D-4
- Zoom Setup control window, 3-102, 3-111
- Zoom Setup control window, D-3, D-4

